

# Unit 2/106 Hyde Street

## Ground Floor

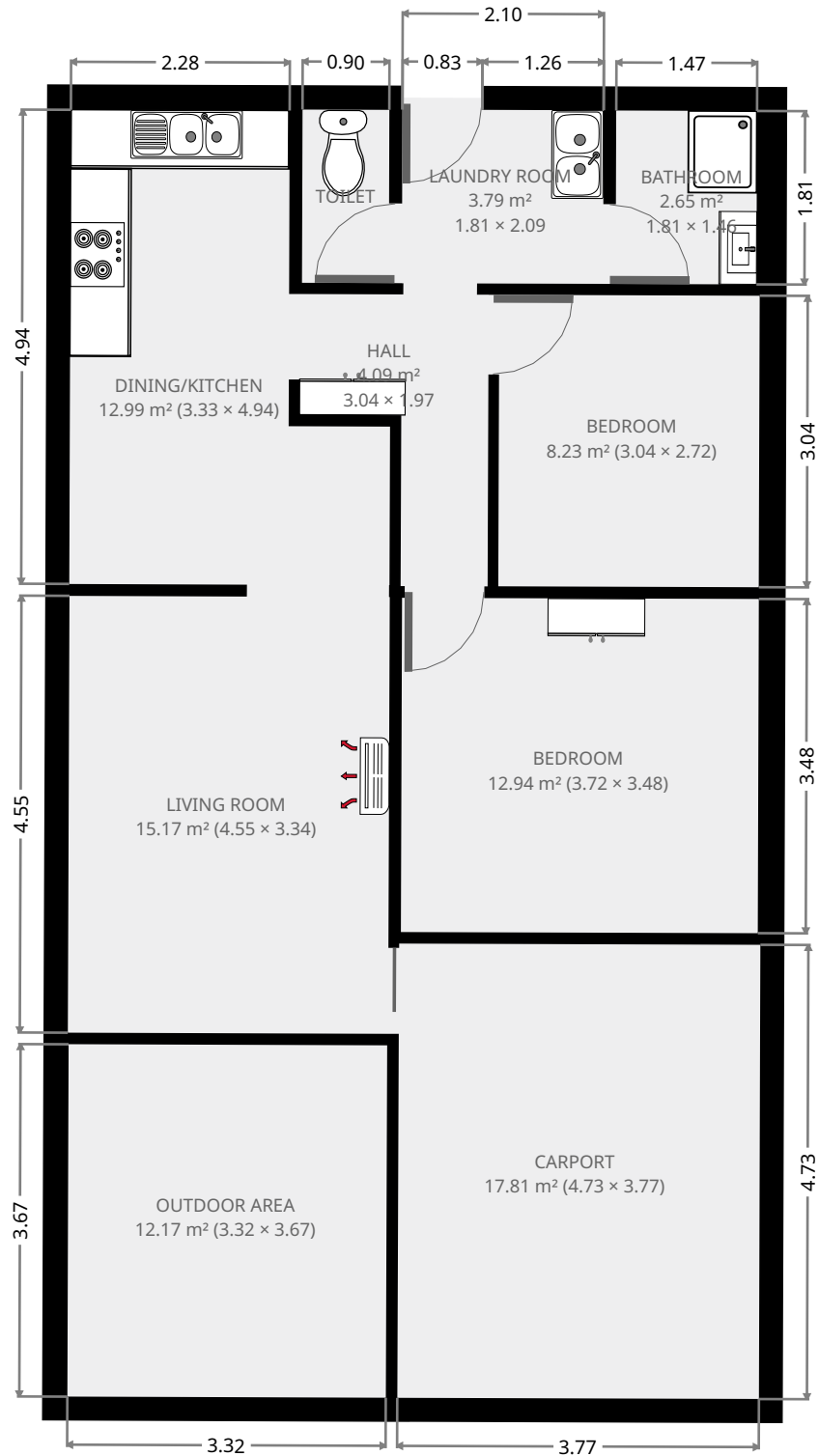

THIS FLOORPLAN IS PROVIDED WITHOUT WARRANTY OF ANY KIND. SENSOPIA DISCLAIMS ANY WARRANTY INCLUDING, WITHOUT LIMITATION, SATISFACTORY QUALITY OR ACCURACY OF DIMENSIONS.



# Unit 2/106 Hyde Street

## Living Room

Width: 3.34 m  
 Length: 4.55 m  
 Area: 15.17 m<sup>2</sup>  
 Perimeter: 15.77 m

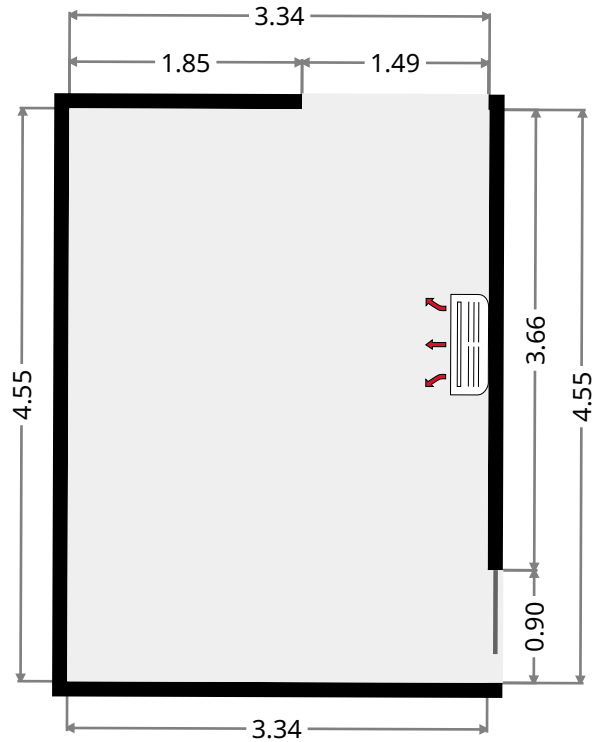
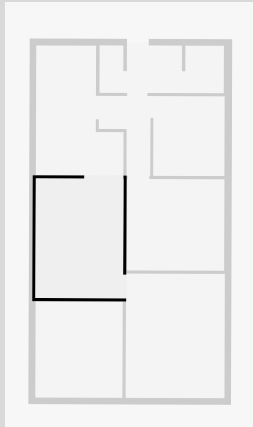

## Dining/Kitchen

Width: 3.33 m  
 Length: 4.94 m  
 Area: 12.99 m<sup>2</sup>  
 Perimeter: 16.54 m

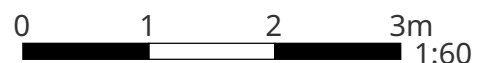
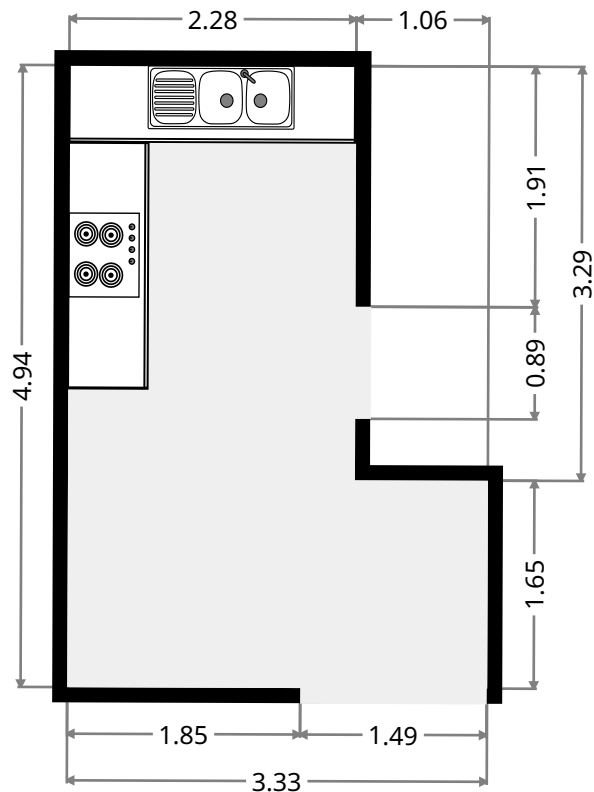
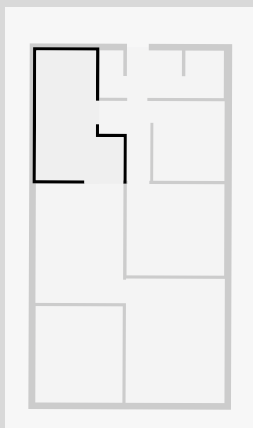

THIS FLOORPLAN IS PROVIDED WITHOUT WARRANTY OF ANY KIND. SENSOPIA DISCLAIMS ANY WARRANTY INCLUDING, WITHOUT LIMITATION, SATISFACTORY QUALITY OR ACCURACY OF DIMENSIONS.

# Unit 2/106 Hyde Street

## Hall

Width: 1.97 m  
 Length: 3.04 m  
 Area: 4.09 m<sup>2</sup>  
 Perimeter: 10.01 m

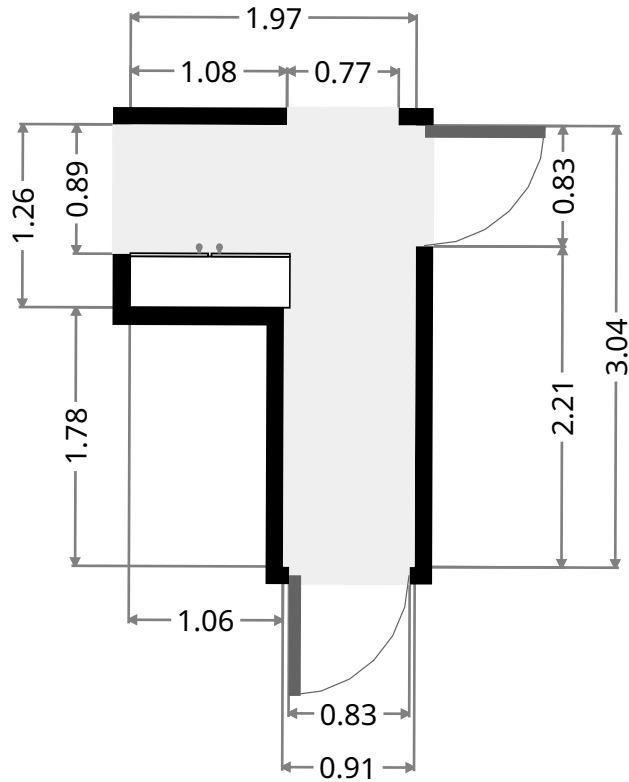
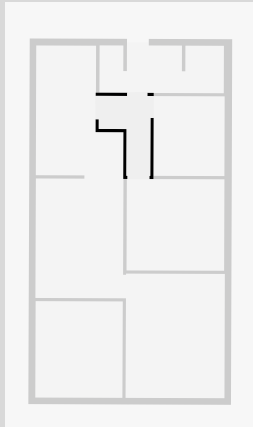

## Bedroom

Width: 3.48 m  
 Length: 3.72 m  
 Area: 12.94 m<sup>2</sup>  
 Perimeter: 14.40 m

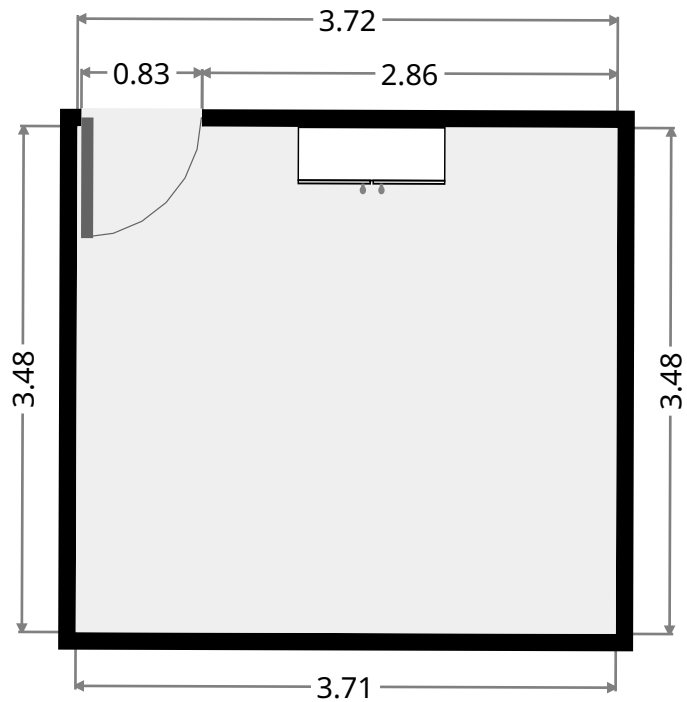
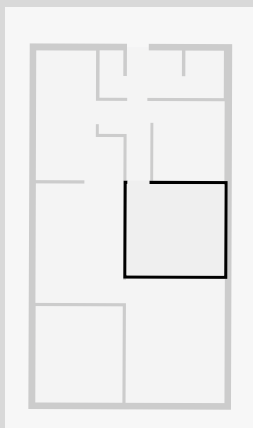

# Unit 2/106 Hyde Street

## Bedroom

Width: 2.72 m  
 Length: 3.04 m  
 Area: 8.23 m<sup>2</sup>  
 Perimeter: 11.50 m

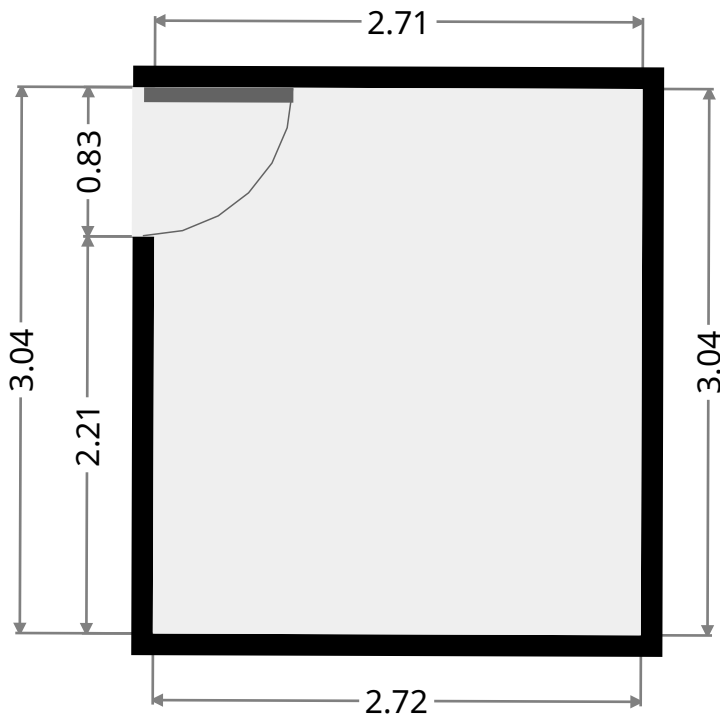
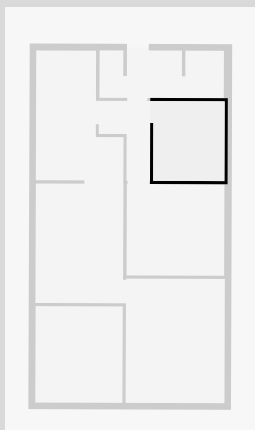

## Laundry Room

Width: 1.81 m  
 Length: 2.09 m  
 Area: 3.79 m<sup>2</sup>  
 Perimeter: 7.81 m

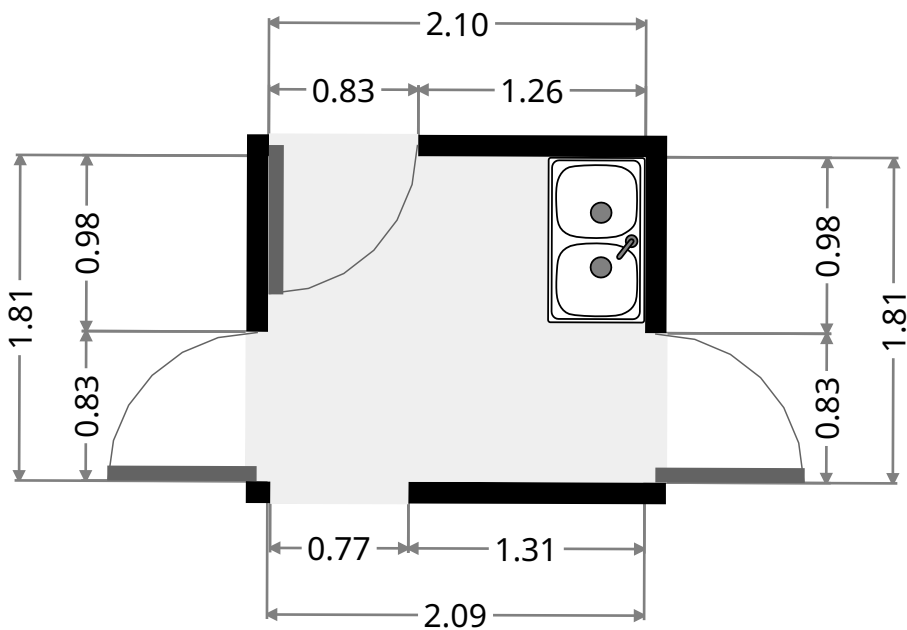
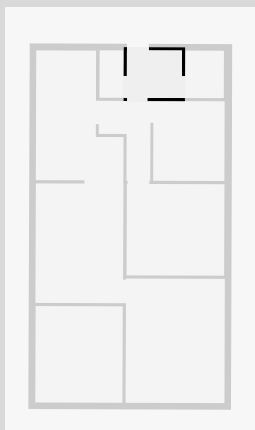

THIS FLOORPLAN IS PROVIDED WITHOUT WARRANTY OF ANY KIND. SENSOPIA DISCLAIMS ANY WARRANTY INCLUDING, WITHOUT LIMITATION, SATISFACTORY QUALITY OR ACCURACY OF DIMENSIONS.

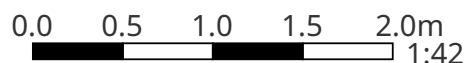

# Unit 2/106 Hyde Street

## Bathroom

Width: 1.46 m  
Length: 1.81 m  
Area: 2.65 m<sup>2</sup>  
Perimeter: 6.54 m

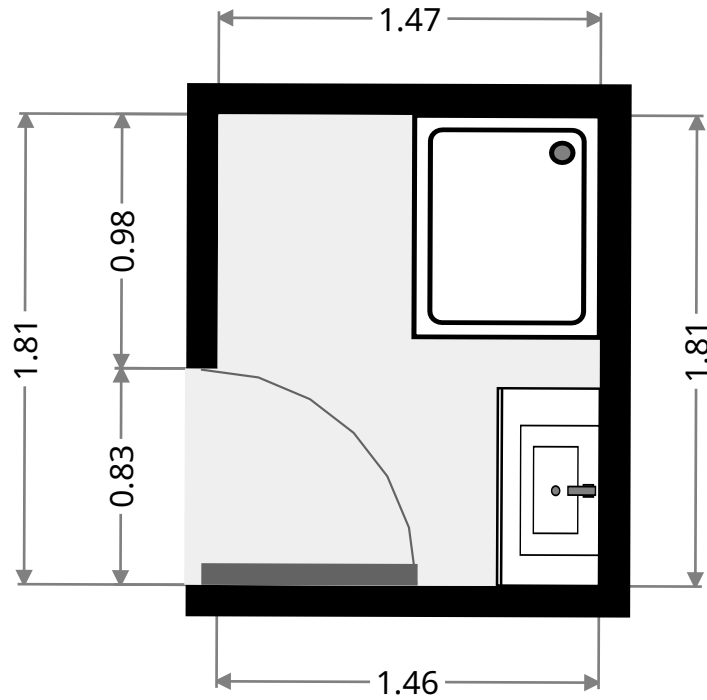
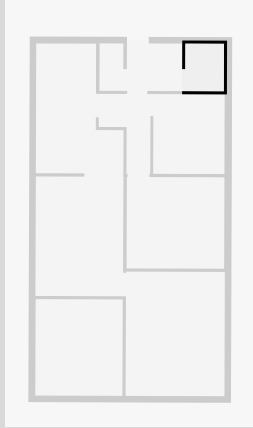

## Toilet

Width: 0.90 m  
Length: 1.80 m  
Area: 1.63 m<sup>2</sup>  
Perimeter: 5.42 m

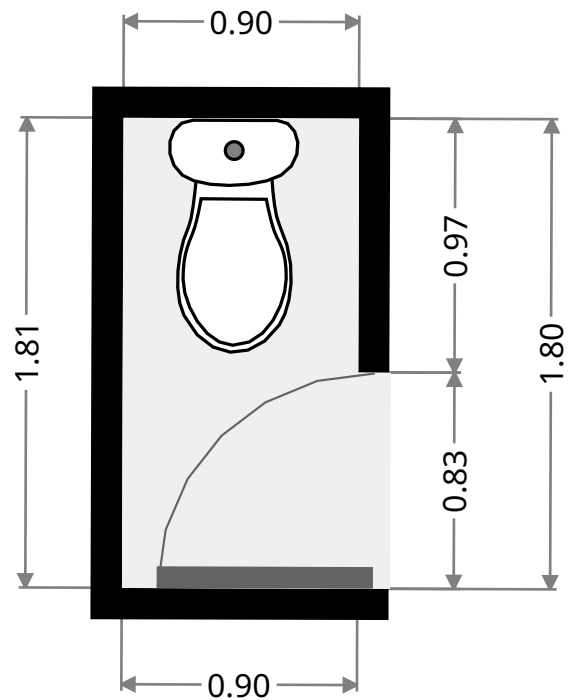
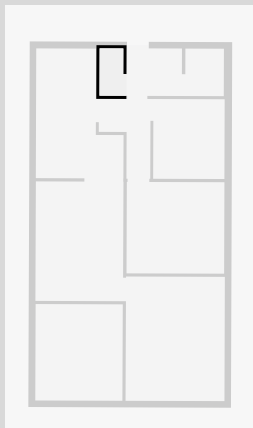

# Unit 2/106 Hyde Street

## Carport

Width: 3.77 m  
Length: 4.73 m  
Area: 17.81 m<sup>2</sup>  
Perimeter: 16.99 m

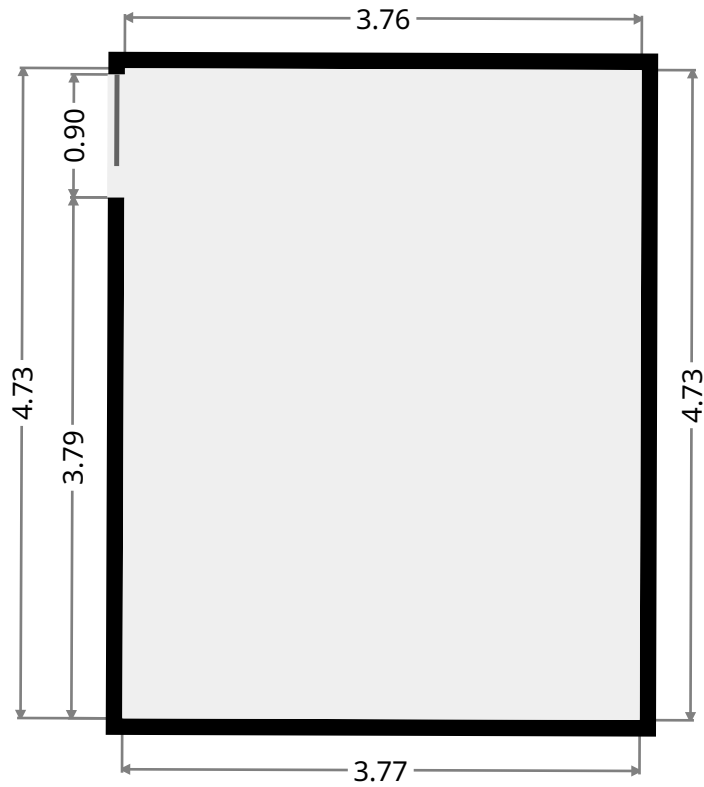
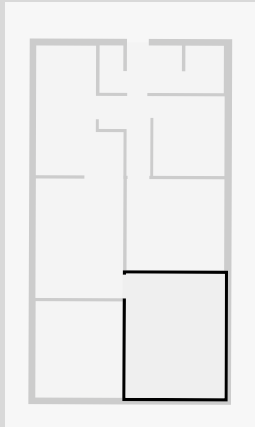

## Outdoor Area

Width: 3.32 m  
Length: 3.67 m  
Area: 12.17 m<sup>2</sup>  
Perimeter: 13.97 m

