

# Unit 1/89 Marie Street

## Ground Floor

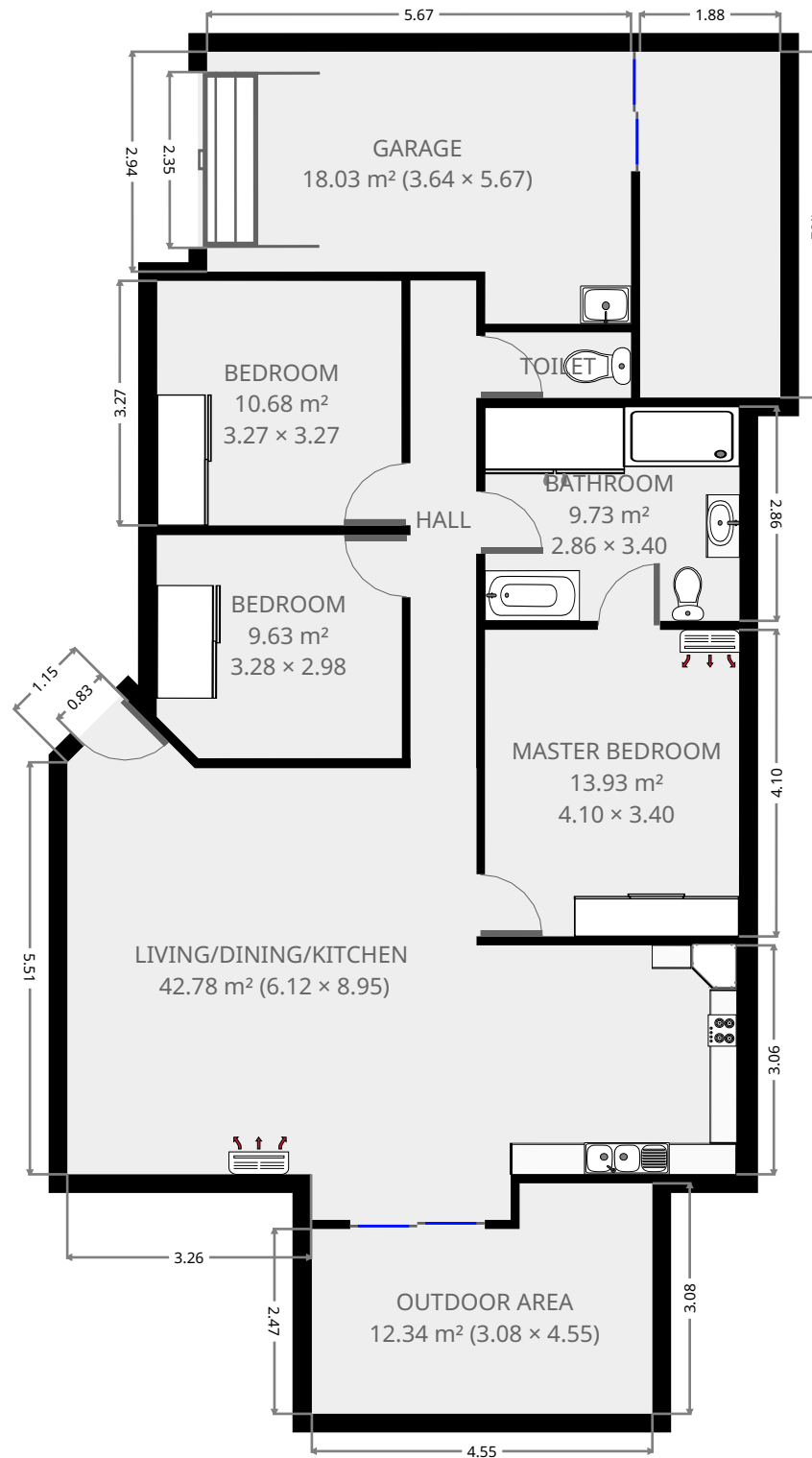

THIS FLOORPLAN IS PROVIDED WITHOUT WARRANTY OF ANY KIND. SENSOPIA DISCLAIMS ANY WARRANTY INCLUDING, WITHOUT LIMITATION, SATISFACTORY QUALITY OR ACCURACY OF DIMENSIONS.

# Unit 1/89 Marie Street

## Living/Dining/Kitchen

Width: 6.12 m  
 Length: 8.95 m  
 Area: 42.78 m<sup>2</sup>  
 Perimeter: 30.76 m  
 Ceiling Height: 2.17 m

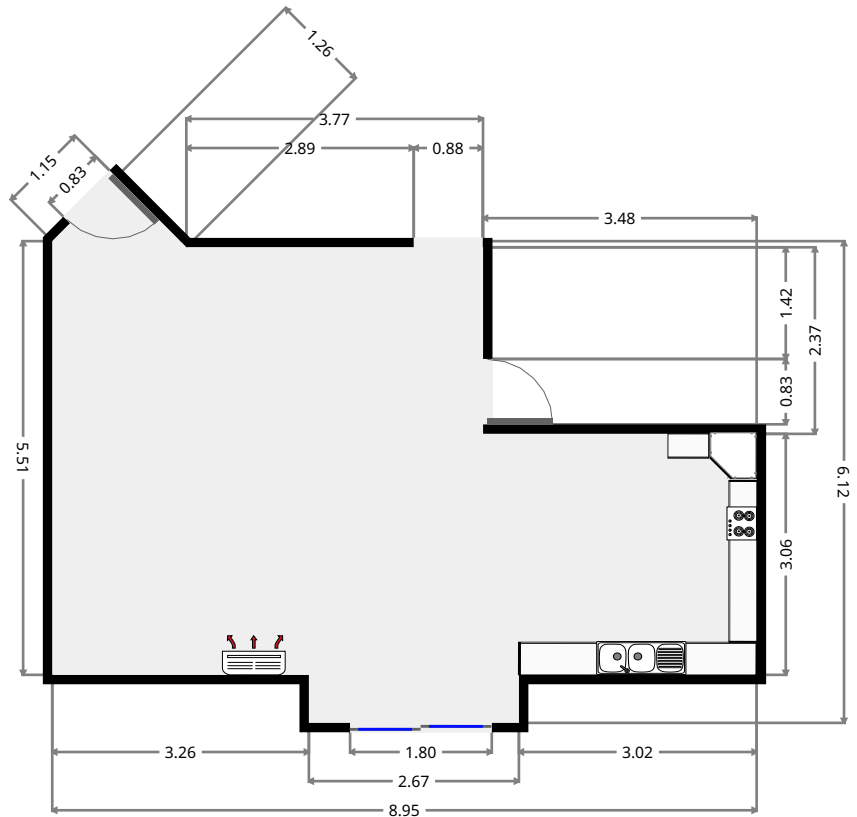
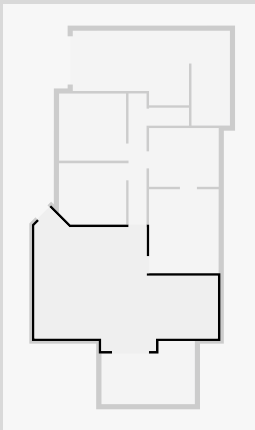

## Master Bedroom

Width: 3.40 m  
 Length: 4.10 m  
 Area: 13.93 m<sup>2</sup>  
 Perimeter: 14.99 m

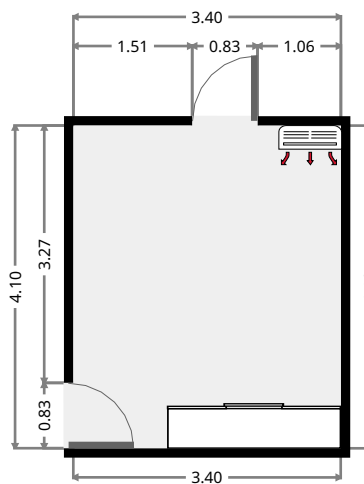
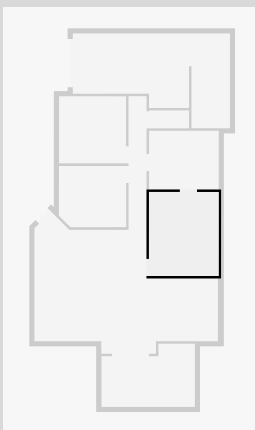

THIS FLOORPLAN IS PROVIDED WITHOUT WARRANTY OF ANY KIND. SENSOPIA DISCLAIMS ANY WARRANTY INCLUDING, WITHOUT LIMITATION, SATISFACTORY QUALITY OR ACCURACY OF DIMENSIONS.

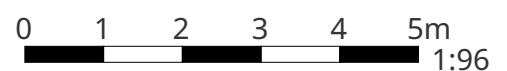

# Unit 1/89 Marie Street

## Hall

Width: 0.88 m  
 Length: 6.39 m  
 Area: 5.62 m<sup>2</sup>  
 Perimeter: 14.55 m

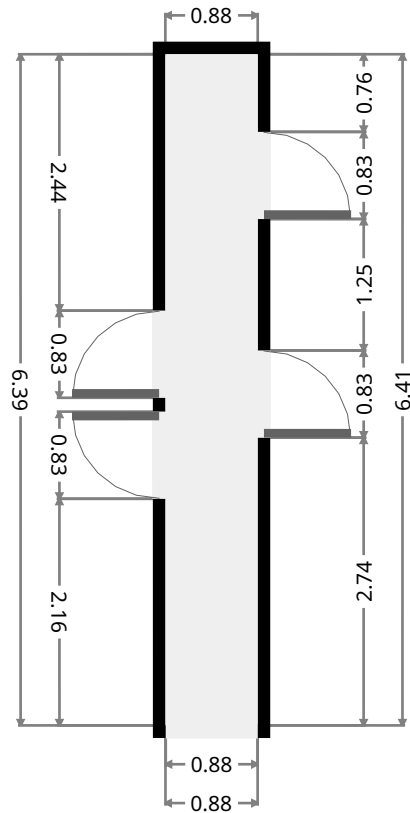
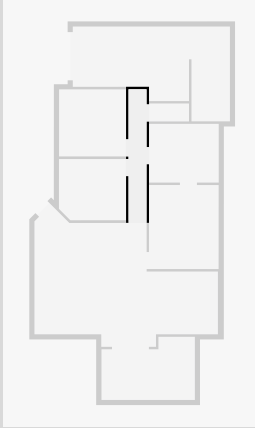

## Bedroom

Width: 2.98 m  
 Length: 3.28 m  
 Area: 9.63 m<sup>2</sup>  
 Perimeter: 12.20 m

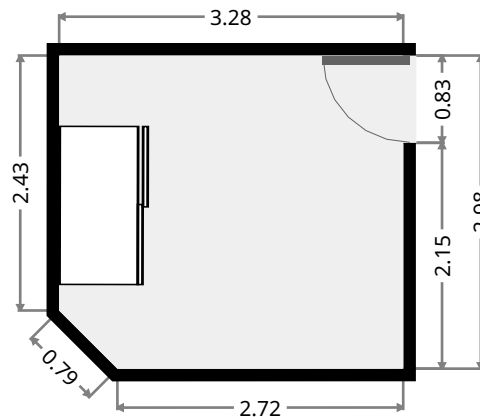
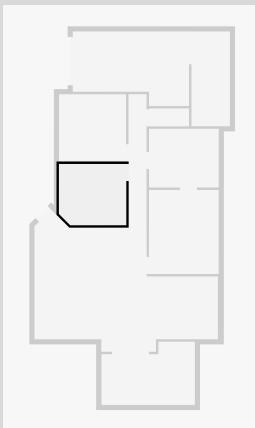

# Unit 1/89 Marie Street

## Bedroom

Width: 3.27 m  
Length: 3.27 m  
Area: 10.68 m<sup>2</sup>  
Perimeter: 13.07 m

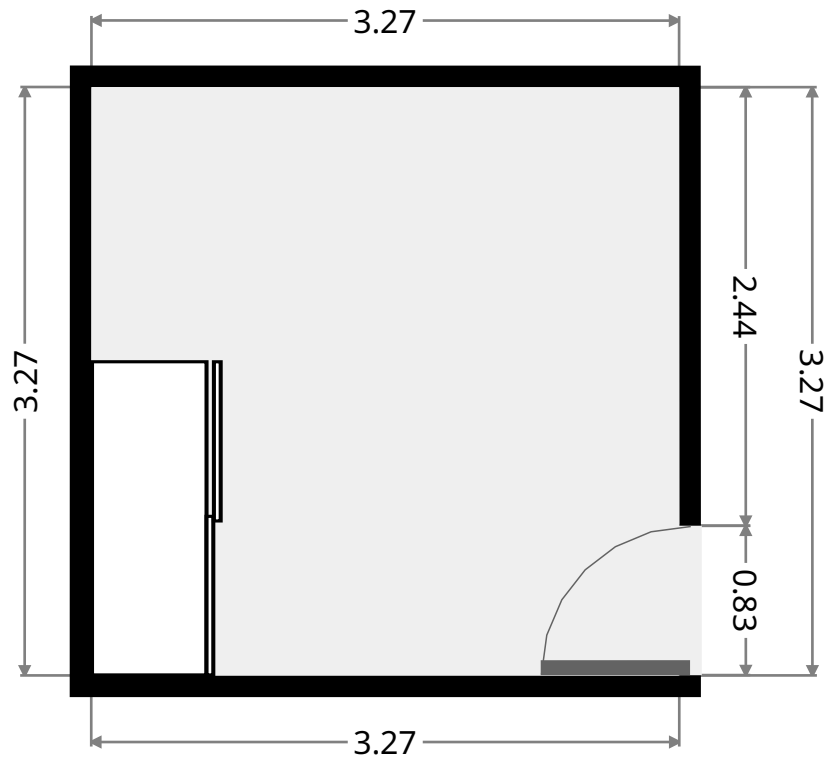
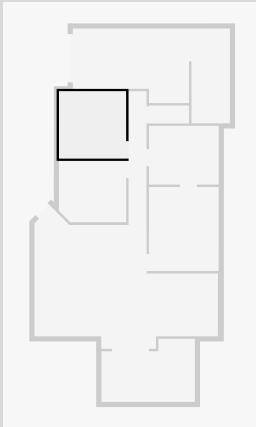

## Toilet

Width: 0.88 m  
Length: 1.95 m  
Area: 1.71 m<sup>2</sup>  
Perimeter: 5.65 m

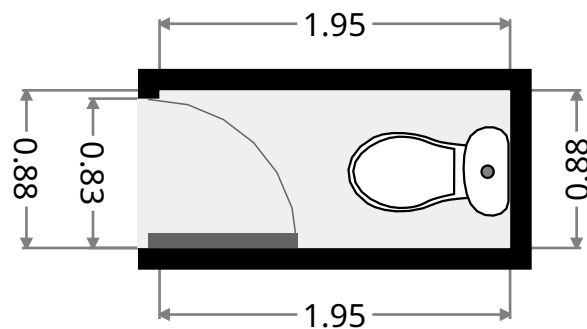
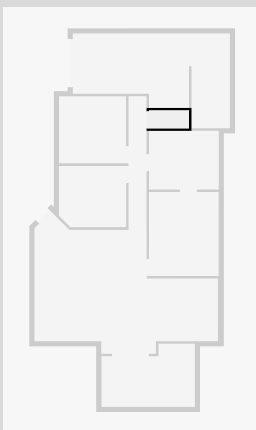

# Unit 1/89 Marie Street

## Garage

Width: 3.64 m  
 Length: 5.67 m  
 Area: 18.03 m<sup>2</sup>  
 Perimeter: 18.61 m

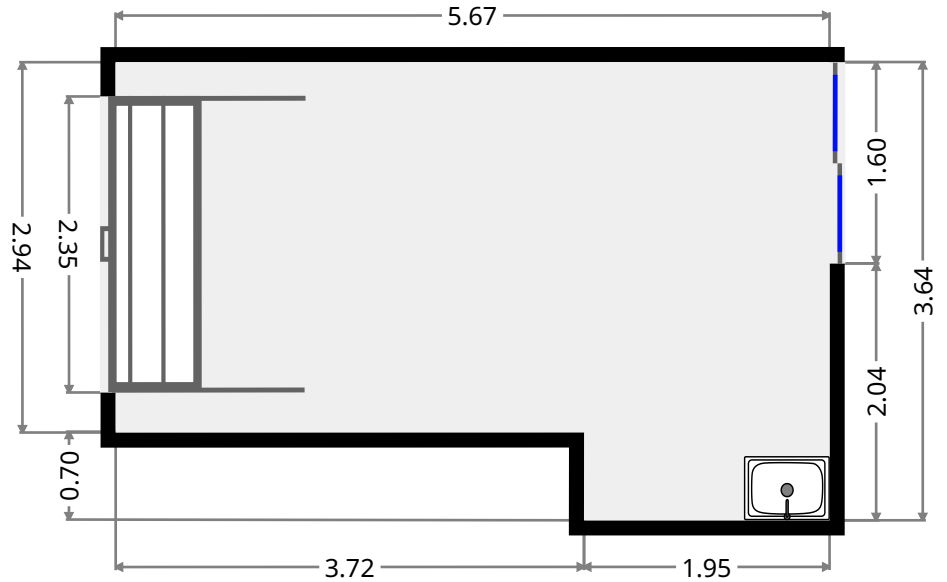
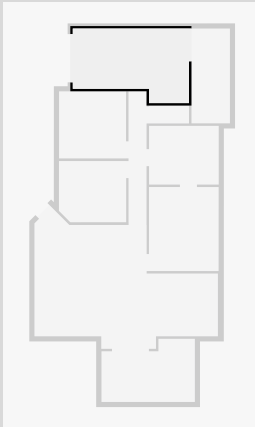

## Bathroom

Width: 2.86 m  
 Length: 3.40 m  
 Area: 9.73 m<sup>2</sup>  
 Perimeter: 12.52 m

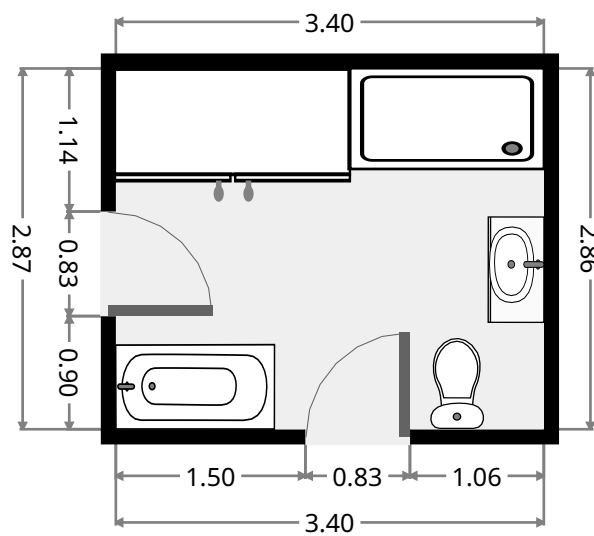
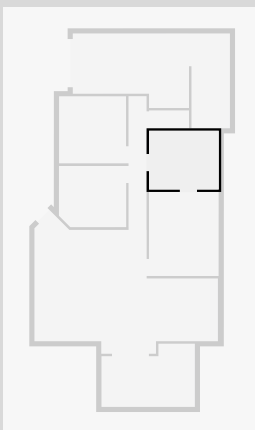

THIS FLOORPLAN IS PROVIDED WITHOUT WARRANTY OF ANY KIND. SENSOPIA DISCLAIMS ANY WARRANTY INCLUDING, WITHOUT LIMITATION, SATISFACTORY QUALITY OR ACCURACY OF DIMENSIONS.

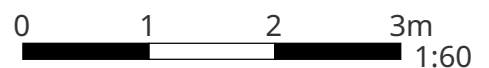

# Unit 1/89 Marie Street

## Clothes line Area

Width: 1.87 m  
 Length: 4.62 m  
 Area: 8.67 m<sup>2</sup>  
 Perimeter: 13.00 m

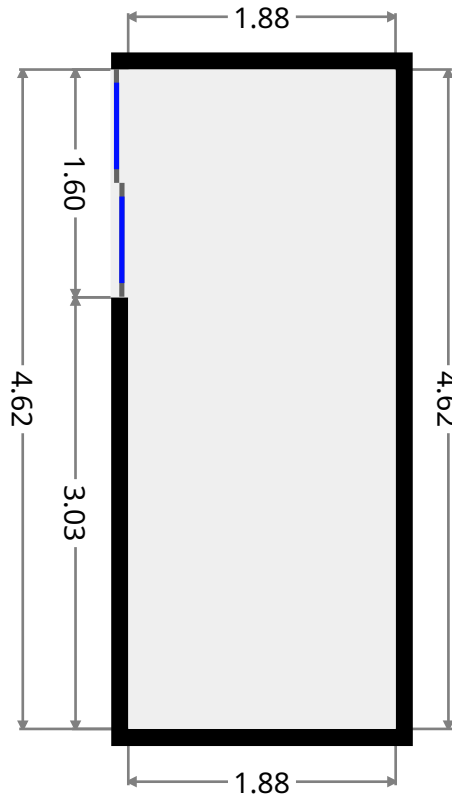
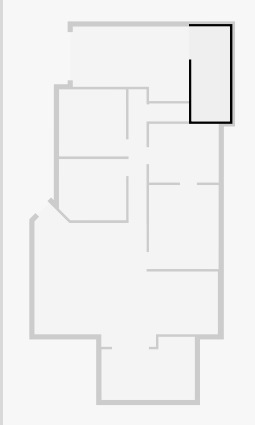

## Outdoor Area

Width: 3.08 m  
 Length: 4.55 m  
 Area: 12.34 m<sup>2</sup>  
 Perimeter: 15.27 m

