

86 Springfield Drive

Ground Floor

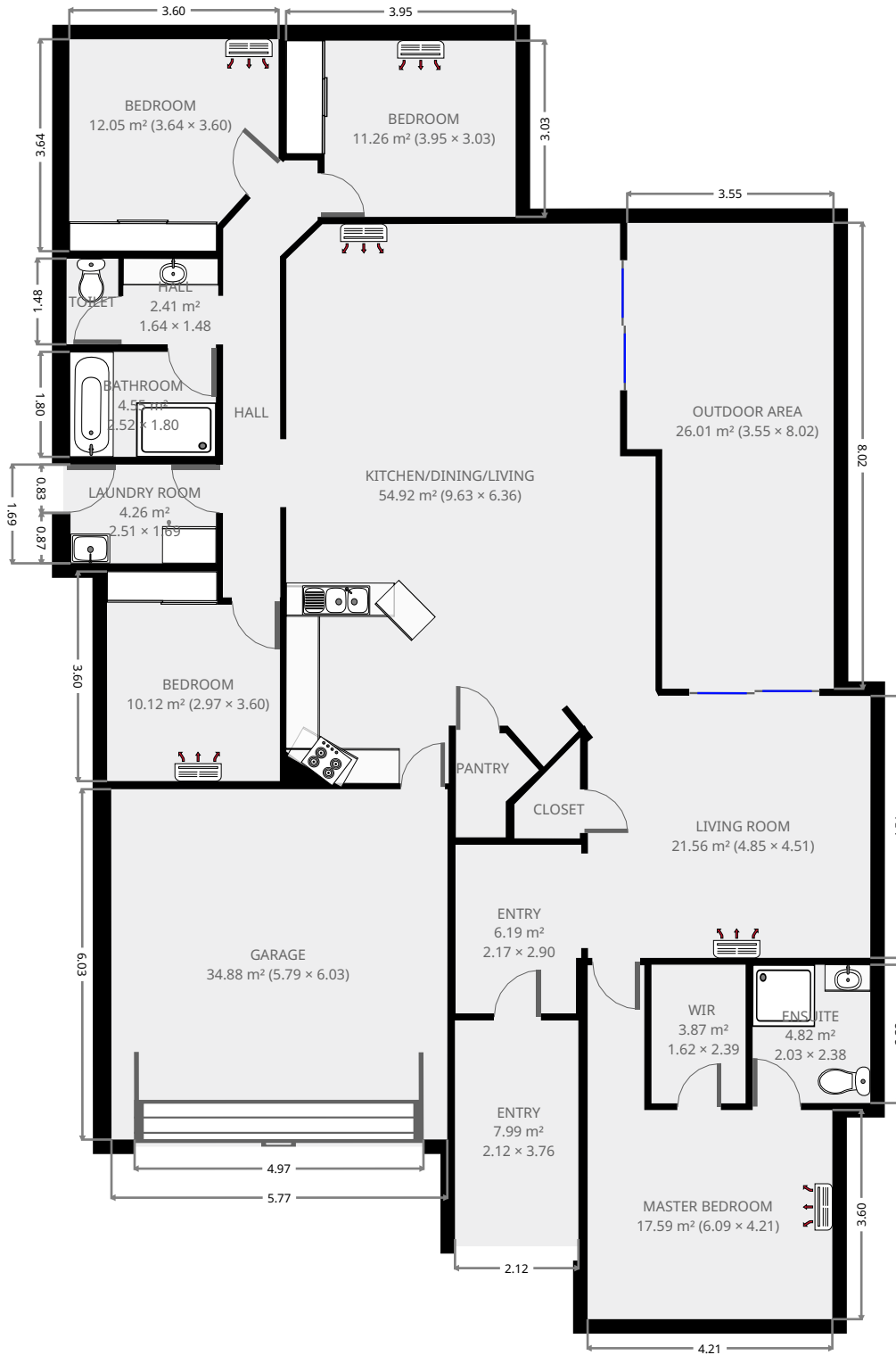

THIS FLOORPLAN IS PROVIDED WITHOUT WARRANTY OF ANY KIND. SENSOPIA DISCLAIMS ANY WARRANTY INCLUDING, WITHOUT LIMITATION, SATISFACTORY QUALITY OR ACCURACY OF DIMENSIONS.



86 Springfield Drive

Bedroom

Width: 2.97 m
Length: 3.60 m
Area: 10.12 m²
Perimeter: 13.17 m

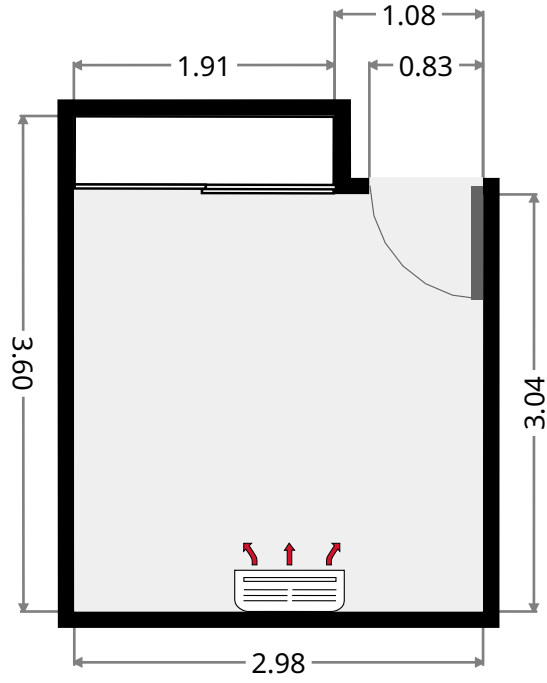
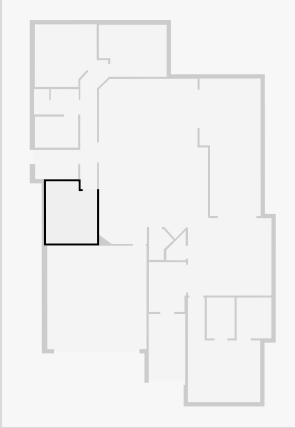

Entry

Width: 2.12 m
Length: 3.76 m
Area: 7.99 m²
Perimeter: 11.77 m

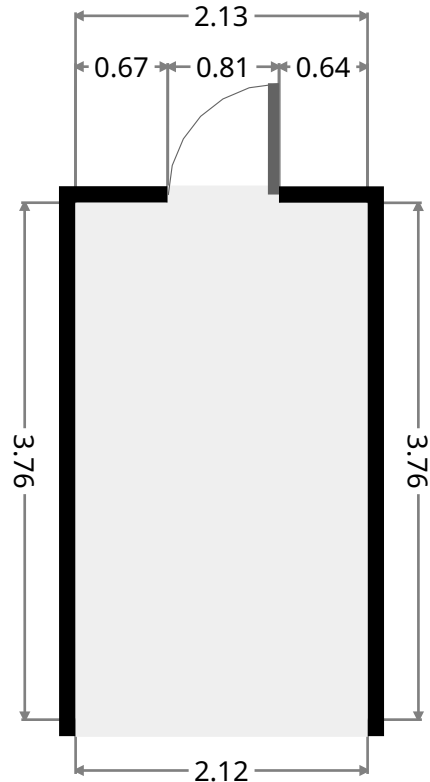
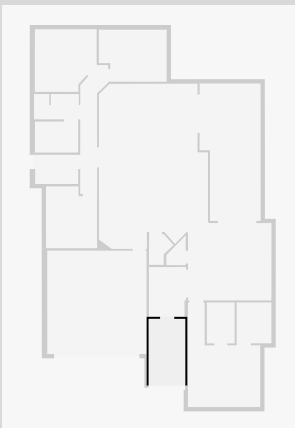

86 Springfield Drive

Outdoor Area

Width: 3.55 m
 Length: 8.02 m
 Area: 26.01 m²
 Perimeter: 23.14 m

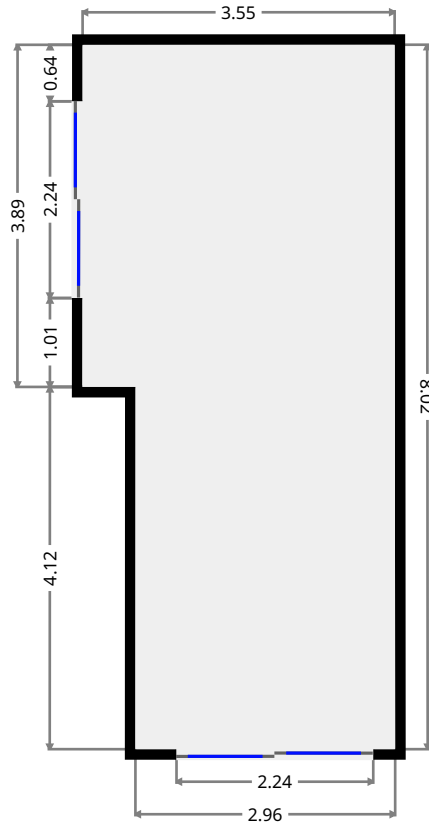
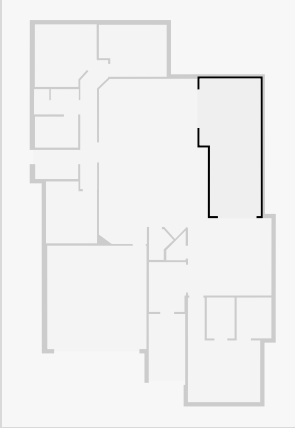

Garage

Width: 5.79 m
 Length: 6.03 m
 Area: 34.88 m²
 Perimeter: 23.63 m

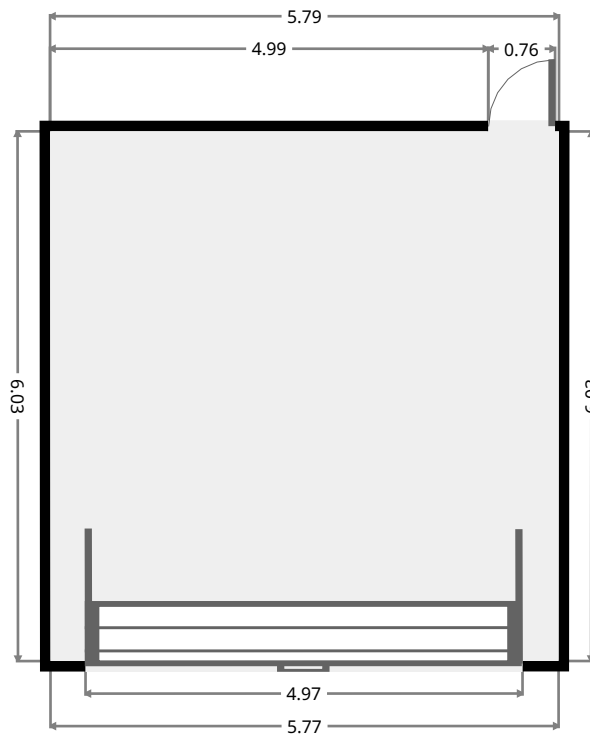
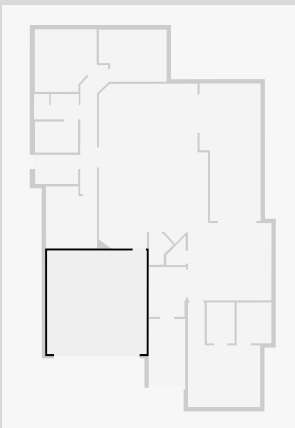

THIS FLOORPLAN IS PROVIDED WITHOUT WARRANTY OF ANY KIND. SENSOPIA DISCLAIMS ANY WARRANTY INCLUDING, WITHOUT LIMITATION, SATISFACTORY QUALITY OR ACCURACY OF DIMENSIONS.

86 Springfield Drive

Bedroom

Width: 3.03 m
 Length: 3.95 m
 Area: 11.26 m²
 Perimeter: 13.97 m

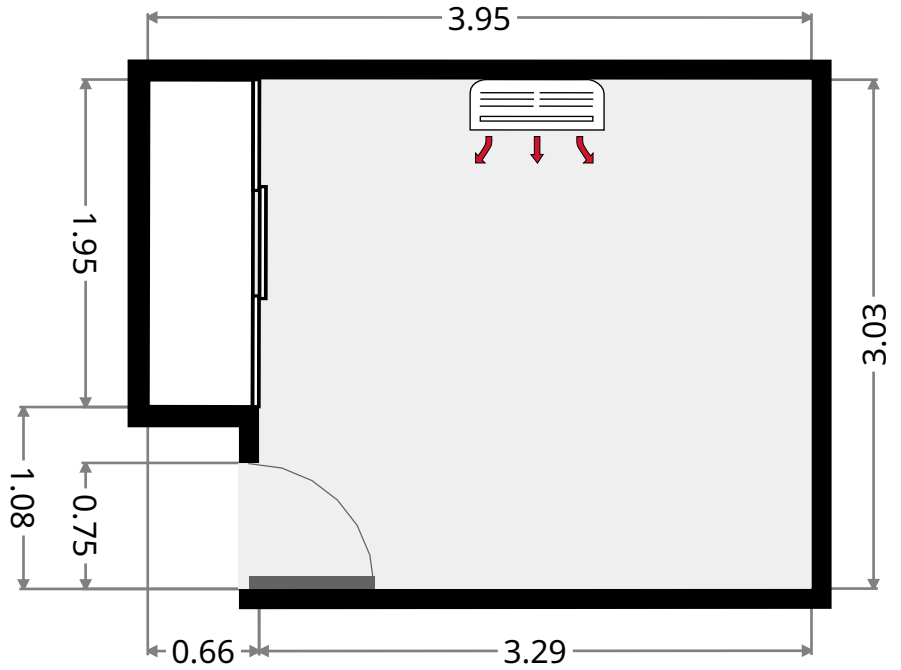
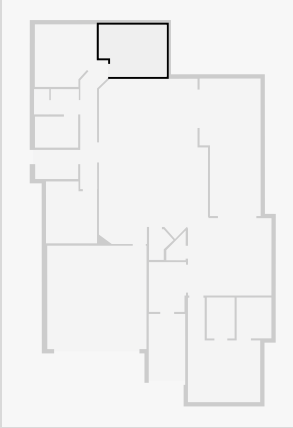

Bedroom

Width: 3.60 m
 Length: 3.64 m
 Area: 12.05 m²
 Perimeter: 13.85 m

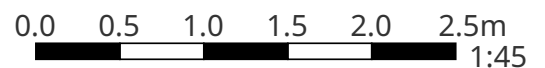
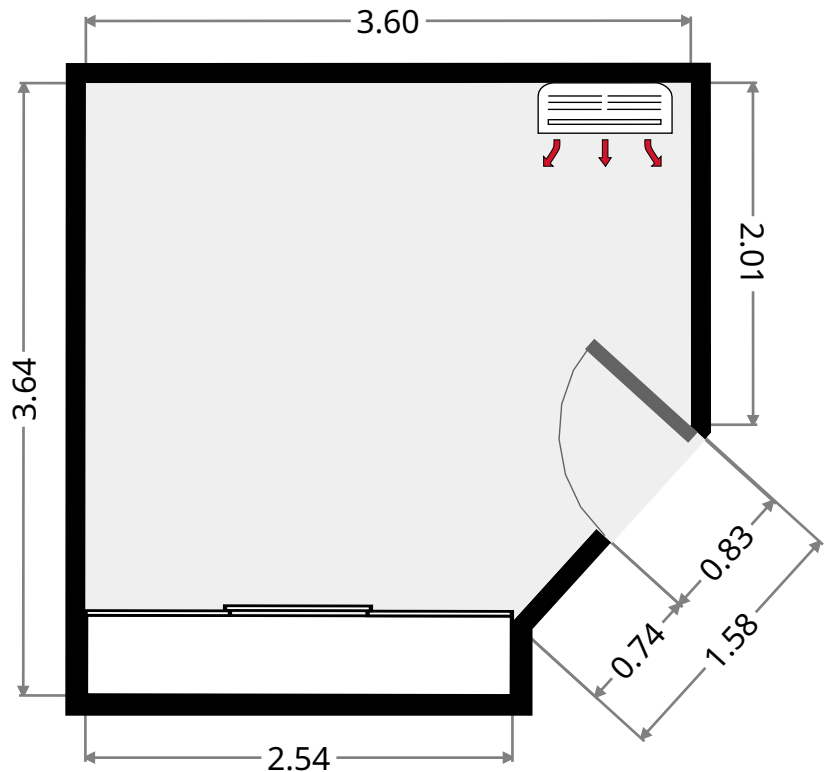
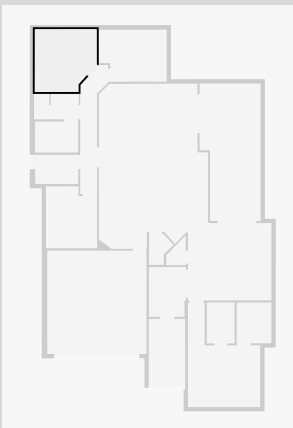

THIS FLOORPLAN IS PROVIDED WITHOUT WARRANTY OF ANY KIND. SENSOPIA DISCLAIMS ANY WARRANTY INCLUDING, WITHOUT LIMITATION, SATISFACTORY QUALITY OR ACCURACY OF DIMENSIONS.

86 Springfield Drive

Toilet

Width: 0.89 m
 Length: 1.48 m
 Area: 1.31 m²
 Perimeter: 4.73 m

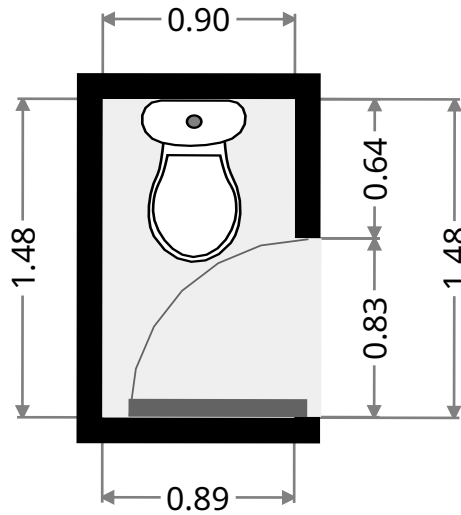
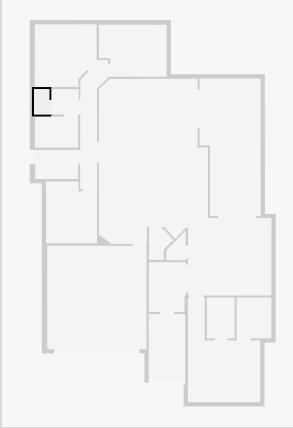

Hall

Width: 1.48 m
 Length: 1.64 m
 Area: 2.41 m²
 Perimeter: 6.22 m

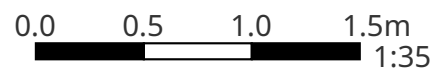
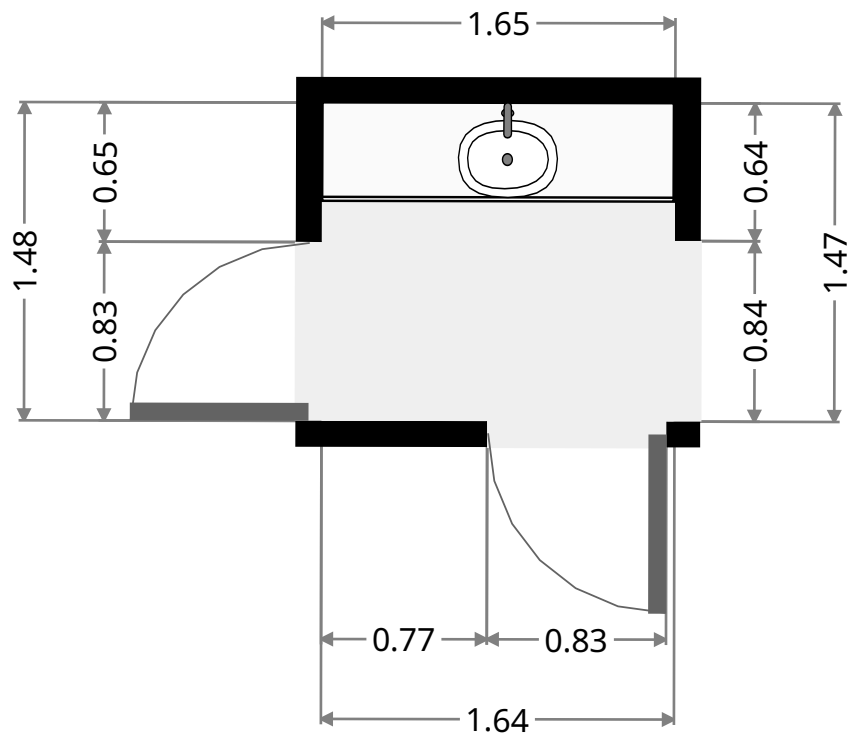
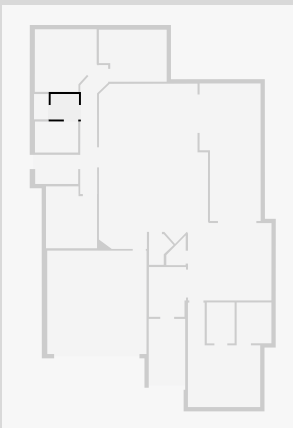

86 Springfield Drive

Bathroom

Width: 1.80 m
 Length: 2.52 m
 Area: 4.55 m²
 Perimeter: 8.65 m

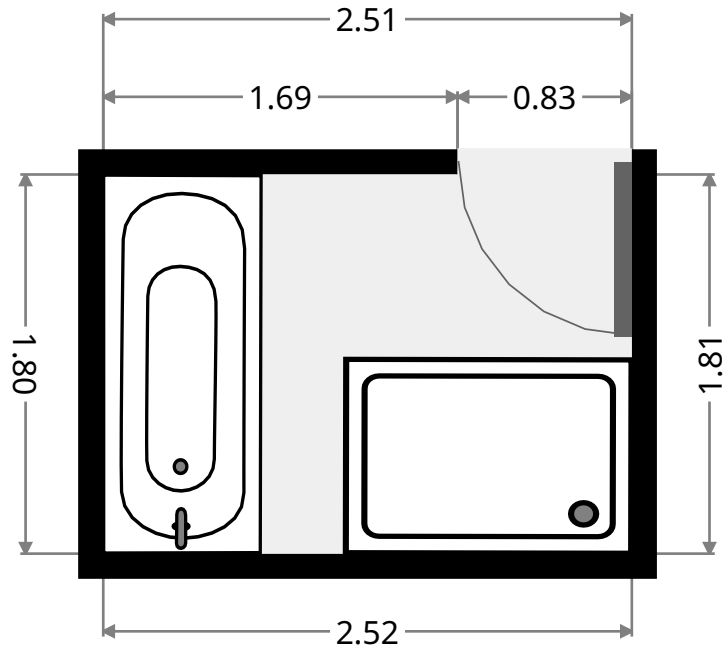
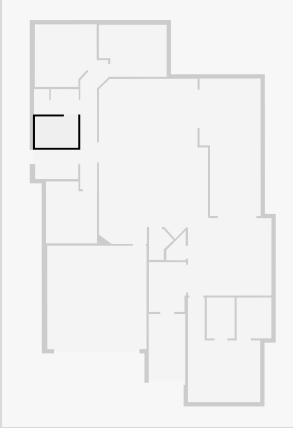

Laundry Room

Width: 1.69 m
 Length: 2.51 m
 Area: 4.26 m²
 Perimeter: 8.41 m

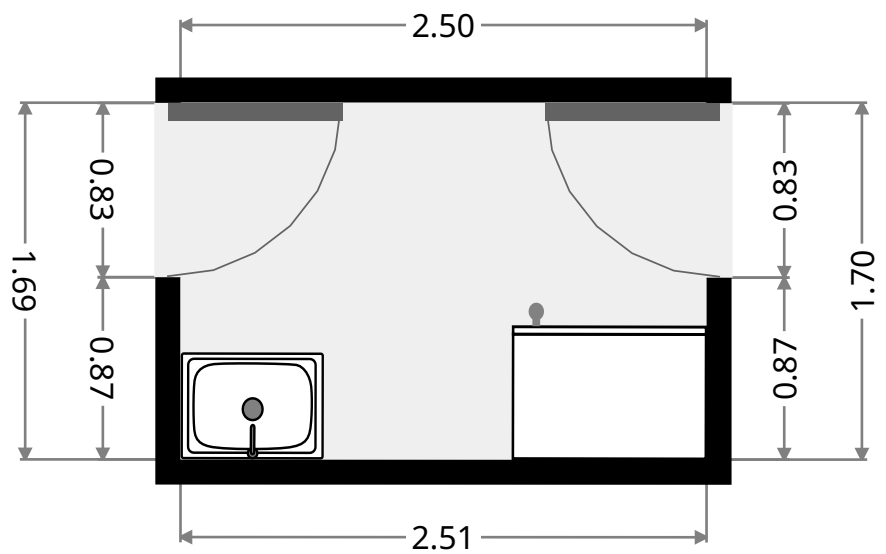
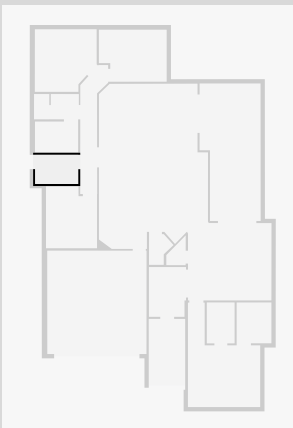

THIS FLOORPLAN IS PROVIDED WITHOUT WARRANTY OF ANY KIND. SENSOPIA DISCLAIMS ANY WARRANTY INCLUDING, WITHOUT LIMITATION, SATISFACTORY QUALITY OR ACCURACY OF DIMENSIONS.

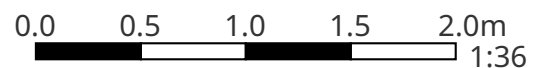

86 Springfield Drive

Entry

Width: 2.17 m
 Length: 2.90 m
 Area: 6.19 m²
 Perimeter: 10.13 m

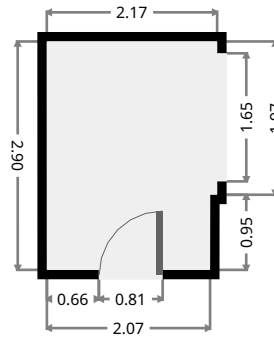
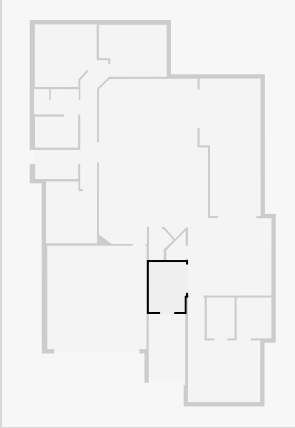

Hall

Width: 1.62 m
 Length: 7.52 m
 Area: 7.63 m²
 Perimeter: 17.28 m

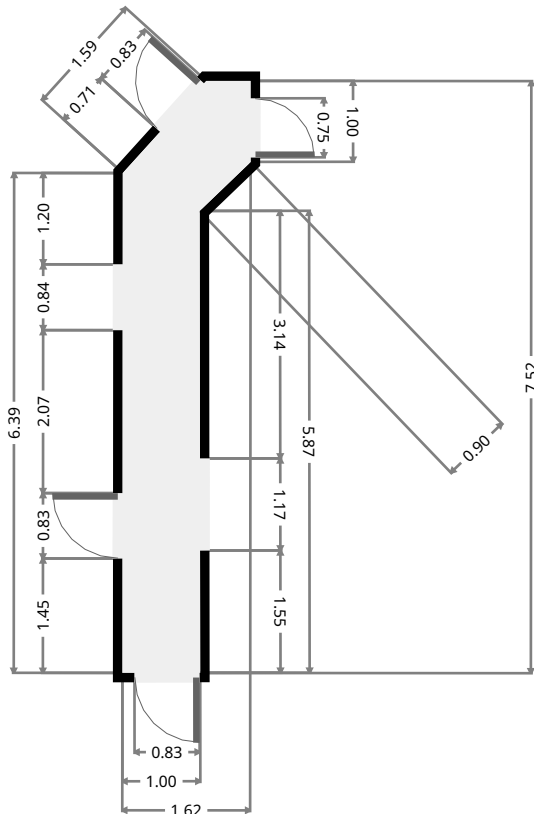
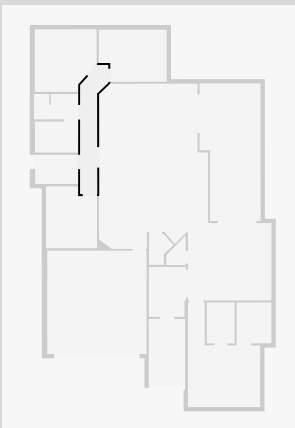

THIS FLOORPLAN IS PROVIDED WITHOUT WARRANTY OF ANY KIND. SENSOPIA DISCLAIMS ANY WARRANTY INCLUDING, WITHOUT LIMITATION, SATISFACTORY QUALITY OR ACCURACY OF DIMENSIONS.

86 Springfield Drive

Pantry

Width: 0.86 m
 Length: 1.80 m
 Area: 1.87 m²
 Perimeter: 5.76 m

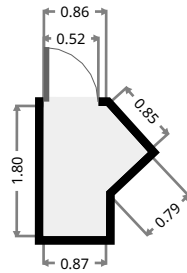
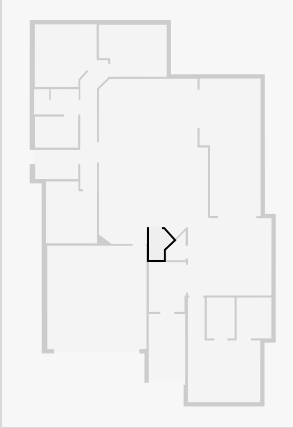

Kitchen/Dining/Living

Width: 6.36 m
 Length: 9.63 m
 Area: 54.92 m²
 Perimeter: 31.40 m

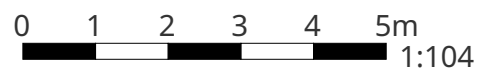
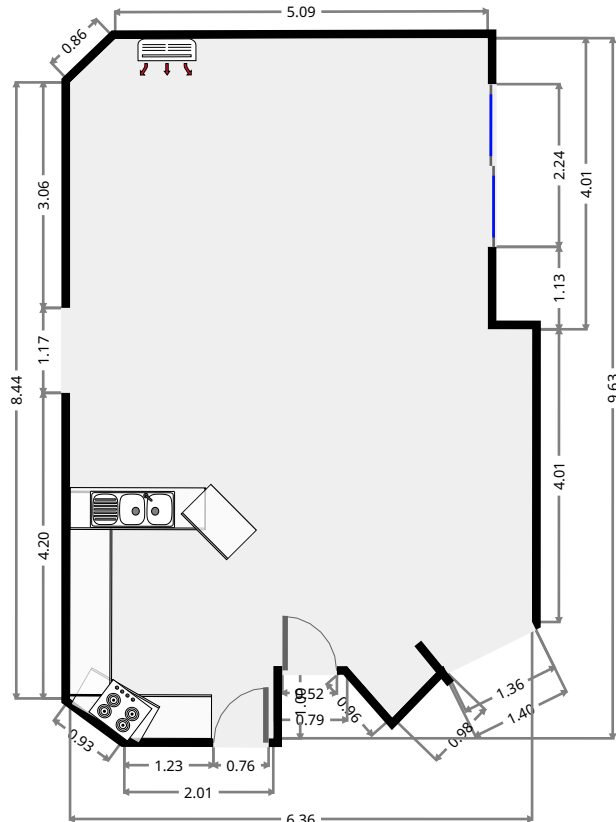
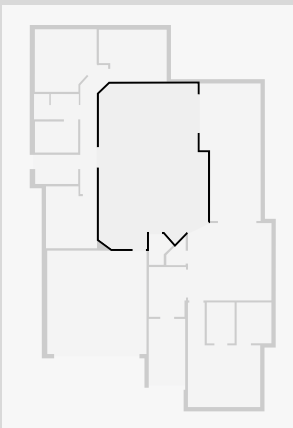

THIS FLOORPLAN IS PROVIDED WITHOUT WARRANTY OF ANY KIND. SENSOPIA DISCLAIMS ANY WARRANTY INCLUDING, WITHOUT LIMITATION, SATISFACTORY QUALITY OR ACCURACY OF DIMENSIONS.

86 Springfield Drive

Closet

Width: 1.12 m
Length: 1.74 m
Area: 1.31 m²
Perimeter: 5.06 m

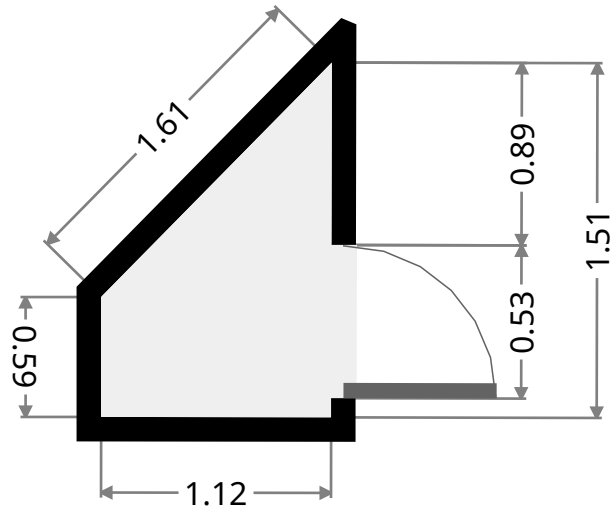
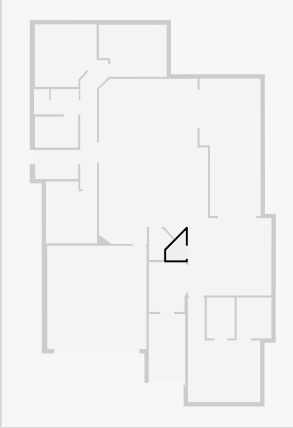

Ensuite

Width: 2.03 m
Length: 2.38 m
Area: 4.82 m²
Perimeter: 8.81 m

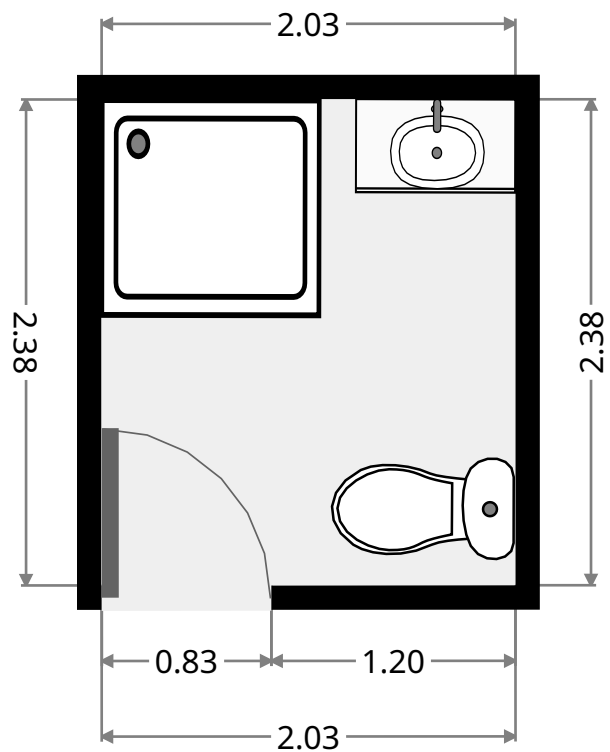
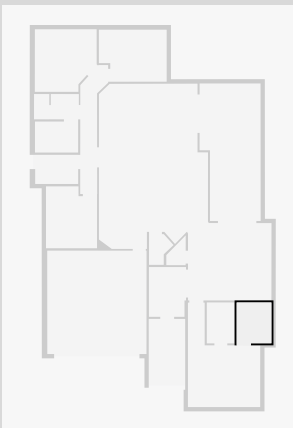

THIS FLOORPLAN IS PROVIDED WITHOUT WARRANTY OF ANY KIND. SENSOPIA DISCLAIMS ANY WARRANTY INCLUDING, WITHOUT LIMITATION, SATISFACTORY QUALITY OR ACCURACY OF DIMENSIONS.

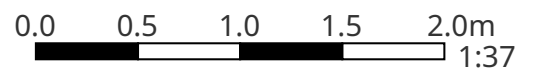

86 Springfield Drive

WIR

Width: 1.62 m
 Length: 2.39 m
 Area: 3.87 m²
 Perimeter: 8.01 m

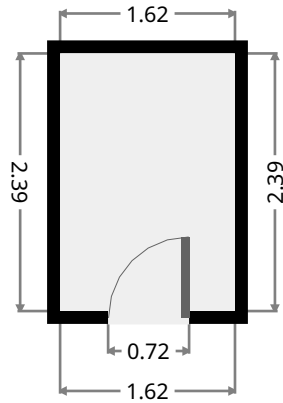
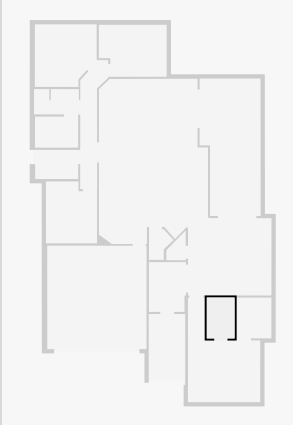

Master Bedroom

Width: 4.21 m
 Length: 6.09 m
 Area: 17.59 m²
 Perimeter: 20.60 m

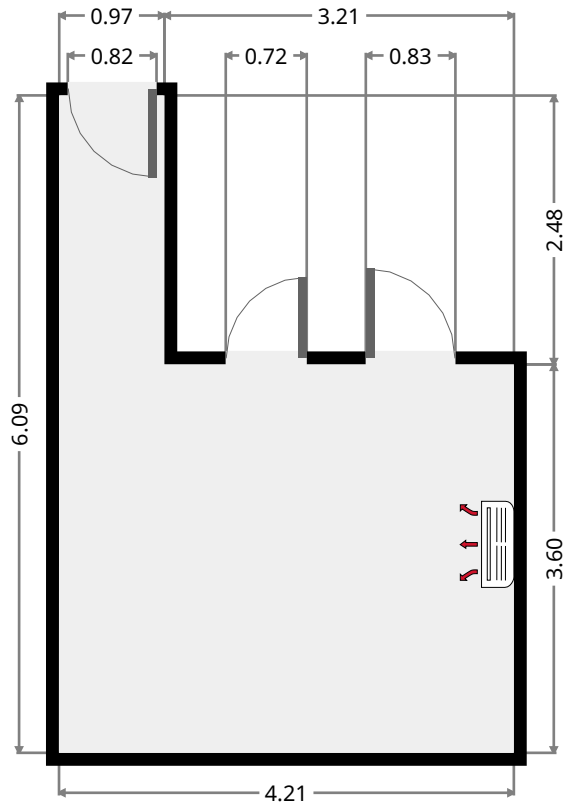
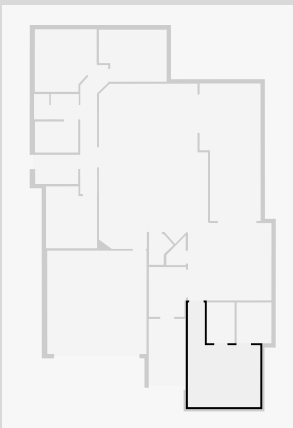

THIS FLOORPLAN IS PROVIDED WITHOUT WARRANTY OF ANY KIND. SENSOPIA DISCLAIMS ANY WARRANTY INCLUDING, WITHOUT LIMITATION, SATISFACTORY QUALITY OR ACCURACY OF DIMENSIONS.

86 Springfield Drive

Living Room

Width: 4.51 m
Length: 4.85 m
Area: 21.56 m²
Perimeter: 18.28 m

