

# 8 Samuel Crescent

## Ground Floor

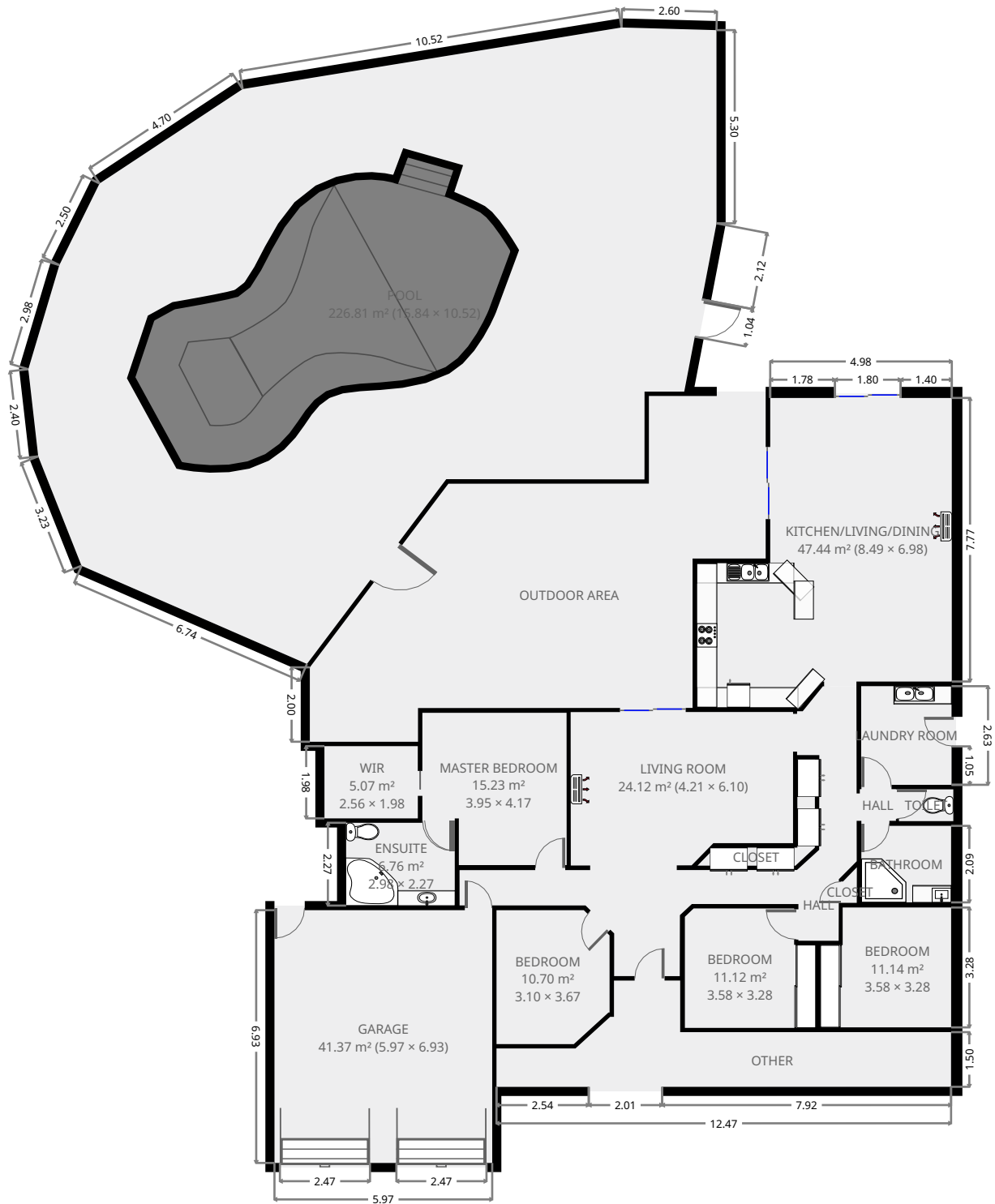

THIS FLOORPLAN IS PROVIDED WITHOUT WARRANTY OF ANY KIND. SENSOPIA DISCLAIMS ANY WARRANTY INCLUDING, WITHOUT LIMITATION, SATISFACTORY QUALITY OR ACCURACY OF DIMENSIONS.



# 8 Samuel Crescent

## Bedroom

Width: 3.28 m  
Length: 3.58 m  
Area: 11.14 m<sup>2</sup>  
Perimeter: 13.73 m

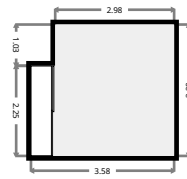
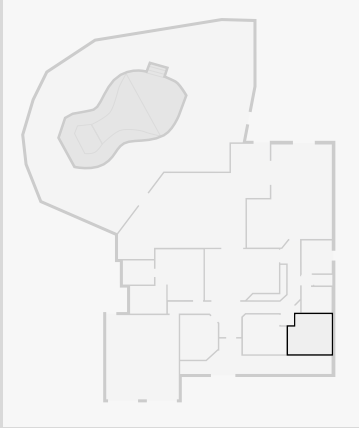

## Pool

Width: 10.52 m  
Length: 15.84 m  
Area: 226.81 m<sup>2</sup>  
Perimeter: 60.94 m

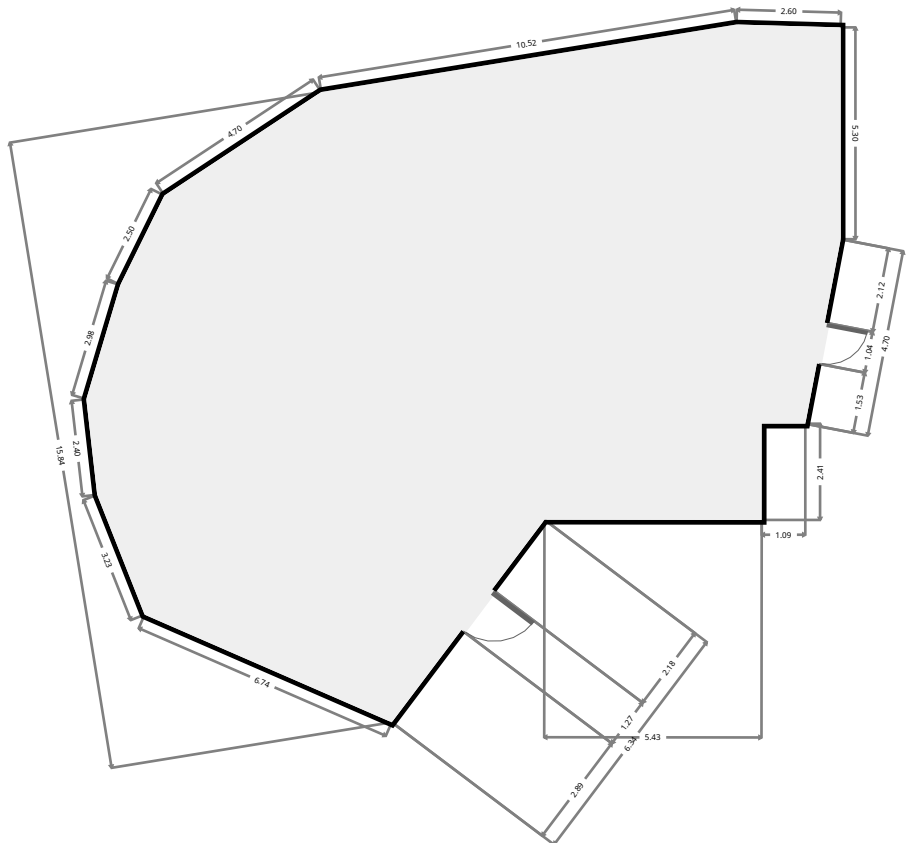
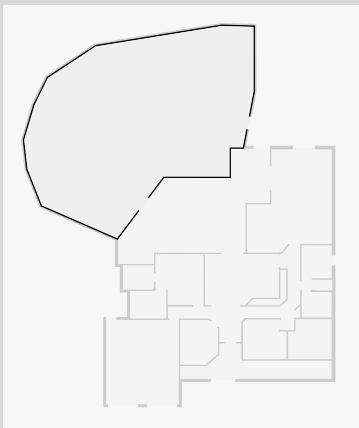

THIS FLOORPLAN IS PROVIDED WITHOUT WARRANTY OF ANY KIND. SENSOPIA DISCLAIMS ANY WARRANTY INCLUDING, WITHOUT LIMITATION, SATISFACTORY QUALITY OR ACCURACY OF DIMENSIONS.

# 8 Samuel Crescent

## Other

Width: 2.91 m  
Length: 12.46 m  
Area: 20.31 m<sup>2</sup>  
Perimeter: 30.22 m

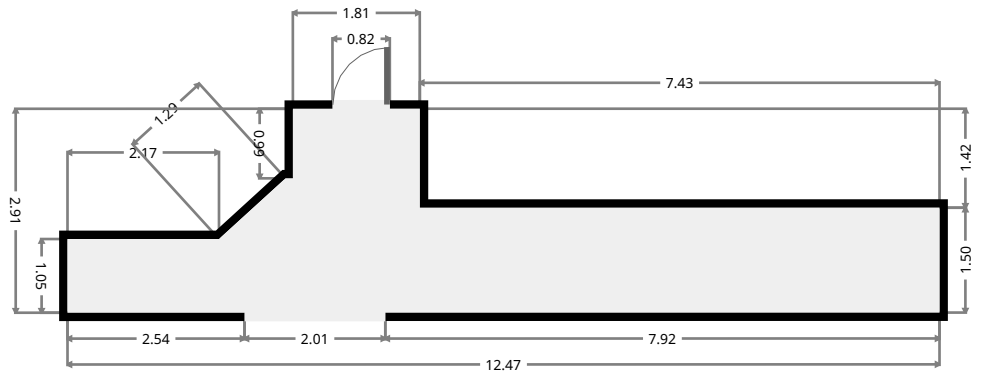
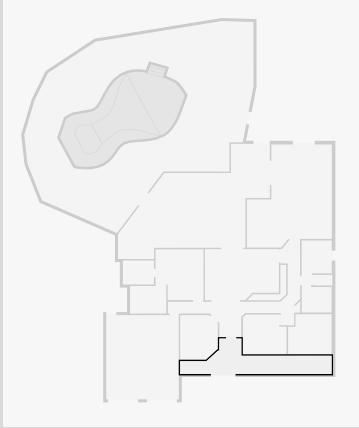

# 8 Samuel Crescent

## Outdoor Area

Width: 9.48 m  
Length: 12.50 m  
Area: 69.51 m<sup>2</sup>  
Perimeter: 41.42 m

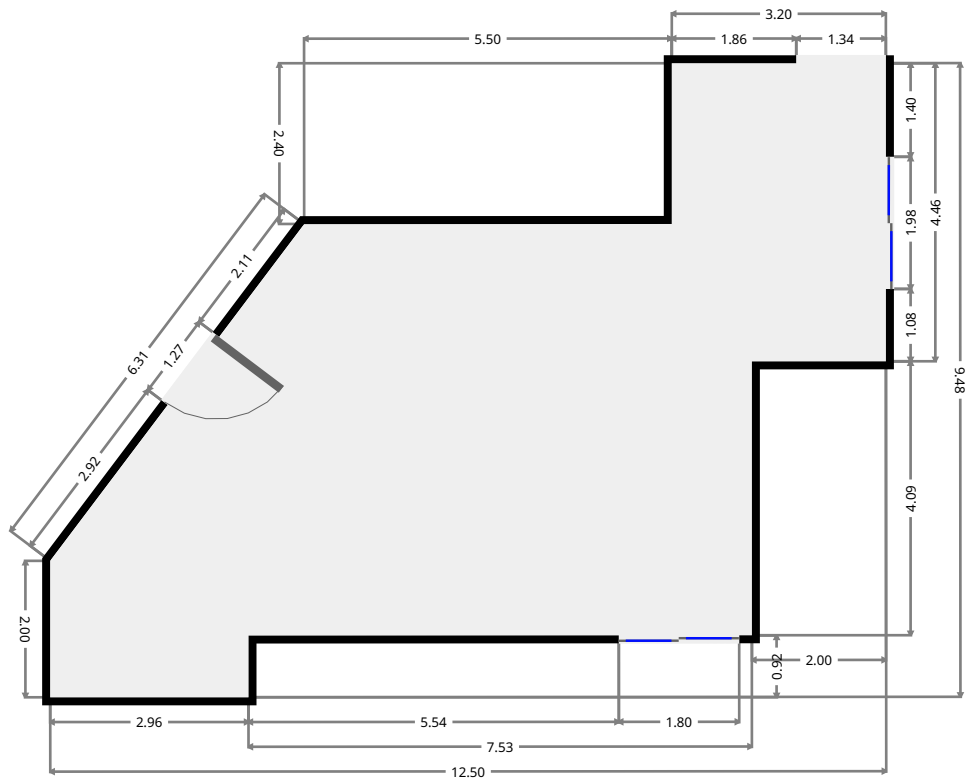
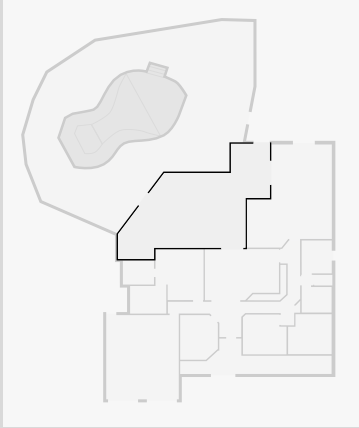

THIS FLOORPLAN IS PROVIDED WITHOUT WARRANTY OF ANY KIND. SENSOPIA DISCLAIMS ANY WARRANTY INCLUDING, WITHOUT LIMITATION, SATISFACTORY QUALITY OR ACCURACY OF DIMENSIONS.



# 8 Samuel Crescent

## Kitchen/Living/Dining

Width: 6.98 m  
 Length: 8.49 m  
 Area: 47.44 m<sup>2</sup>  
 Perimeter: 30.57 m

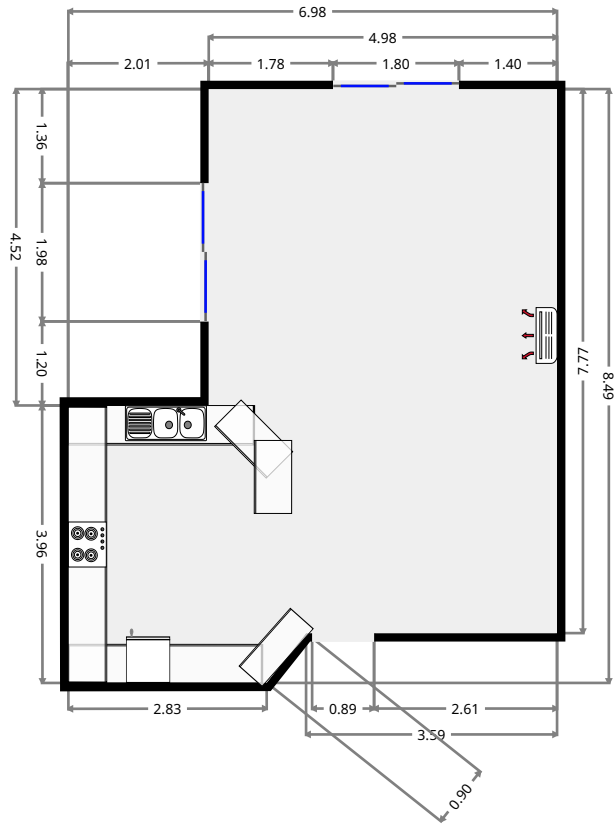
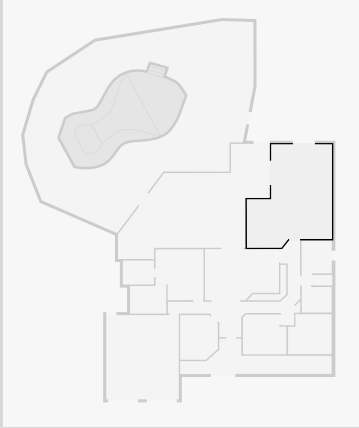

## Closet

Width: 0.38 m  
 Length: 0.98 m  
 Area: 0.29 m<sup>2</sup>  
 Perimeter: 2.48 m

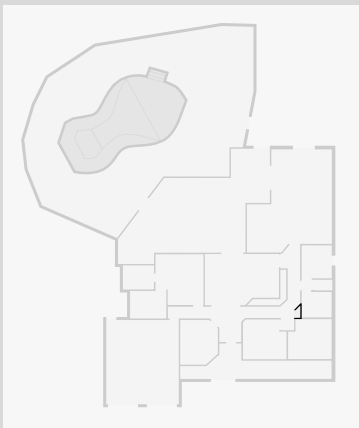

# 8 Samuel Crescent

## Bathroom

Width: 2.09 m  
Length: 2.46 m  
Area: 5.16 m<sup>2</sup>  
Perimeter: 9.12 m

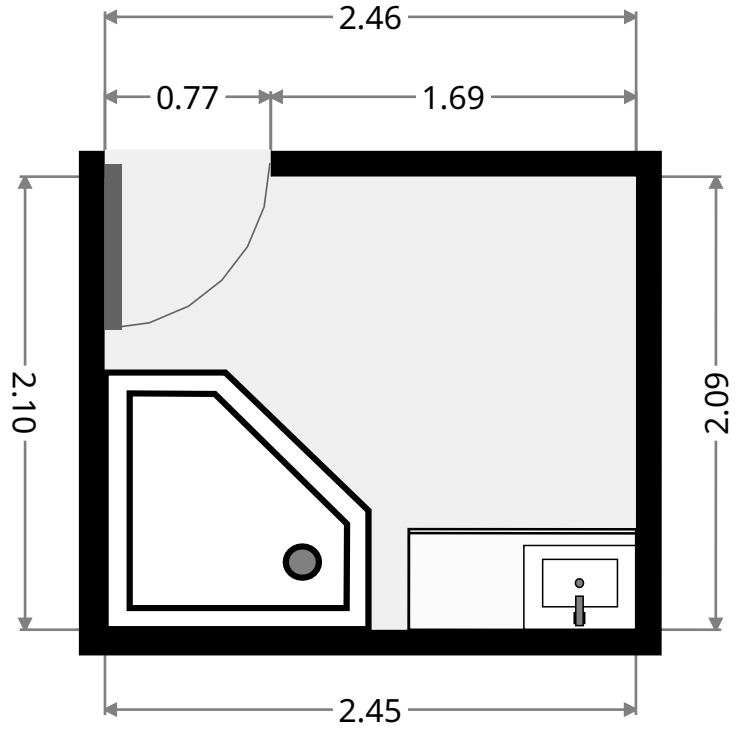
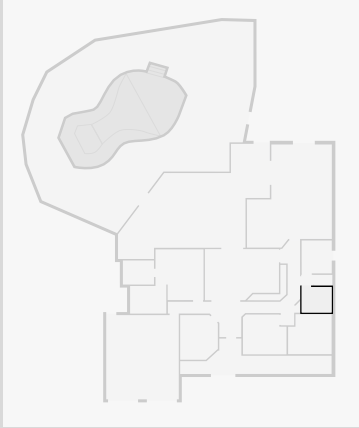

## Toilet

Width: 0.87 m  
Length: 1.49 m  
Area: 1.30 m<sup>2</sup>  
Perimeter: 4.72 m

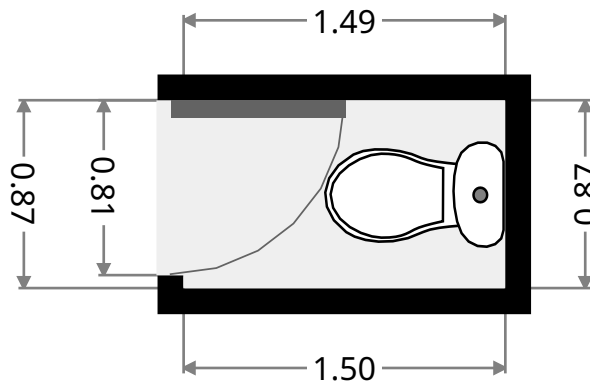
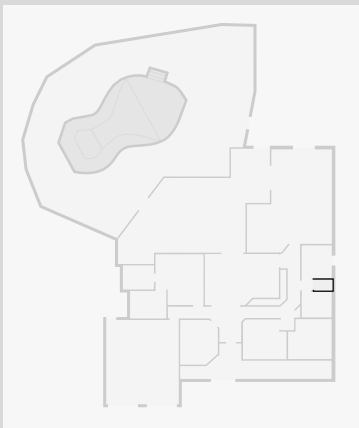

# 8 Samuel Crescent

## Laundry Room

Width: 2.48 m  
 Length: 2.70 m  
 Area: 6.70 m<sup>2</sup>  
 Perimeter: 10.36 m

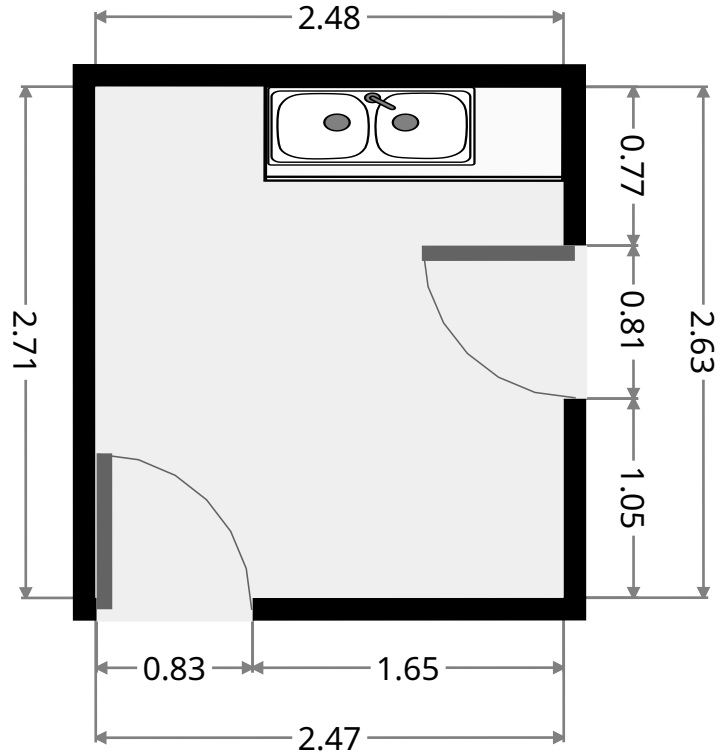
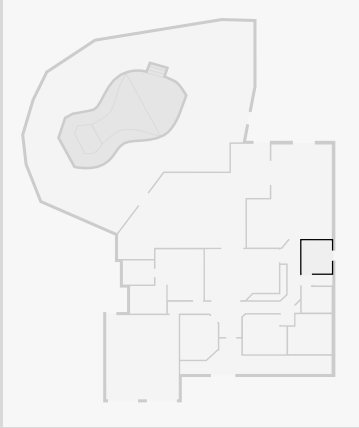

## Hall

Width: 0.87 m  
 Length: 0.99 m  
 Area: 0.86 m<sup>2</sup>  
 Perimeter: 3.72 m

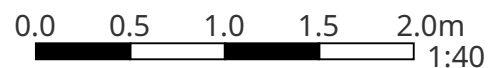
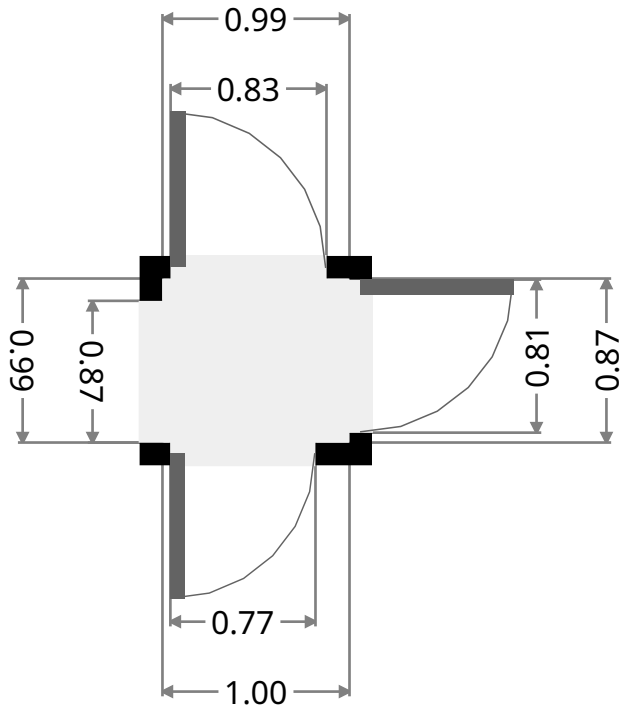
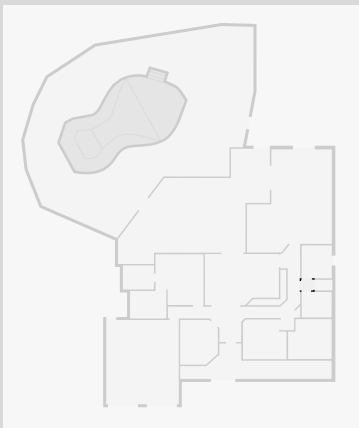

THIS FLOORPLAN IS PROVIDED WITHOUT WARRANTY OF ANY KIND. SENSOPIA DISCLAIMS ANY WARRANTY INCLUDING, WITHOUT LIMITATION, SATISFACTORY QUALITY OR ACCURACY OF DIMENSIONS.

# 8 Samuel Crescent

## Hall

Width:	7.95 m
Length:	10.88 m
Area	21.05 m <sup>2</sup>
Perimeter	39.26 m

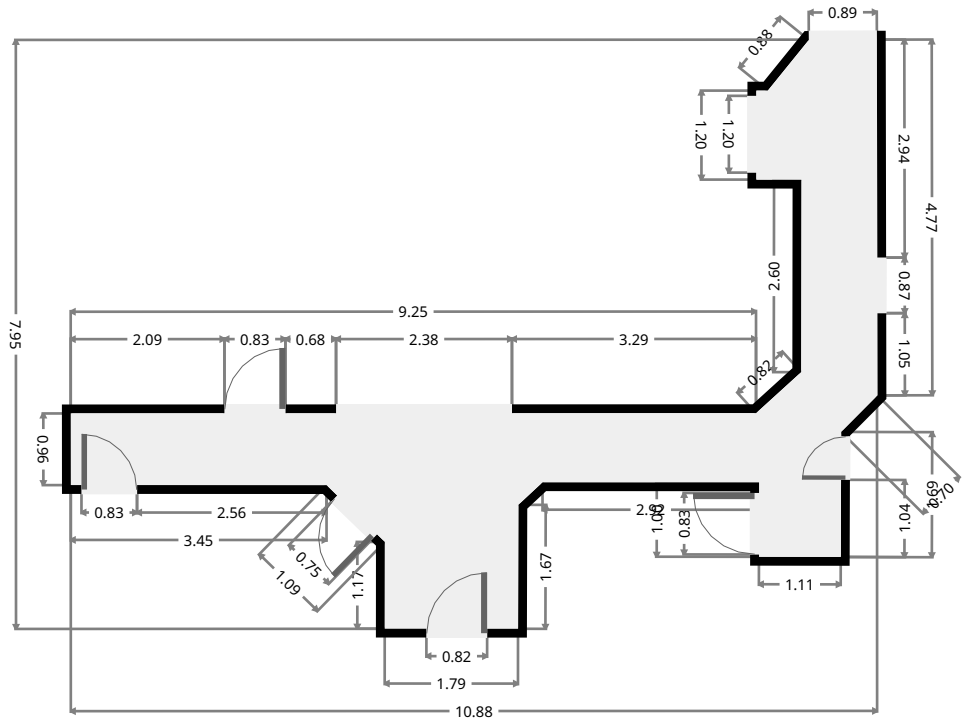
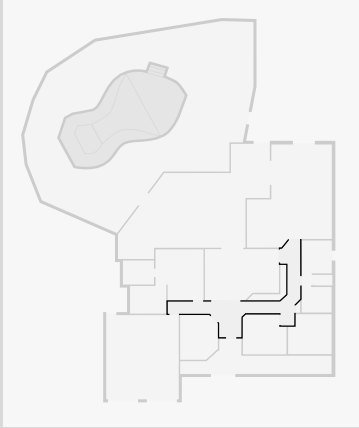

THIS FLOORPLAN IS PROVIDED WITHOUT WARRANTY OF ANY KIND. SENSOPIA DISCLAIMS ANY WARRANTY INCLUDING, WITHOUT LIMITATION, SATISFACTORY QUALITY OR ACCURACY OF DIMENSIONS.





# 8 Samuel Crescent

## Bedroom

Width: 3.28 m  
 Length: 3.58 m  
 Area: 11.12 m<sup>2</sup>  
 Perimeter: 13.58 m

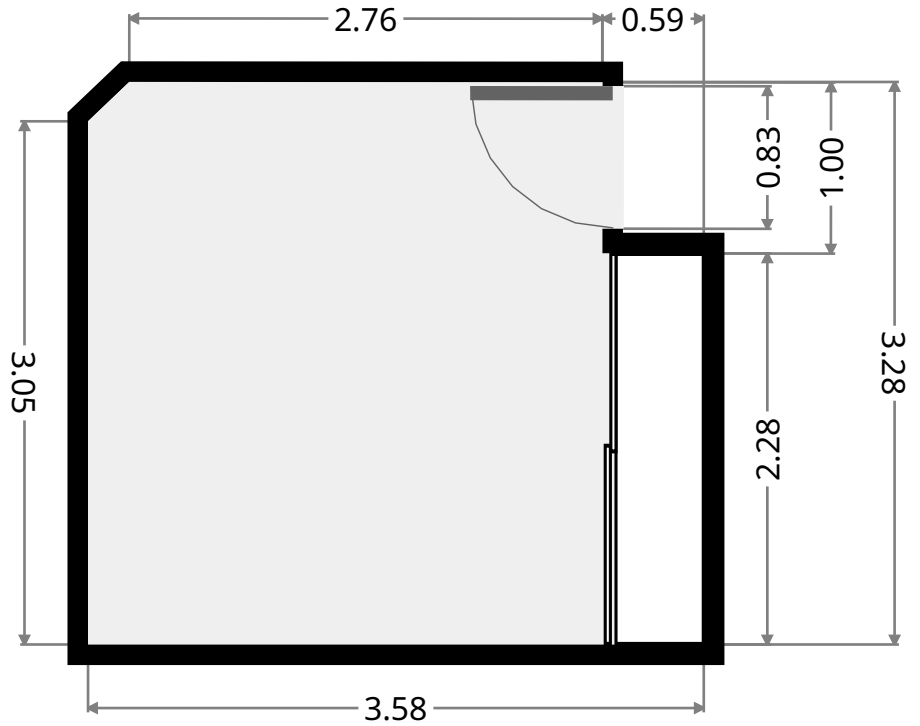
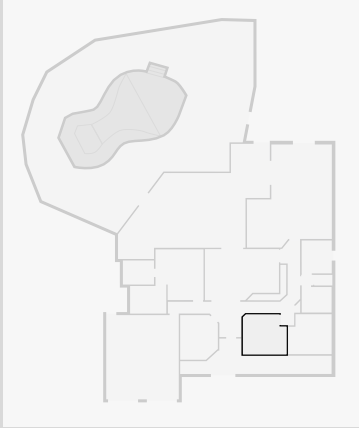

## Closet

Width: 2.92 m  
 Length: 3.22 m  
 Area: 2.50 m<sup>2</sup>  
 Perimeter: 11.68 m

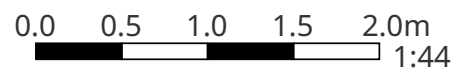
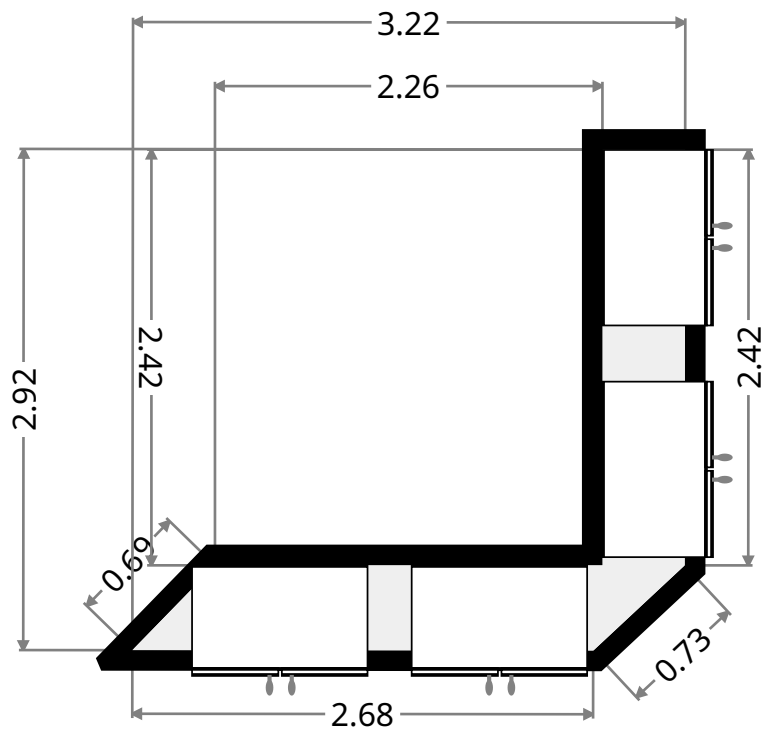
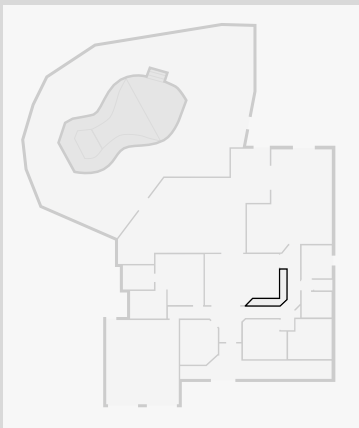

THIS FLOORPLAN IS PROVIDED WITHOUT WARRANTY OF ANY KIND. SENSOPIA DISCLAIMS ANY WARRANTY INCLUDING, WITHOUT LIMITATION, SATISFACTORY QUALITY OR ACCURACY OF DIMENSIONS.

# 8 Samuel Crescent

## Living Room

Width: 4.21 m  
 Length: 6.10 m  
 Area: 24.12 m<sup>2</sup>  
 Perimeter: 20.25 m

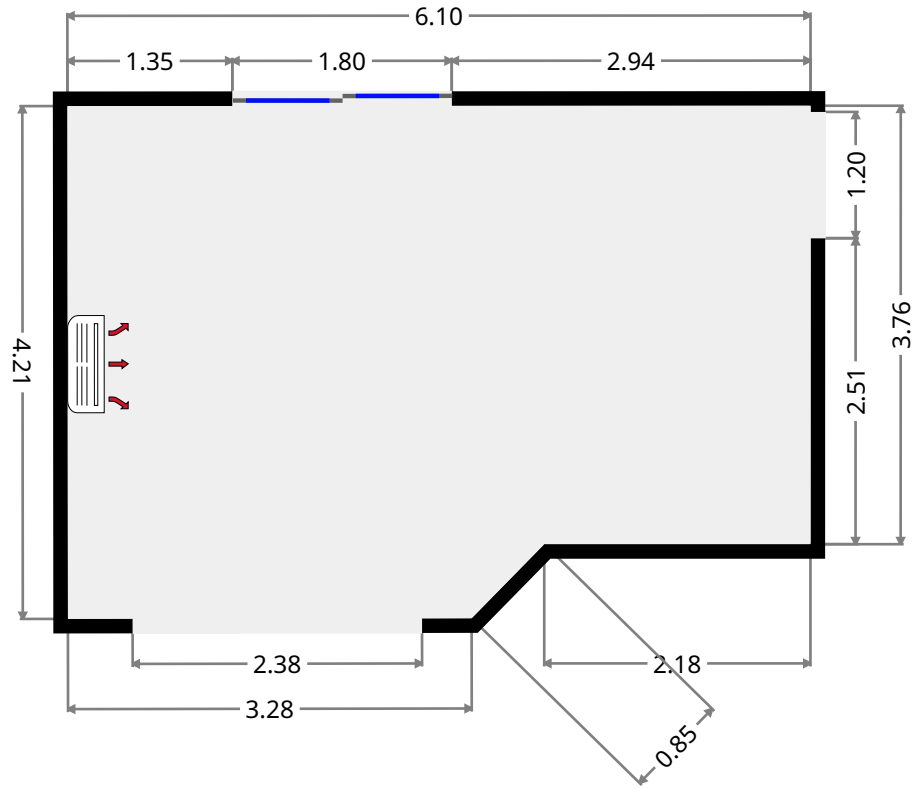
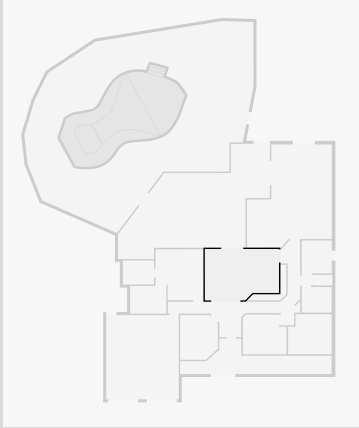

## Ensuite

Width: 2.27 m  
 Length: 2.98 m  
 Area: 6.76 m<sup>2</sup>  
 Perimeter: 10.50 m

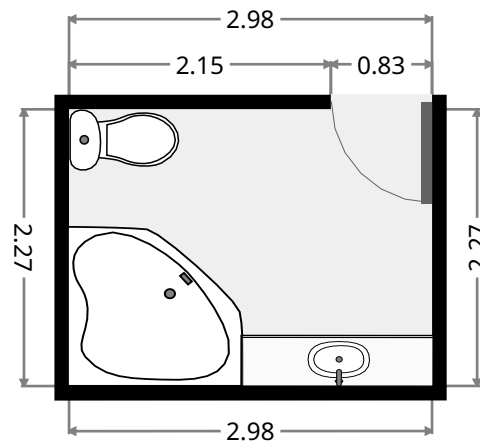
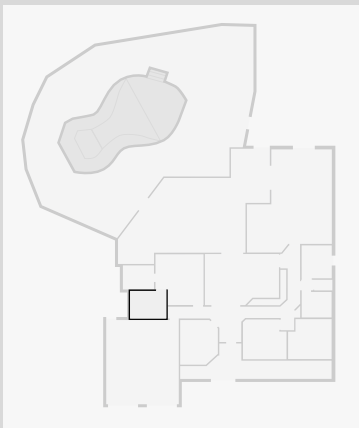

# 8 Samuel Crescent

## WIR

Width: 1.98 m  
 Length: 2.56 m  
 Area: 5.07 m<sup>2</sup>  
 Perimeter: 9.08 m

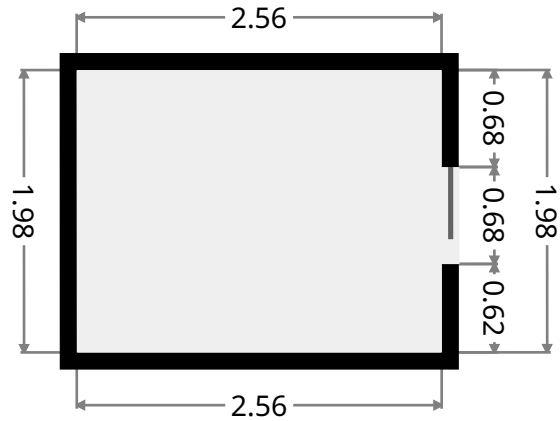
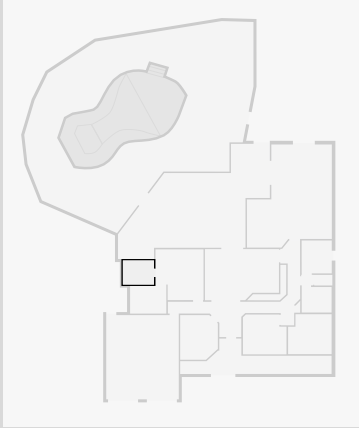

## Master Bedroom

Width: 3.95 m  
 Length: 4.17 m  
 Area: 15.23 m<sup>2</sup>  
 Perimeter: 16.26 m

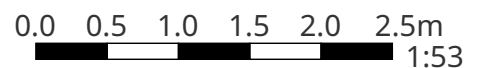
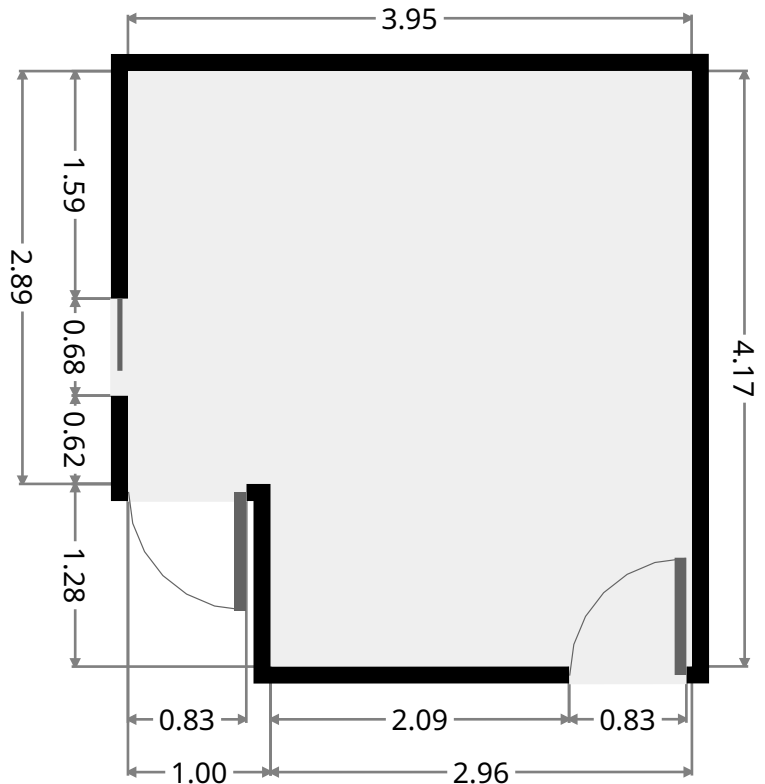
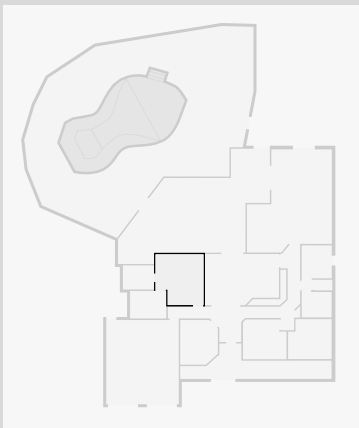

THIS FLOORPLAN IS PROVIDED WITHOUT WARRANTY OF ANY KIND. SENSOPIA DISCLAIMS ANY WARRANTY INCLUDING, WITHOUT LIMITATION, SATISFACTORY QUALITY OR ACCURACY OF DIMENSIONS.

# 8 Samuel Crescent

## Garage

Width: 5.97 m  
 Length: 6.93 m  
 Area: 41.37 m<sup>2</sup>  
 Perimeter: 25.80 m

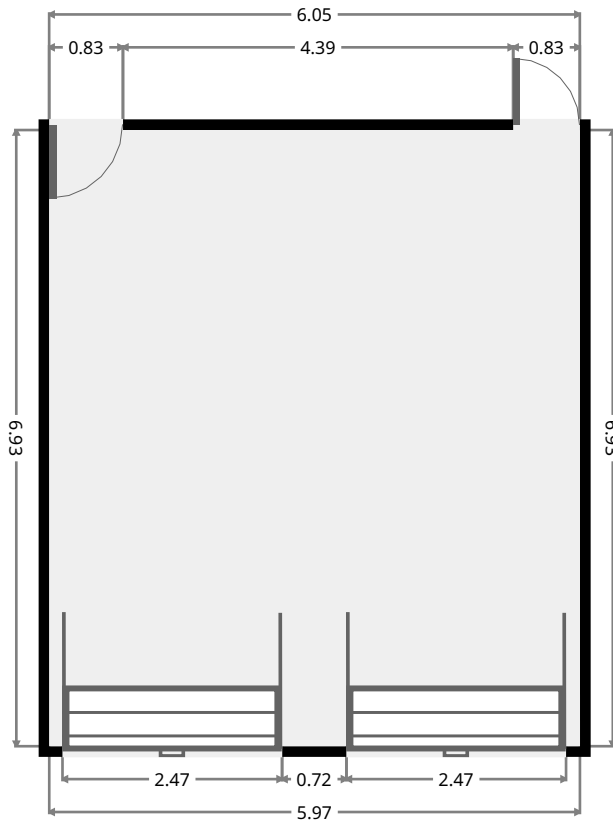
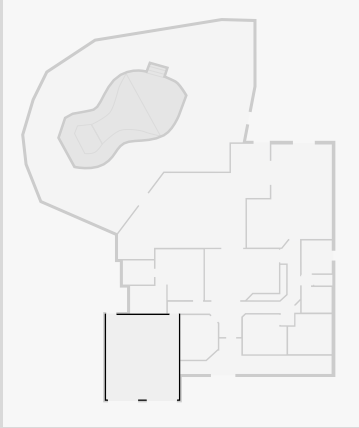

## Bedroom

Width: 3.10 m  
 Length: 3.67 m  
 Area: 10.70 m<sup>2</sup>  
 Perimeter: 12.60 m

