

# 8 Bottlebrush Street

## Ground Floor

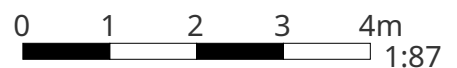

THIS FLOORPLAN IS PROVIDED WITHOUT WARRANTY OF ANY KIND. SENSOPIA DISCLAIMS ANY WARRANTY INCLUDING, WITHOUT LIMITATION, SATISFACTORY QUALITY OR ACCURACY OF DIMENSIONS.



# 8 Bottlebrush Street

## Hall

Width: 3.62 m  
 Length: 6.00 m  
 Area: 10.95 m<sup>2</sup>  
 Perimeter: 19.23 m

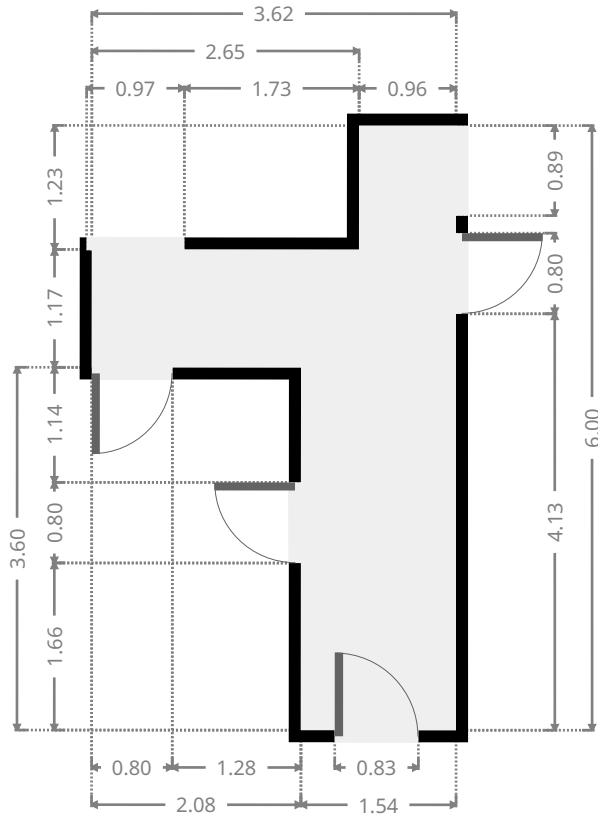
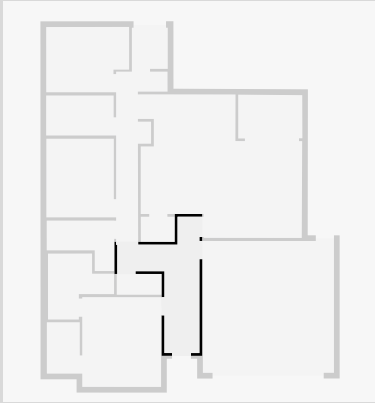

## Master Bedroom

Width: 3.47 m  
 Length: 3.95 m  
 Area: 13.72 m<sup>2</sup>  
 Perimeter: 14.84 m

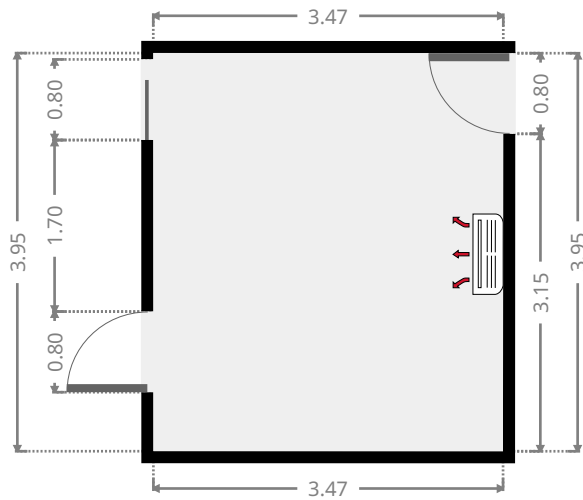
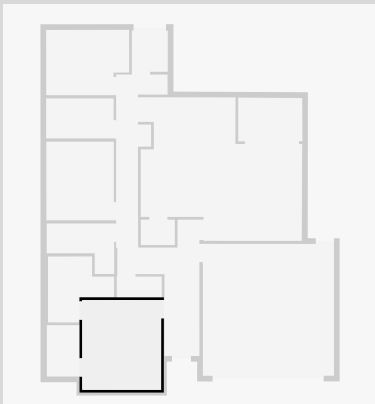

# 8 Bottlebrush Street

## WIR

Width: 1.45 m  
 Length: 2.26 m  
 Area: 3.28 m<sup>2</sup>  
 Perimeter: 7.42 m

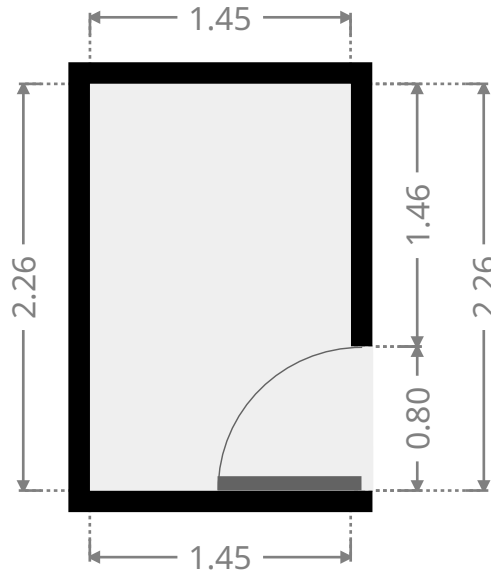
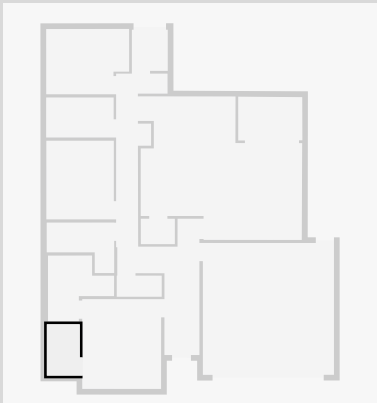

## Bathroom

Width: 2.90 m  
 Length: 2.91 m  
 Area: 5.85 m<sup>2</sup>  
 Perimeter: 11.62 m

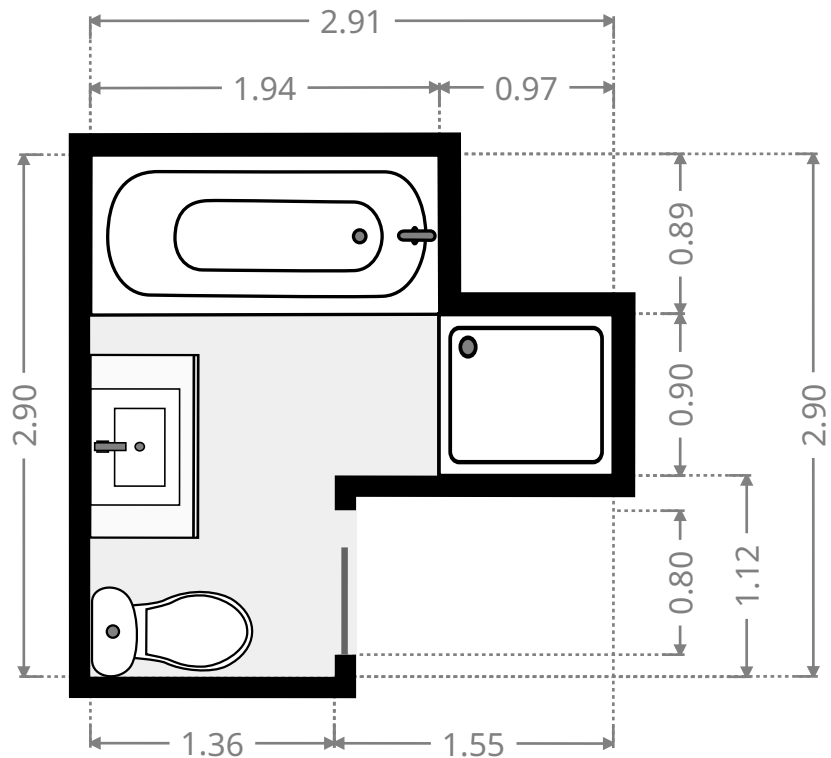
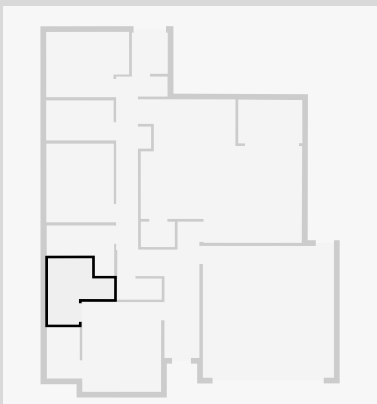

THIS FLOORPLAN IS PROVIDED WITHOUT WARRANTY OF ANY KIND. SENSOPIA DISCLAIMS ANY WARRANTY INCLUDING, WITHOUT LIMITATION, SATISFACTORY QUALITY OR ACCURACY OF DIMENSIONS.

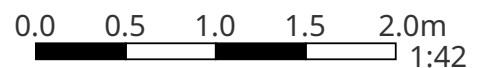

# 8 Bottlebrush Street

## Toilet / Half Bath

Width: 0.93 m  
Length: 1.98 m  
Area: 1.84 m<sup>2</sup>  
Perimeter: 5.82 m

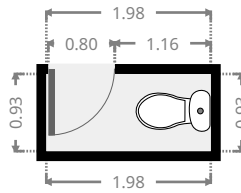
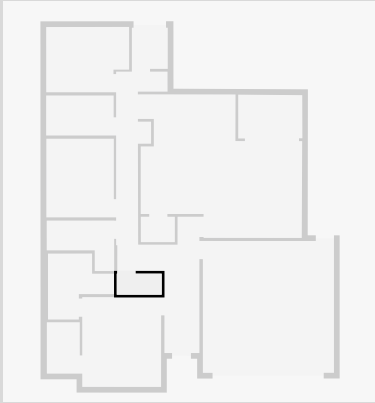

## Hall

Width: 2.26 m  
Length: 7.52 m  
Area: 8.94 m<sup>2</sup>  
Perimeter: 20.74 m

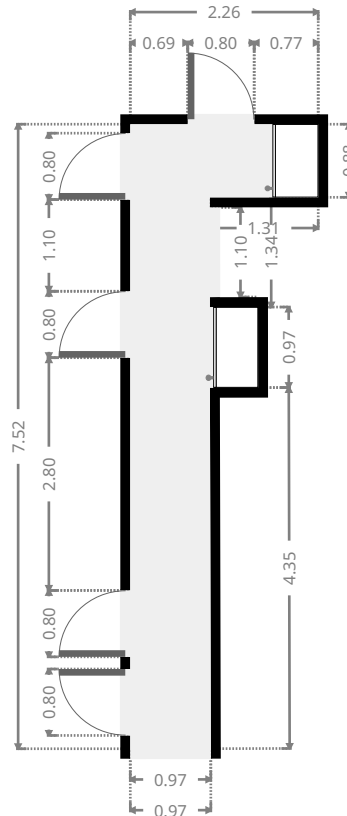
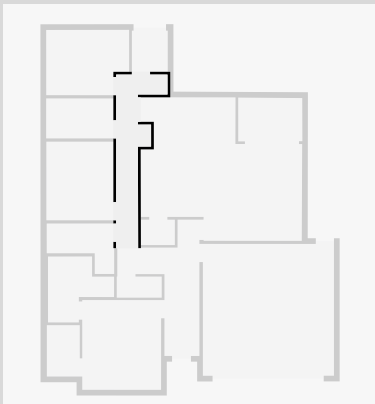

THIS FLOORPLAN IS PROVIDED WITHOUT WARRANTY OF ANY KIND. SENSOPIA DISCLAIMS ANY WARRANTY INCLUDING, WITHOUT LIMITATION, SATISFACTORY QUALITY OR ACCURACY OF DIMENSIONS.

# 8 Bottlebrush Street

## Bathroom

Width: 2.22 m  
Length: 2.97 m  
Area: 4.67 m<sup>2</sup>  
Perimeter: 10.38 m

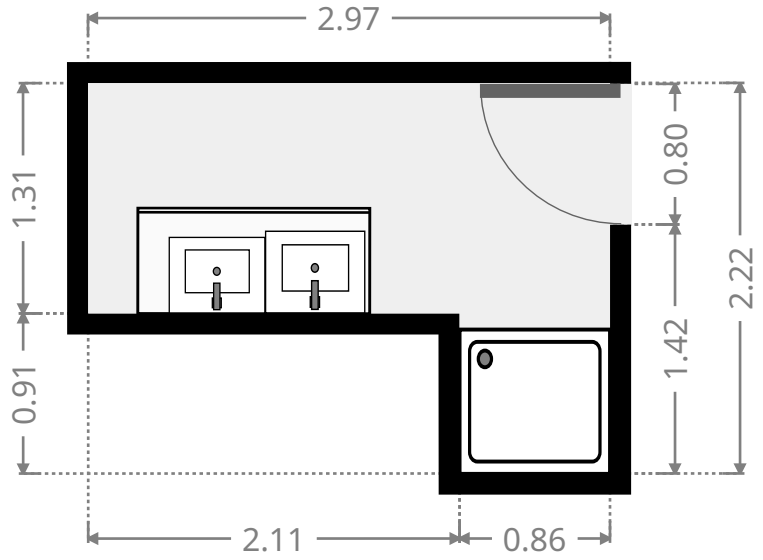
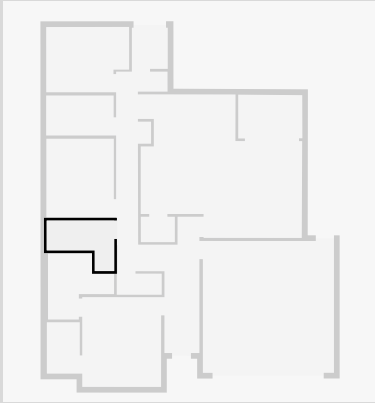

## Bedroom

Width: 2.97 m  
Length: 3.46 m  
Area: 10.28 m<sup>2</sup>  
Perimeter: 12.86 m

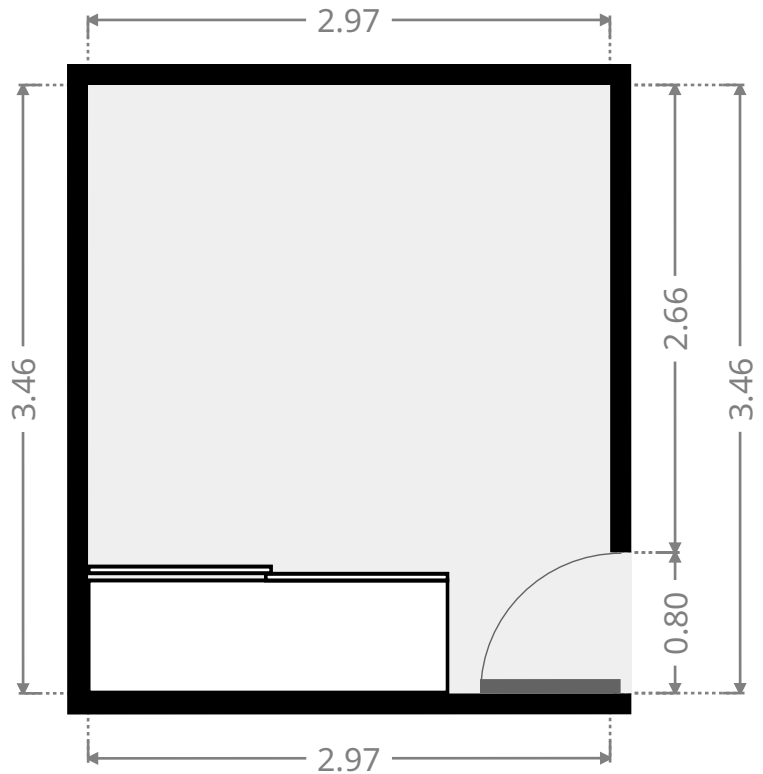
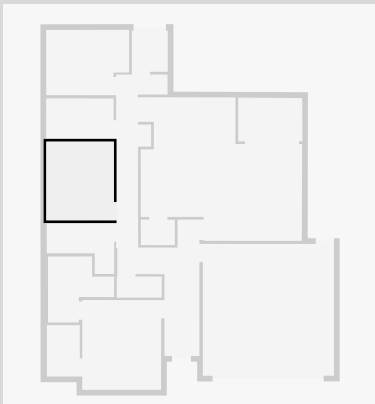

THIS FLOORPLAN IS PROVIDED WITHOUT WARRANTY OF ANY KIND. SENSOPIA DISCLAIMS ANY WARRANTY INCLUDING, WITHOUT LIMITATION, SATISFACTORY QUALITY OR ACCURACY OF DIMENSIONS.

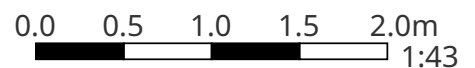

# 8 Bottlebrush Street

## Study

Width: 1.76 m  
Length: 2.97 m  
Area: 5.23 m<sup>2</sup>  
Perimeter: 9.46 m

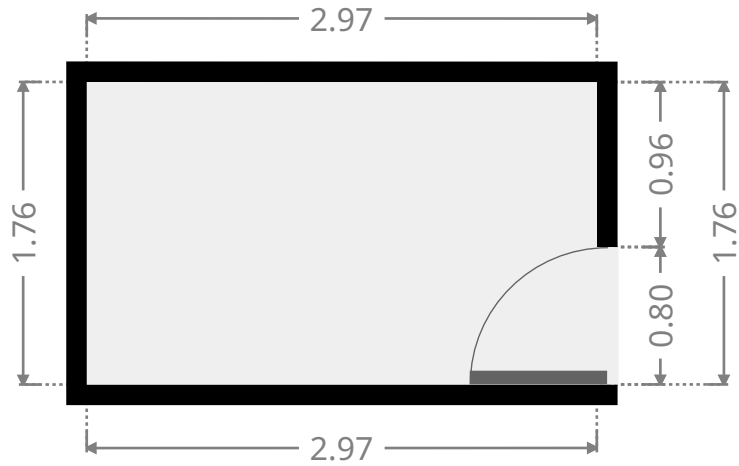
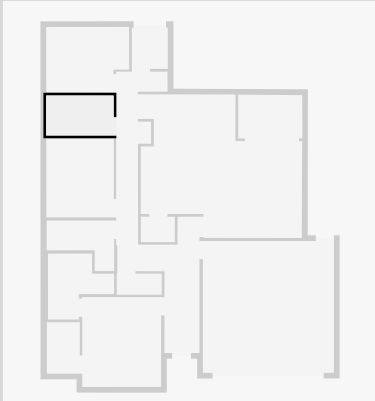

## Bedroom

Width: 2.88 m  
Length: 3.65 m  
Area: 9.80 m<sup>2</sup>  
Perimeter: 13.05 m

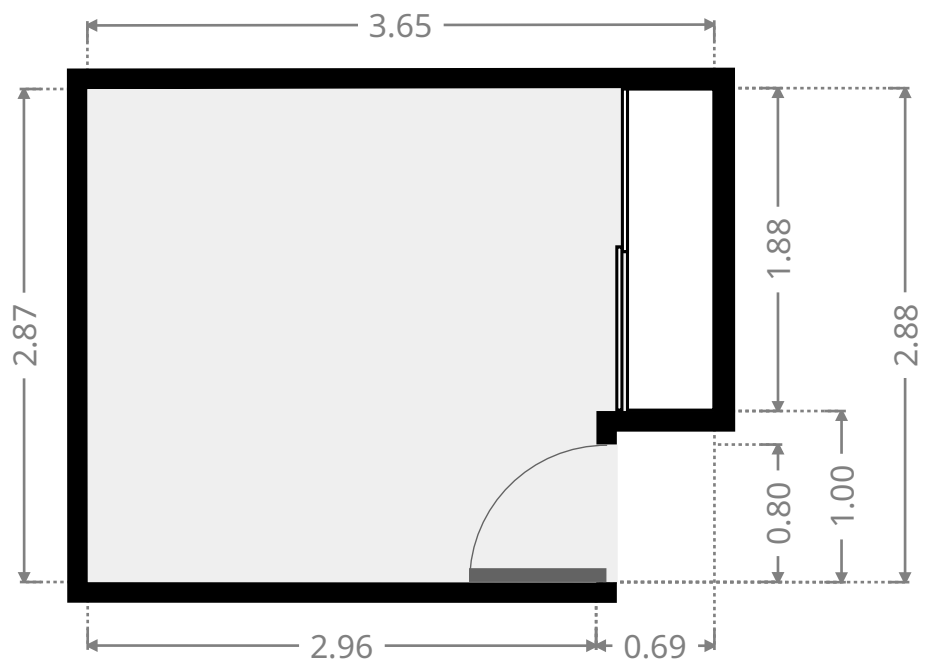
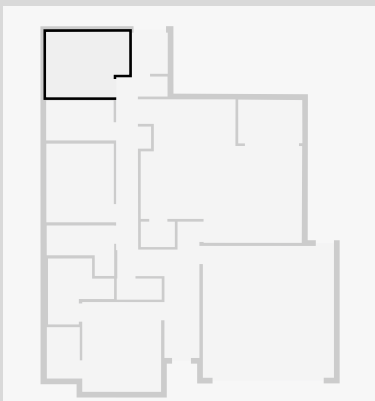

# 8 Bottlebrush Street

## Laundry Room

Width: 1.58 m  
 Length: 1.81 m  
 Area: 2.86 m<sup>2</sup>  
 Perimeter: 6.78 m

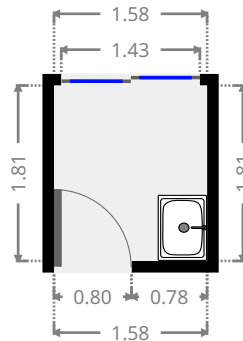
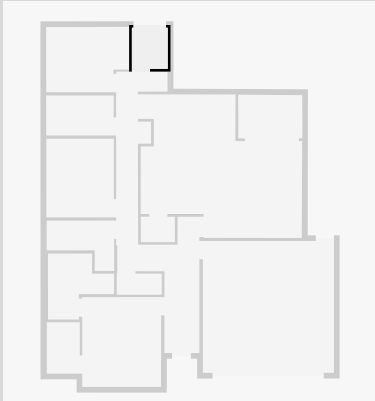

## Living/Kitchen/Dining

Width: 6.31 m  
 Length: 7.16 m  
 Area: 35.25 m<sup>2</sup>  
 Perimeter: 28.07 m

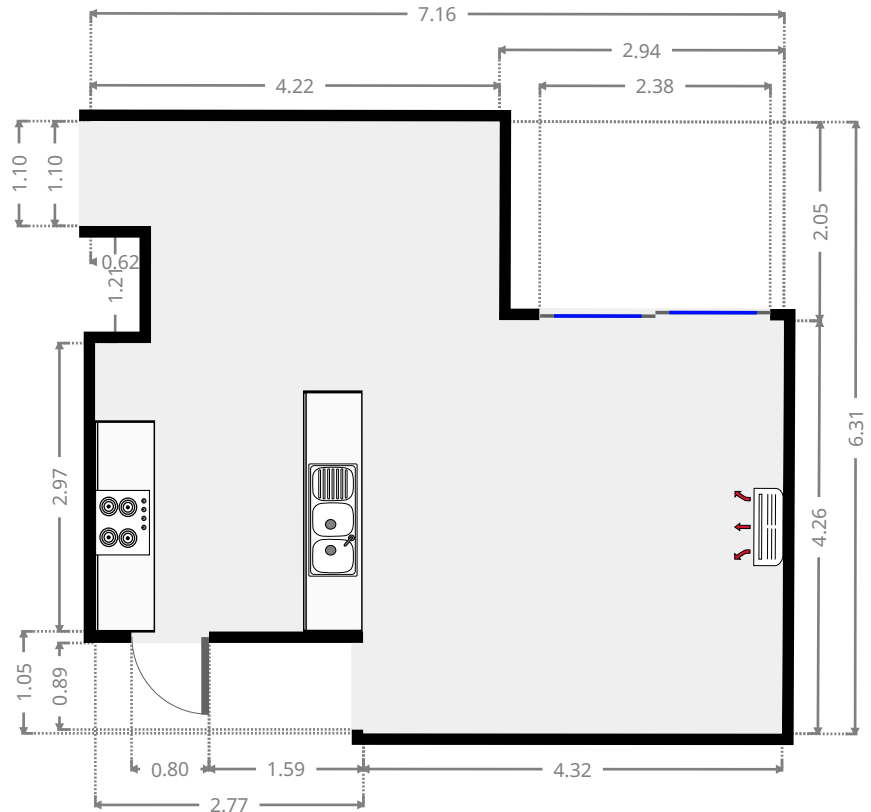
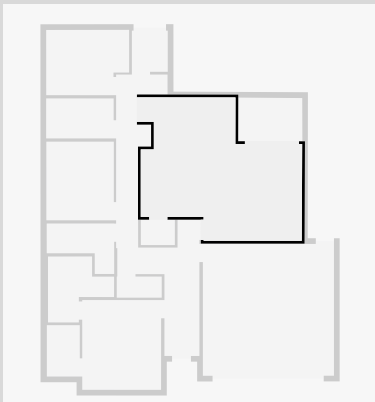

THIS FLOORPLAN IS PROVIDED WITHOUT WARRANTY OF ANY KIND. SENSOPIA DISCLAIMS ANY WARRANTY INCLUDING, WITHOUT LIMITATION, SATISFACTORY QUALITY OR ACCURACY OF DIMENSIONS.

# 8 Bottlebrush Street

## Pantry

Width: 1.12 m  
Length: 1.50 m  
Area: 1.68 m<sup>2</sup>  
Perimeter: 5.23 m

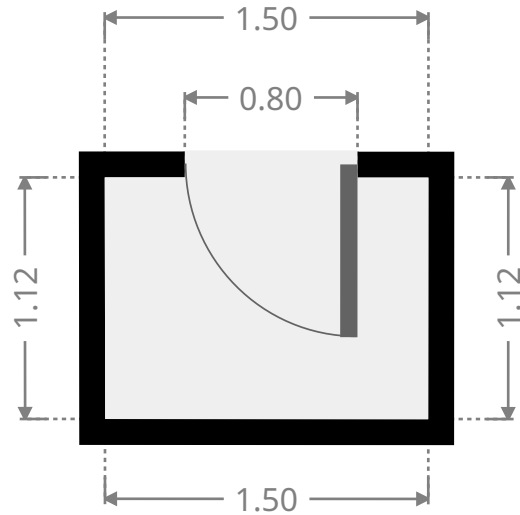
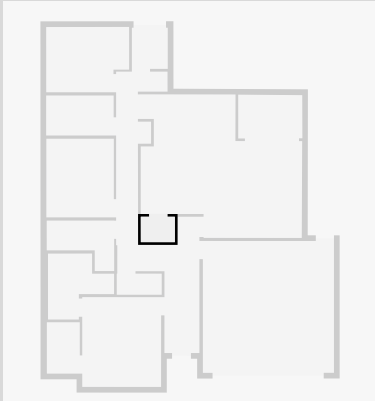

## Outdoor Area

Width: 1.93 m  
Length: 2.82 m  
Area: 5.40 m<sup>2</sup>  
Perimeter: 9.47 m

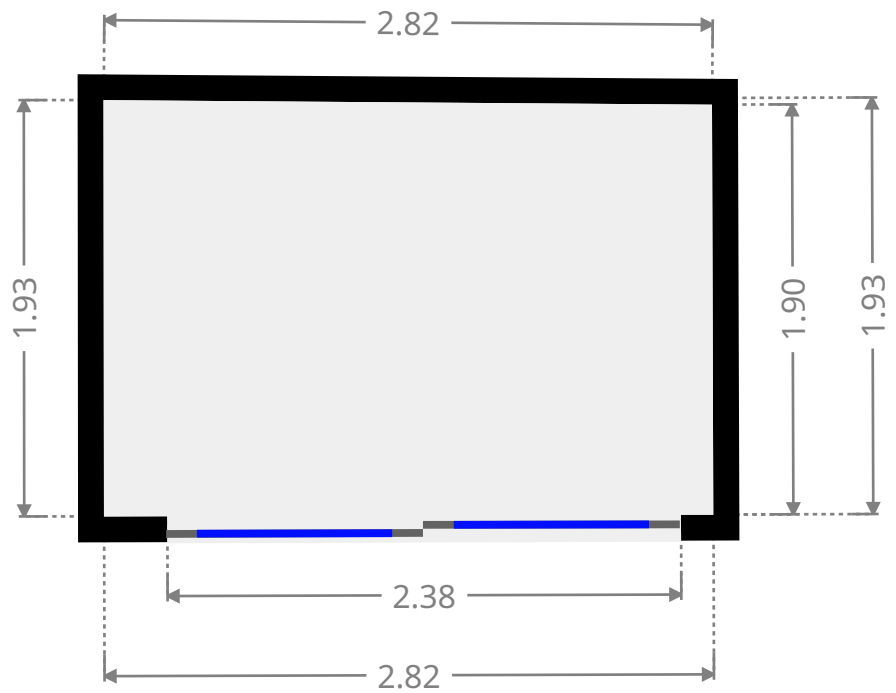
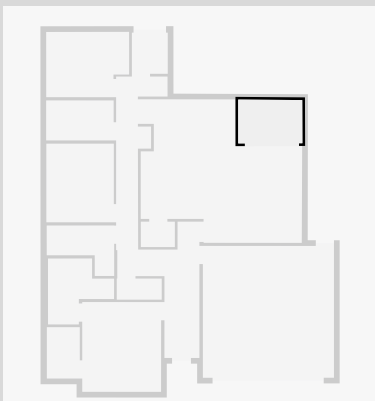



# 8 Bottlebrush Street

## Garage

Width: 5.77 m  
Length: 5.81 m  
Area: 33.48 m<sup>2</sup>  
Perimeter: 23.15 m

