

64 Alexandra Street

Ground Floor

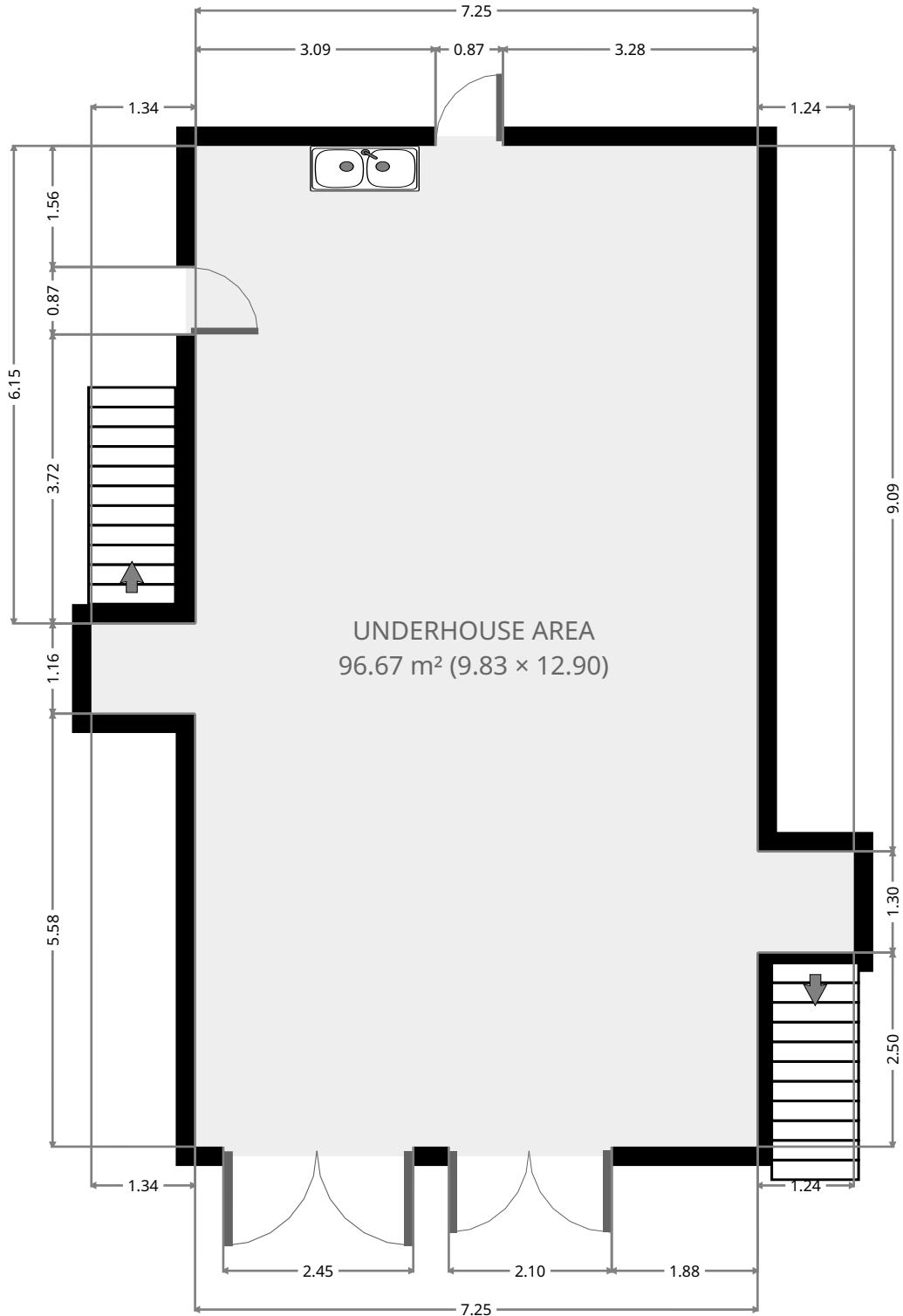

THIS FLOORPLAN IS PROVIDED WITHOUT WARRANTY OF ANY KIND. SENSOPIA DISCLAIMS ANY WARRANTY INCLUDING, WITHOUT LIMITATION, SATISFACTORY QUALITY OR ACCURACY OF DIMENSIONS.



64 Alexandra Street

Underhouse Area

Width: 9.83 m
Length: 12.90 m
Area: 96.67 m²
Perimeter: 45.45 m

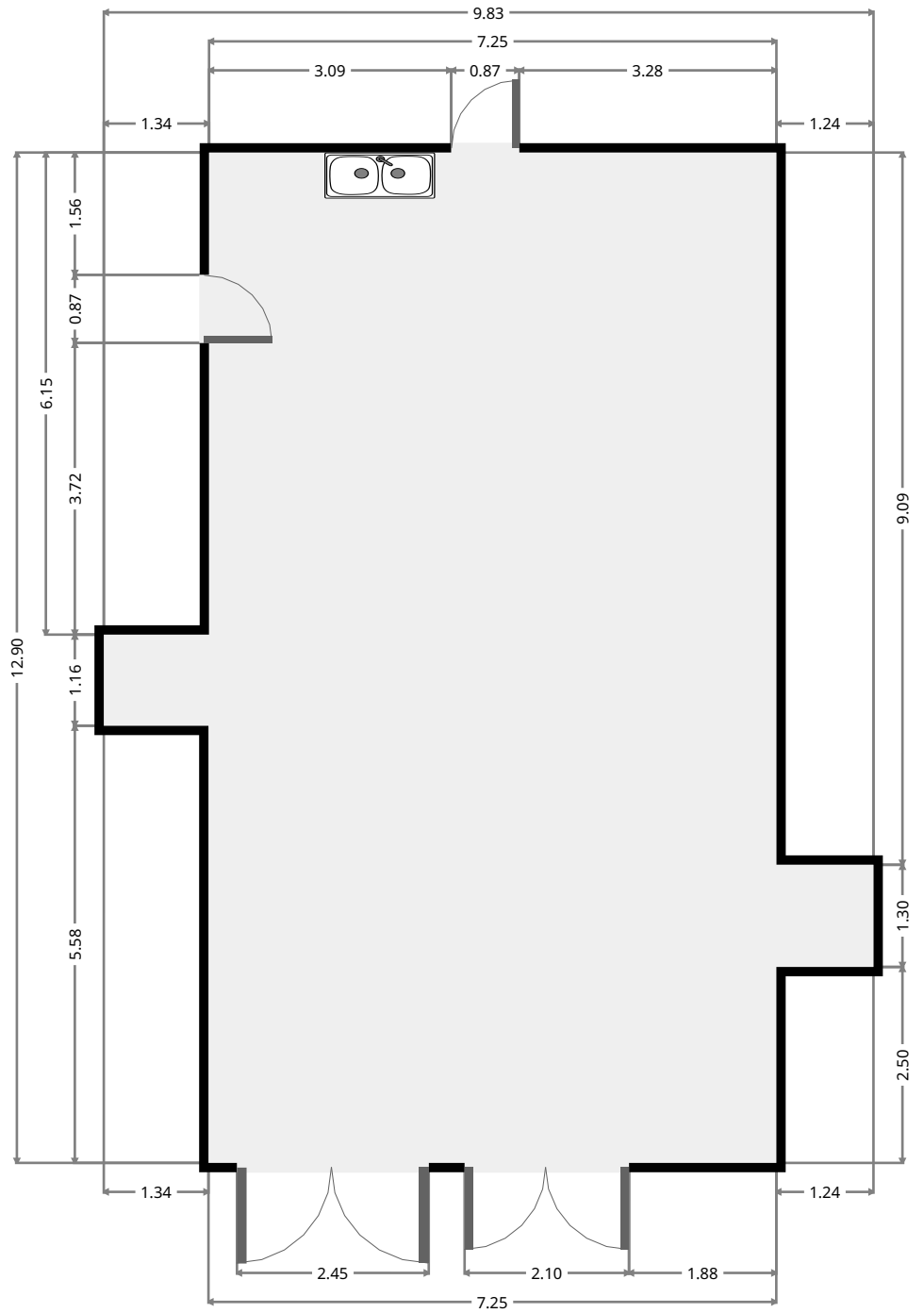
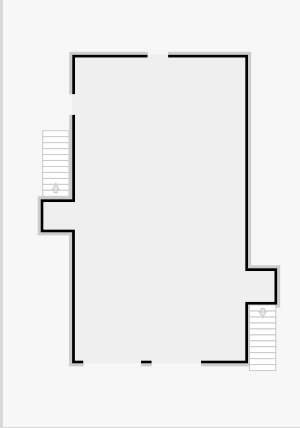

THIS FLOORPLAN IS PROVIDED WITHOUT WARRANTY OF ANY KIND. SENSOPIA DISCLAIMS ANY WARRANTY INCLUDING, WITHOUT LIMITATION, SATISFACTORY QUALITY OR ACCURACY OF DIMENSIONS.



64 Alexandra Street

1st Floor

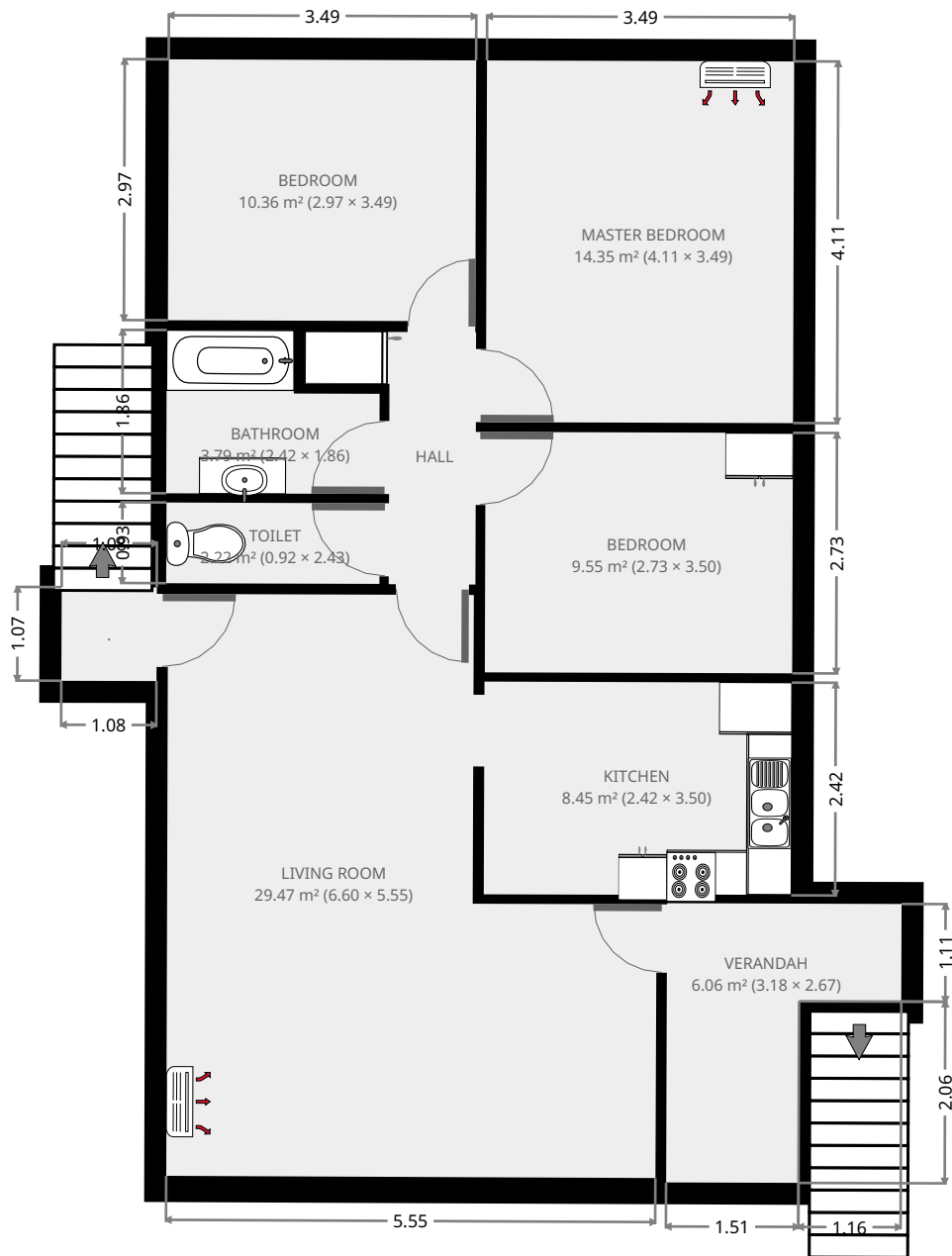

THIS FLOORPLAN IS PROVIDED WITHOUT WARRANTY OF ANY KIND. SENSOPIA DISCLAIMS ANY WARRANTY INCLUDING, WITHOUT LIMITATION, SATISFACTORY QUALITY OR ACCURACY OF DIMENSIONS.



64 Alexandra Street

Living Room

Width: 5.55 m
 Length: 6.60 m
 Area: 29.47 m²
 Perimeter: 24.36 m

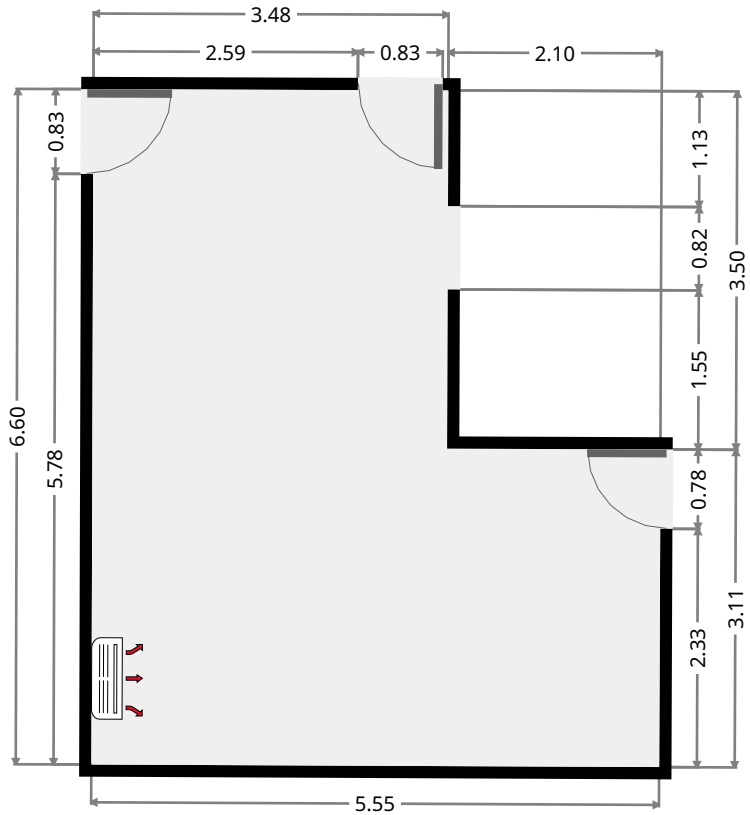
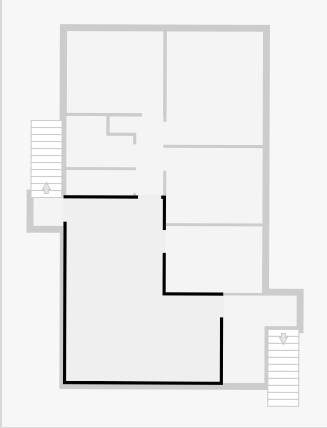

Hall

Width: 1.95 m
 Length: 2.87 m
 Area: 3.39 m²
 Perimeter: 9.63 m

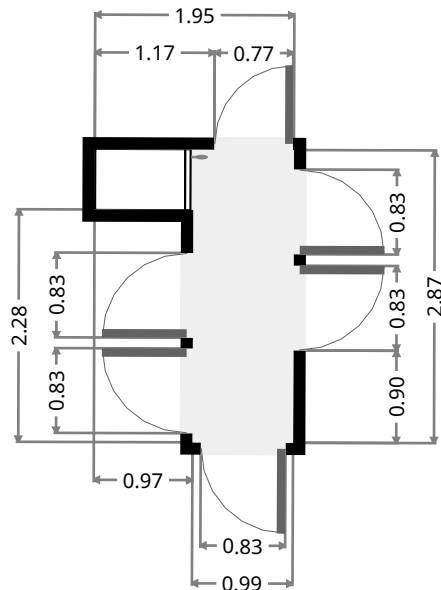
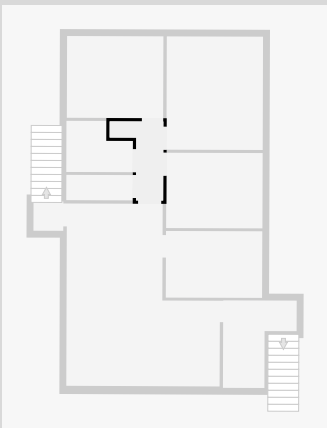

THIS FLOORPLAN IS PROVIDED WITHOUT WARRANTY OF ANY KIND. SENSOPIA DISCLAIMS ANY WARRANTY INCLUDING, WITHOUT LIMITATION, SATISFACTORY QUALITY OR ACCURACY OF DIMENSIONS.



64 Alexandra Street

Kitchen

Width: 2.42 m
Length: 3.50 m
Area: 8.45 m²
Perimeter: 11.82 m

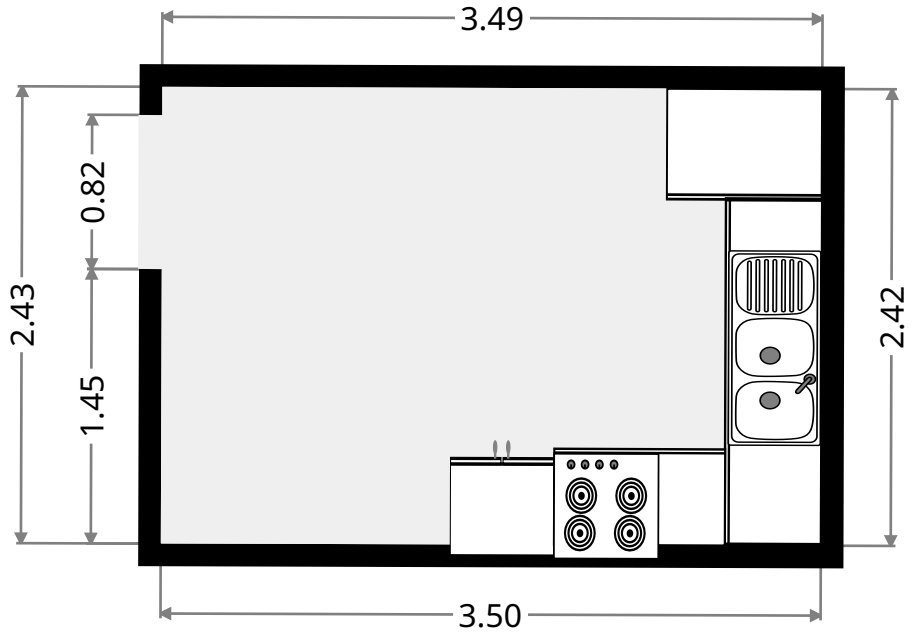
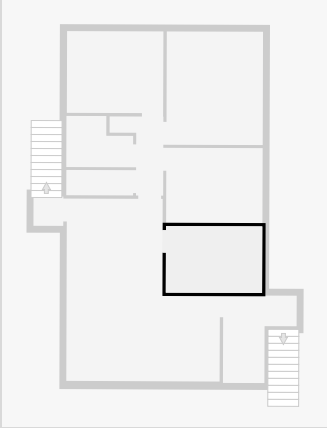

Bedroom

Width: 2.73 m
Length: 3.50 m
Area: 9.55 m²
Perimeter: 12.45 m

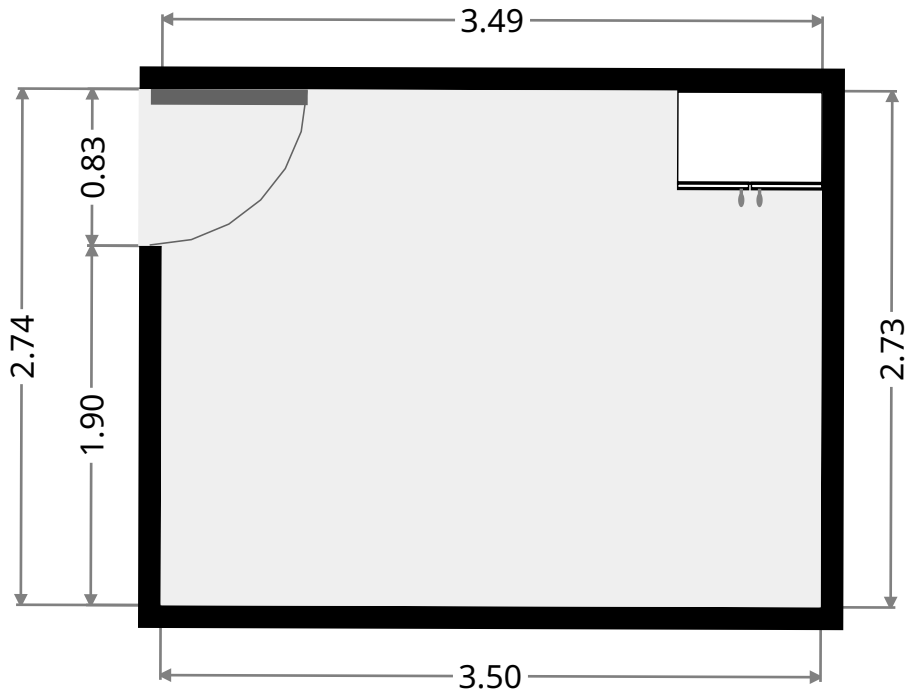
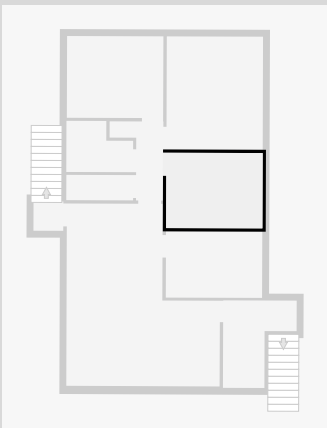

64 Alexandra Street

Toilet

Width: 0.92 m
Length: 2.43 m
Area: 2.22 m²
Perimeter: 6.68 m

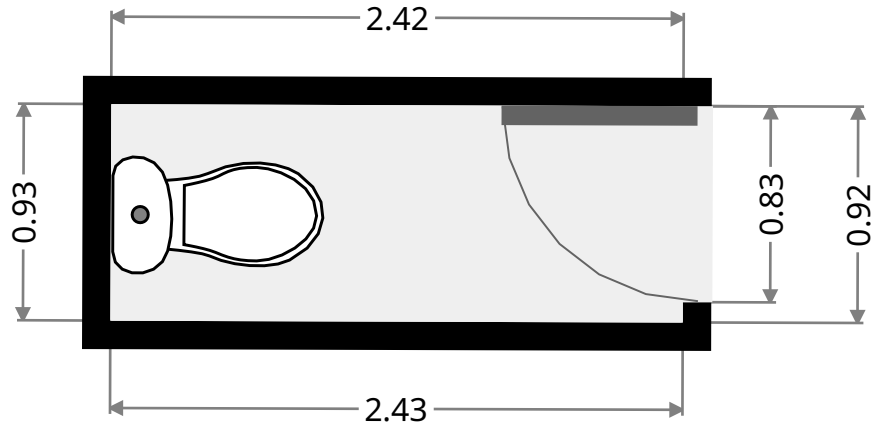

Bathroom

Width: 1.86 m
Length: 2.42 m
Area: 3.79 m²
Perimeter: 8.55 m

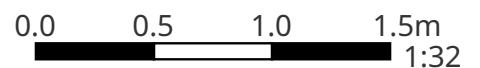
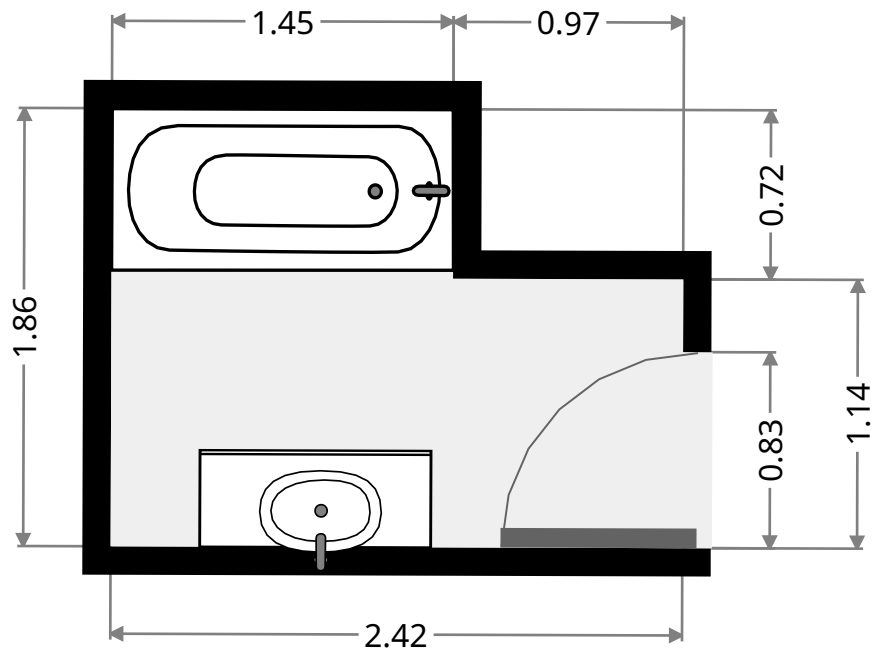
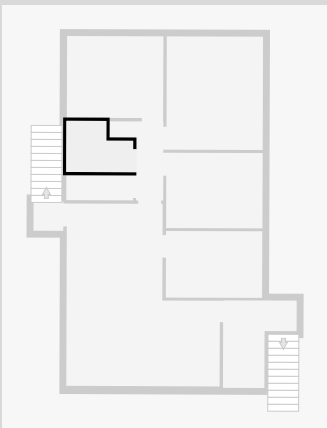

64 Alexandra Street

Bedroom

Width: 2.97 m
Length: 3.49 m
Area: 10.36 m²
Perimeter: 12.92 m

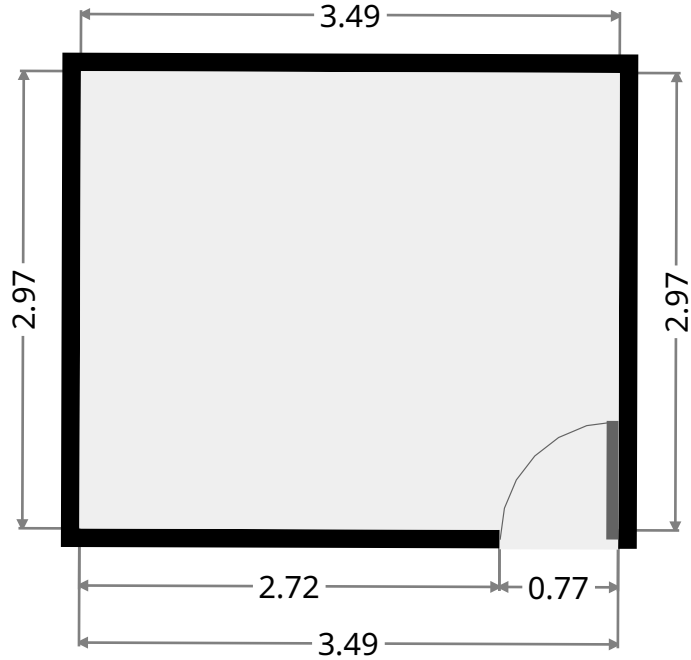
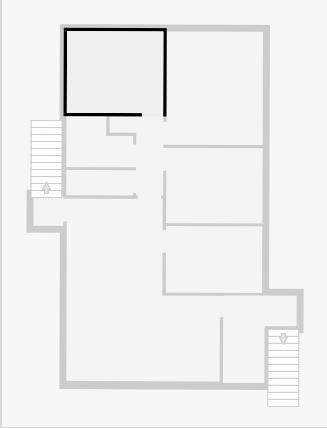

Master Bedroom

Width: 3.49 m
Length: 4.11 m
Area: 14.35 m²
Perimeter: 15.20 m

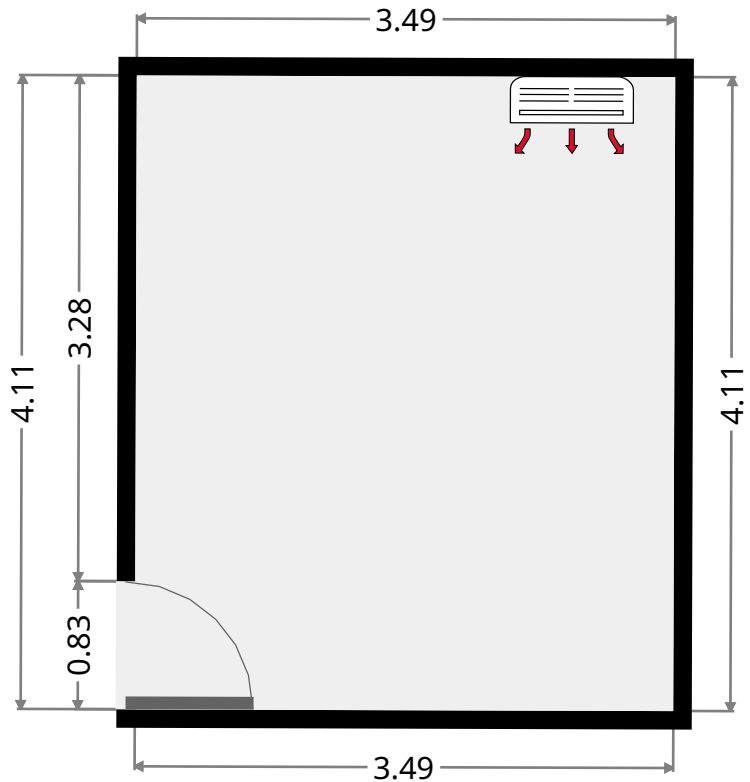
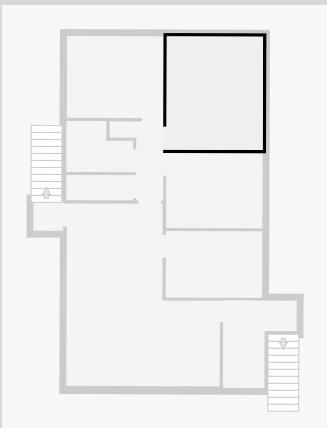

64 Alexandra Street

•
 Width: 1.06 m
 Length: 1.08 m
 Area: 1.15 m²
 Perimeter: 4.29 m

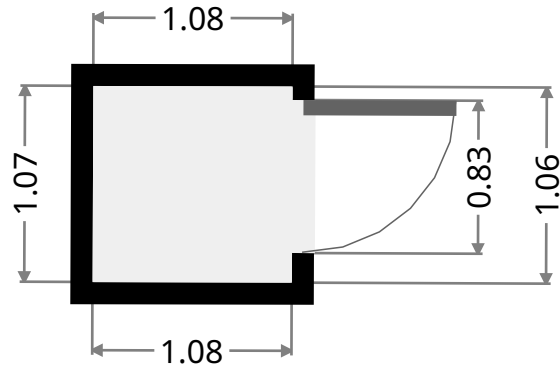
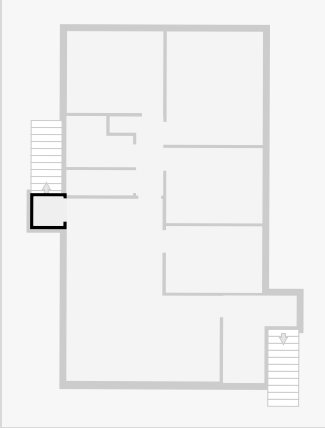

Verandah

Width: 2.67 m
 Length: 3.18 m
 Area: 6.06 m²
 Perimeter: 11.68 m

