

61 Perrott Drive

Ground Floor

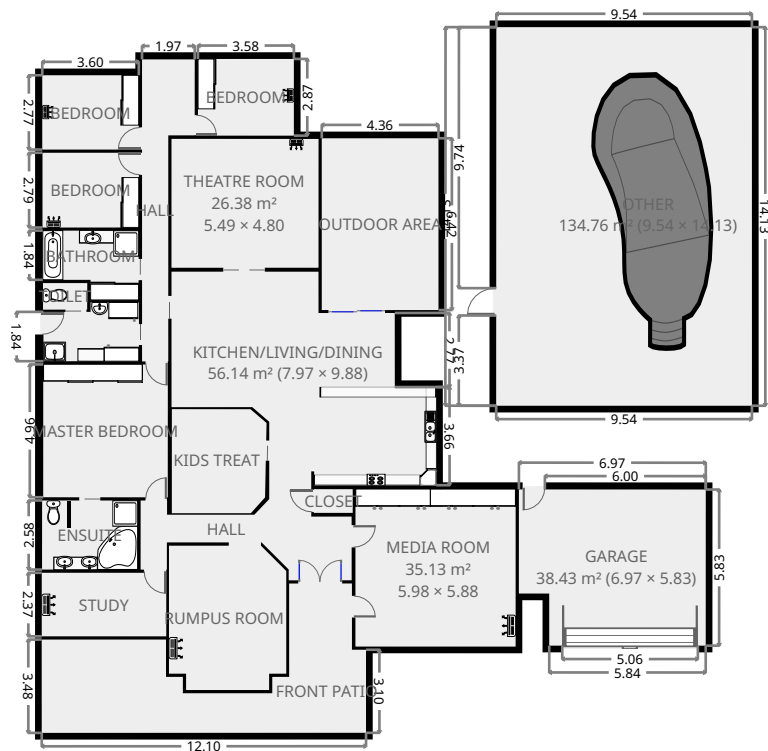
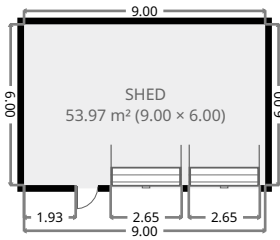
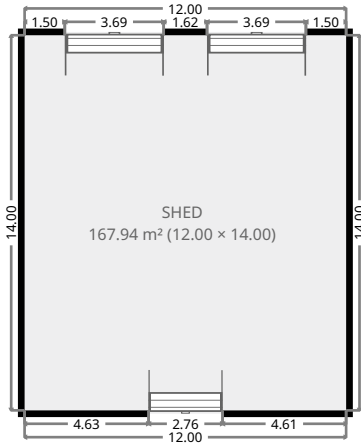

THIS FLOORPLAN IS PROVIDED WITHOUT WARRANTY OF ANY KIND. SENSOPIA DISCLAIMS ANY WARRANTY INCLUDING, WITHOUT LIMITATION, SATISFACTORY QUALITY OR ACCURACY OF DIMENSIONS.

61 Perrott Drive

Bedroom

Width: 2.87 m
Length: 3.58 m
Area: 10.24 m²
Perimeter: 12.88 m

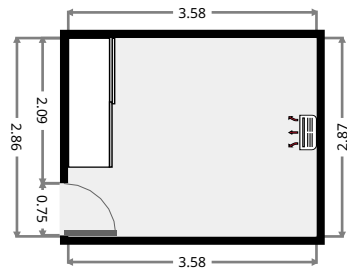
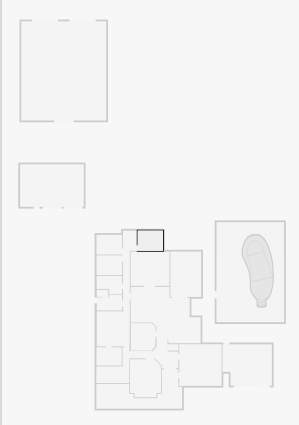

Front Patio

Width: 5.57 m
Length: 12.10 m
Area: 38.38 m²
Perimeter: 39.35 m

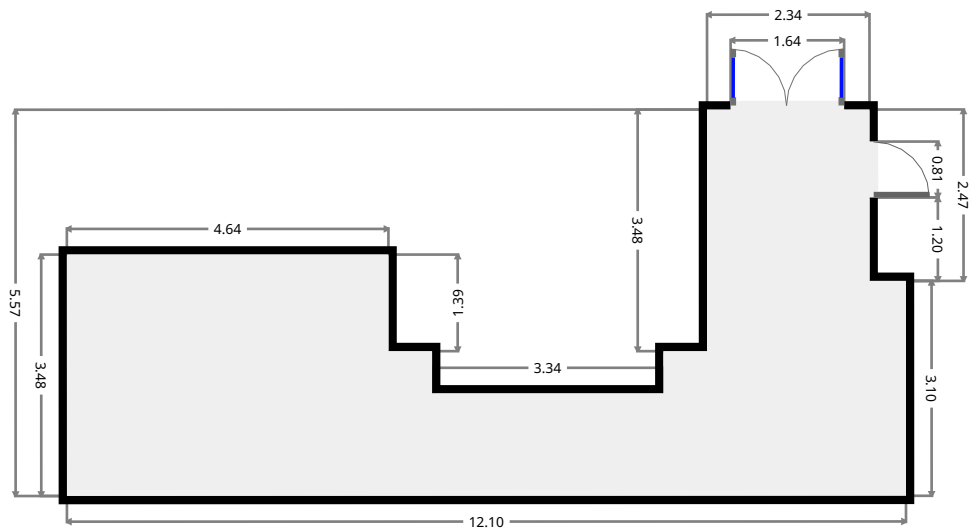
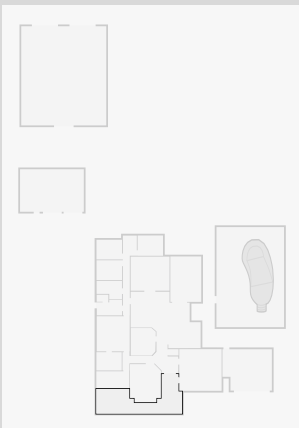

61 Perrott Drive

Shed

Width: 12.00 m
Length: 14.00 m
Area: 167.94 m²
Perimeter: 51.99 m

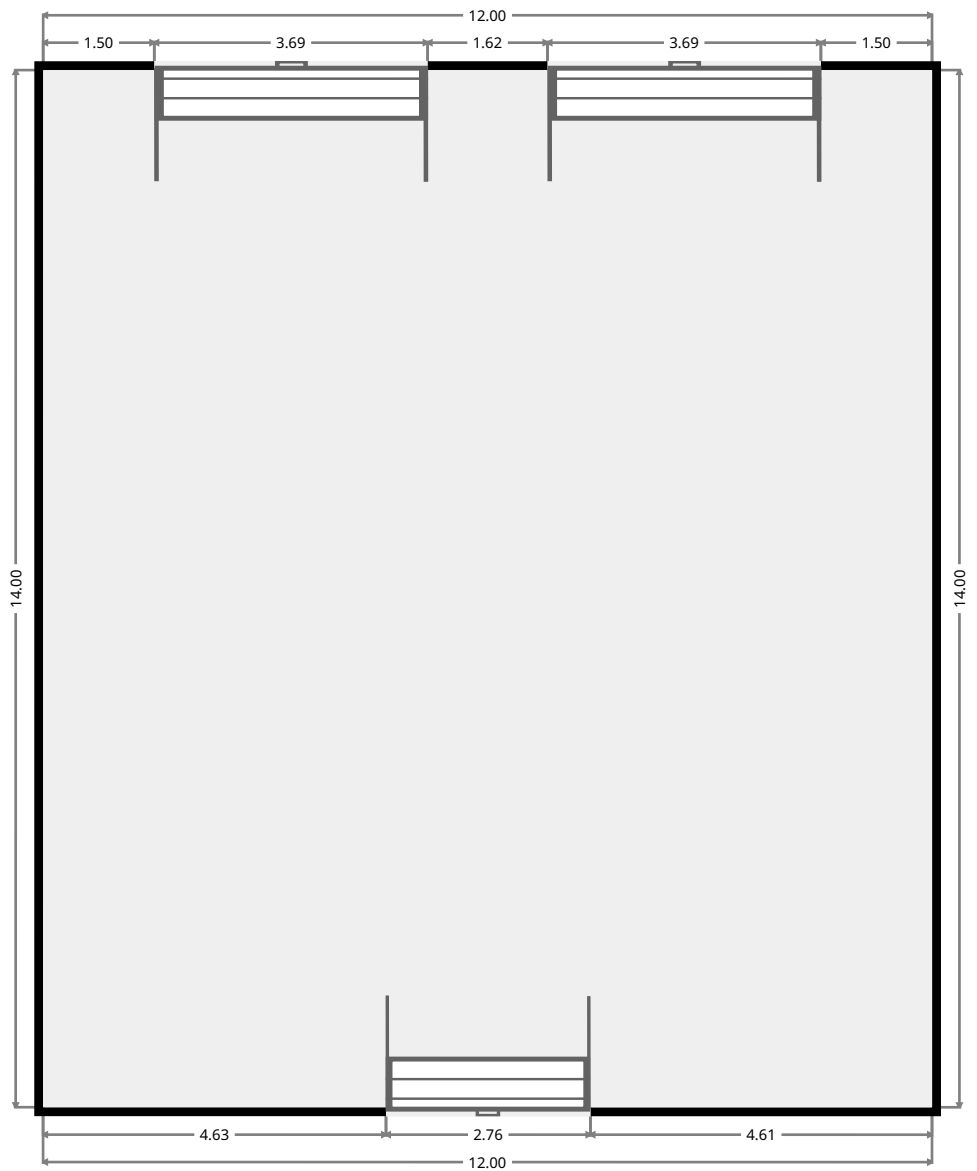
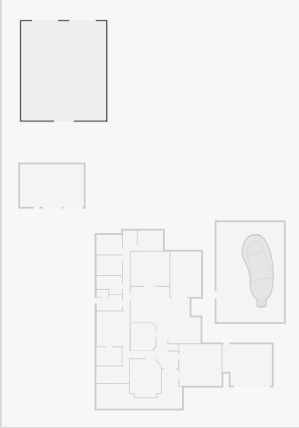

THIS FLOORPLAN IS PROVIDED WITHOUT WARRANTY OF ANY KIND. SENSOPIA DISCLAIMS ANY WARRANTY INCLUDING, WITHOUT LIMITATION, SATISFACTORY QUALITY OR ACCURACY OF DIMENSIONS.



61 Perrott Drive

Shed

Width: 6.00 m
 Length: 9.00 m
 Area: 53.97 m²
 Perimeter: 29.99 m

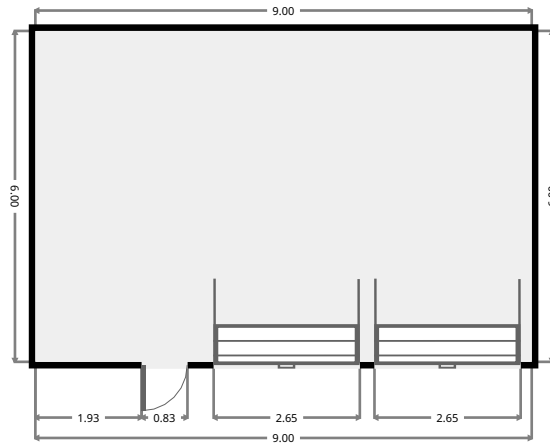
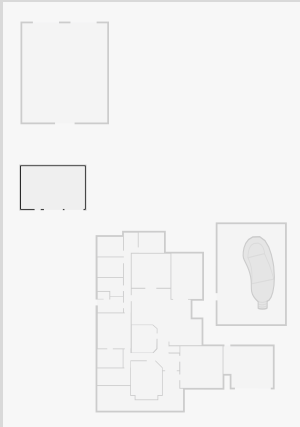

Other

Width: 9.54 m
 Length: 14.13 m
 Area: 134.76 m²
 Perimeter: 47.33 m

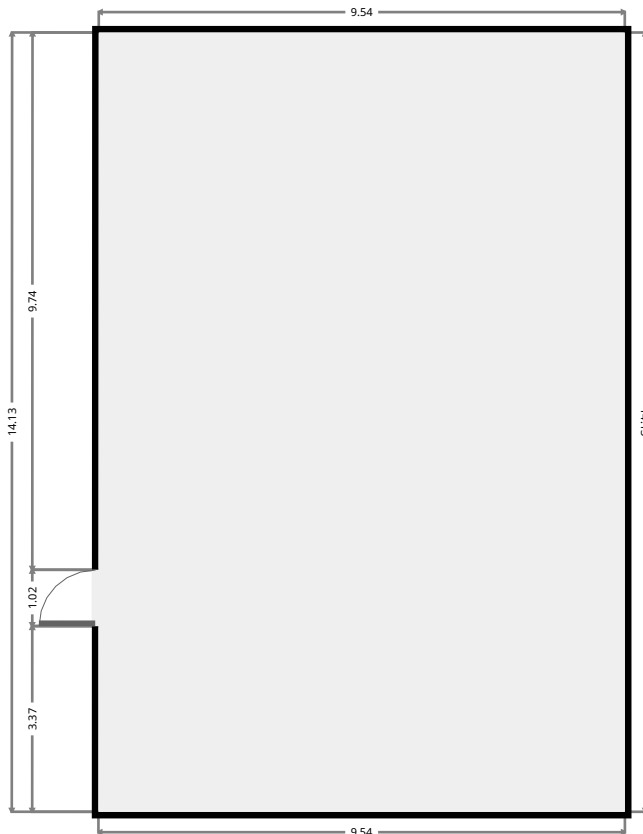
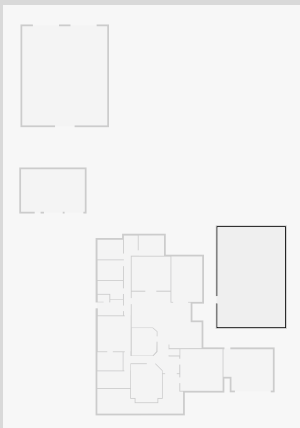

THIS FLOORPLAN IS PROVIDED WITHOUT WARRANTY OF ANY KIND. SENSOPIA DISCLAIMS ANY WARRANTY INCLUDING, WITHOUT LIMITATION, SATISFACTORY QUALITY OR ACCURACY OF DIMENSIONS.

61 Perrott Drive

Garage

Width: 5.83 m
 Length: 6.97 m
 Area: 38.43 m²
 Perimeter: 25.60 m

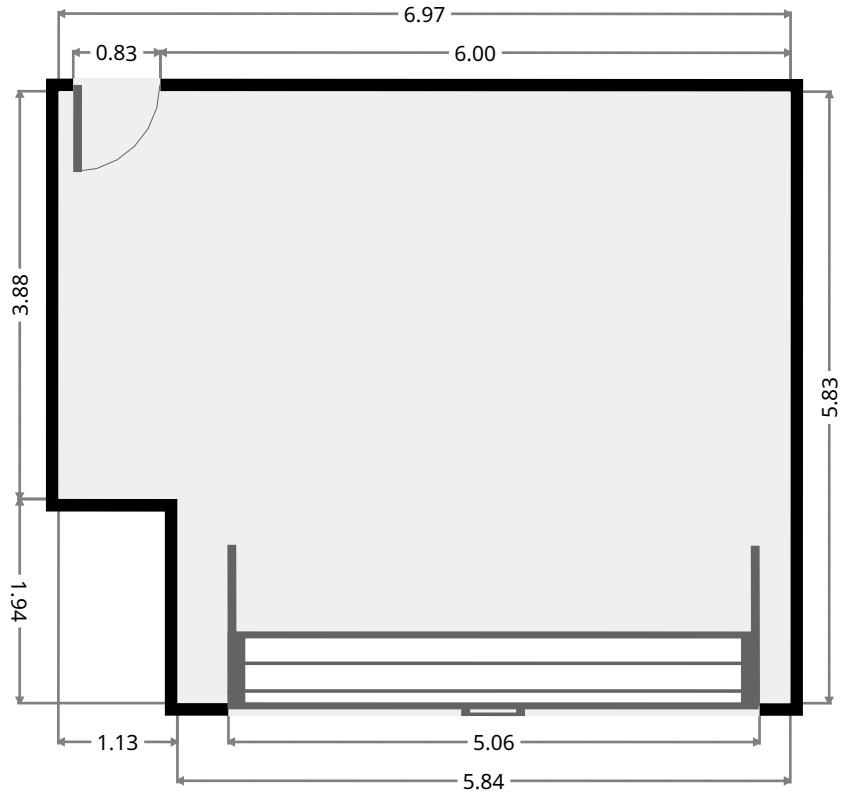
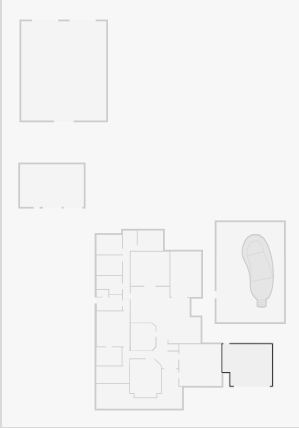

Outdoor Area

Width: 4.36 m
 Length: 6.42 m
 Area: 27.91 m²
 Perimeter: 21.53 m

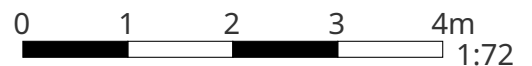
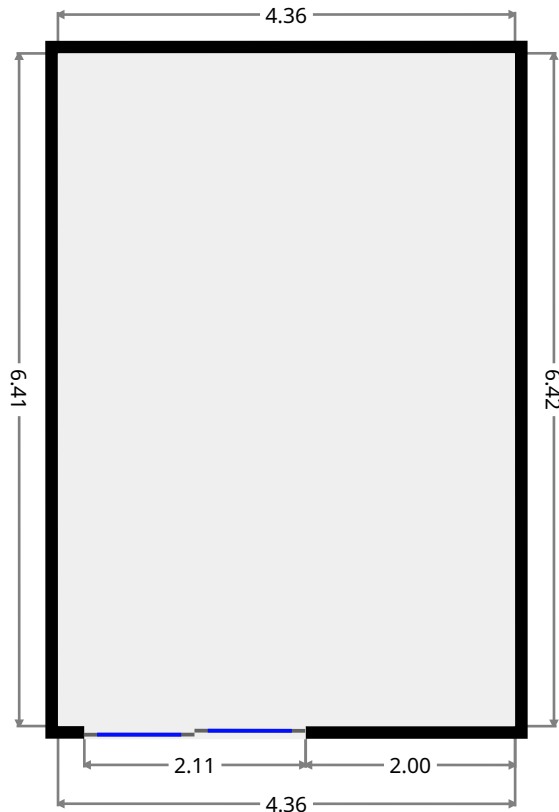
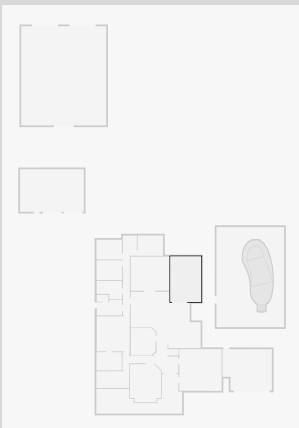

THIS FLOORPLAN IS PROVIDED WITHOUT WARRANTY OF ANY KIND. SENSOPIA DISCLAIMS ANY WARRANTY INCLUDING, WITHOUT LIMITATION, SATISFACTORY QUALITY OR ACCURACY OF DIMENSIONS.

61 Perrott Drive

Toilet

Width: 0.99 m
Length: 1.65 m
Area: 1.63 m²
Perimeter: 5.28 m

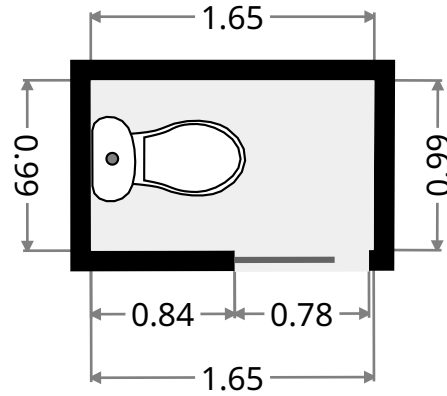
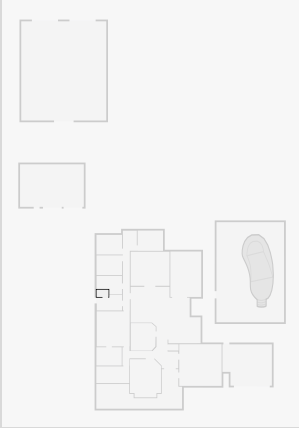

Laundry Room

Width: 2.20 m
Length: 3.56 m
Area: 7.19 m²
Perimeter: 11.51 m

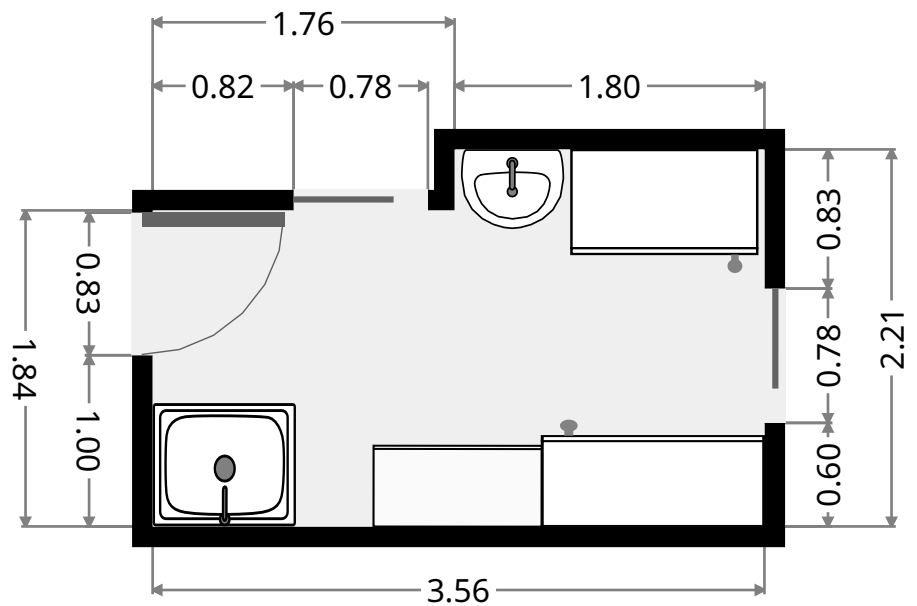
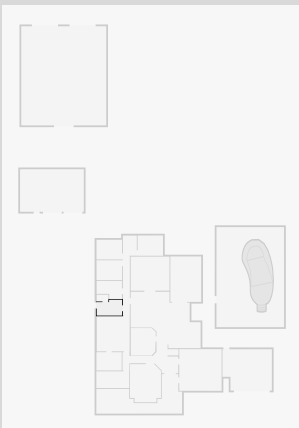

61 Perrott Drive

Bathroom

Width: 2.60 m
Length: 3.58 m
Area: 7.92 m²
Perimeter: 12.34 m

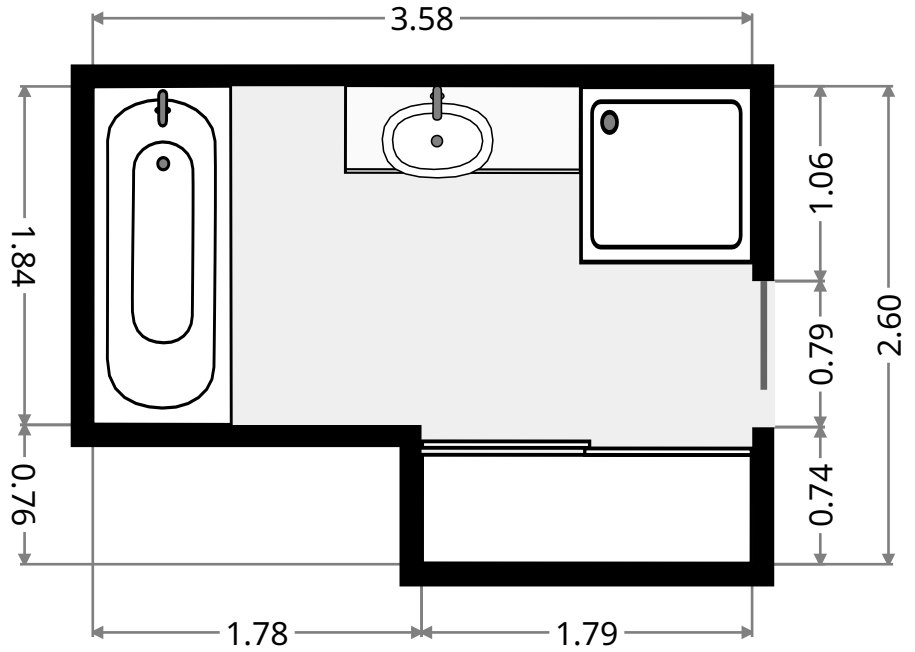
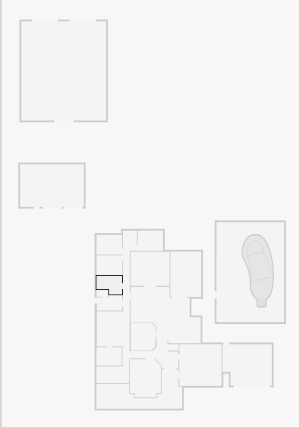

Bedroom

Width: 2.79 m
Length: 3.60 m
Area: 10.03 m²
Perimeter: 12.77 m

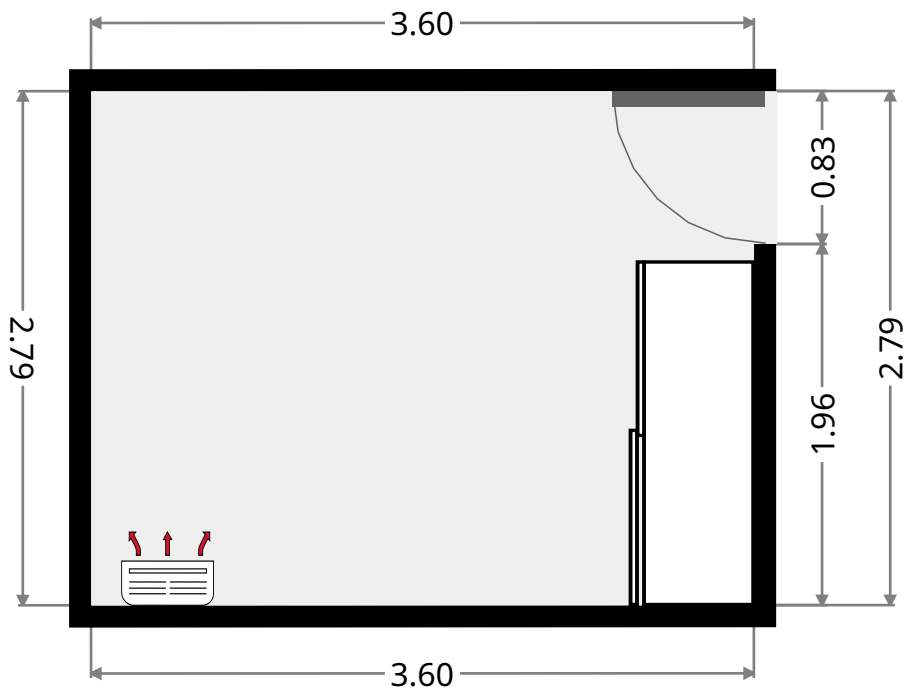
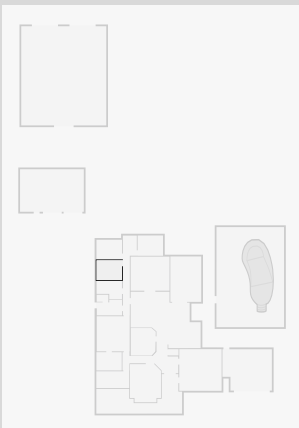

61 Perrott Drive

Bedroom

Width: 2.77 m
 Length: 3.60 m
 Area: 9.98 m²
 Perimeter: 12.75 m

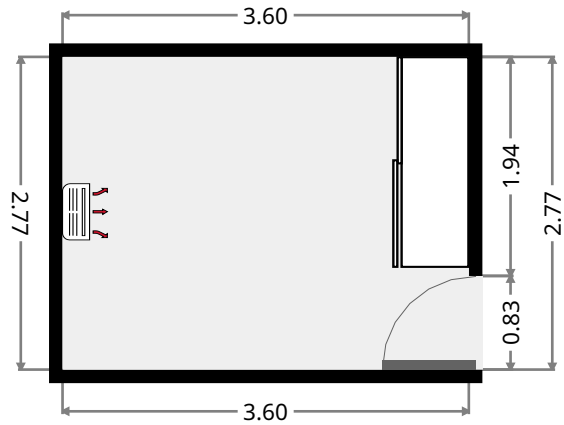

Rumpus Room

Width: 4.38 m
 Length: 5.38 m
 Area: 22.34 m²
 Perimeter: 18.97 m

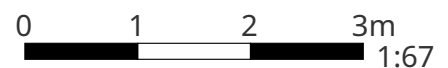
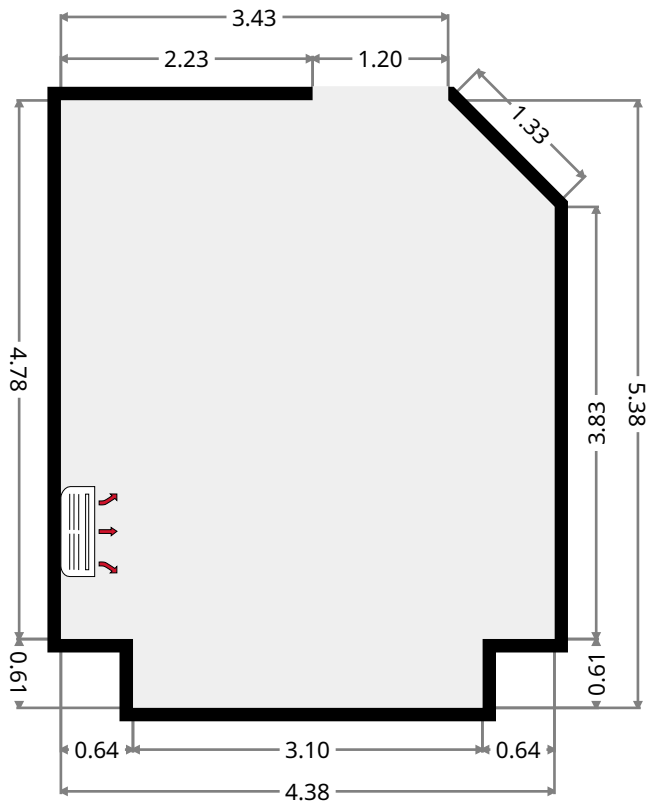
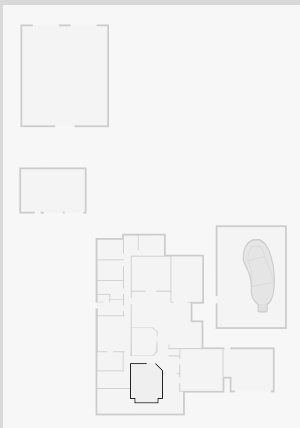

THIS FLOORPLAN IS PROVIDED WITHOUT WARRANTY OF ANY KIND. SENSOPIA DISCLAIMS ANY WARRANTY INCLUDING, WITHOUT LIMITATION, SATISFACTORY QUALITY OR ACCURACY OF DIMENSIONS.

61 Perrott Drive

Hall

Width:	1.97 m
Length:	11.27 m
Area:	13.82 m ²
Perimeter:	26.47 m

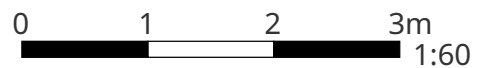
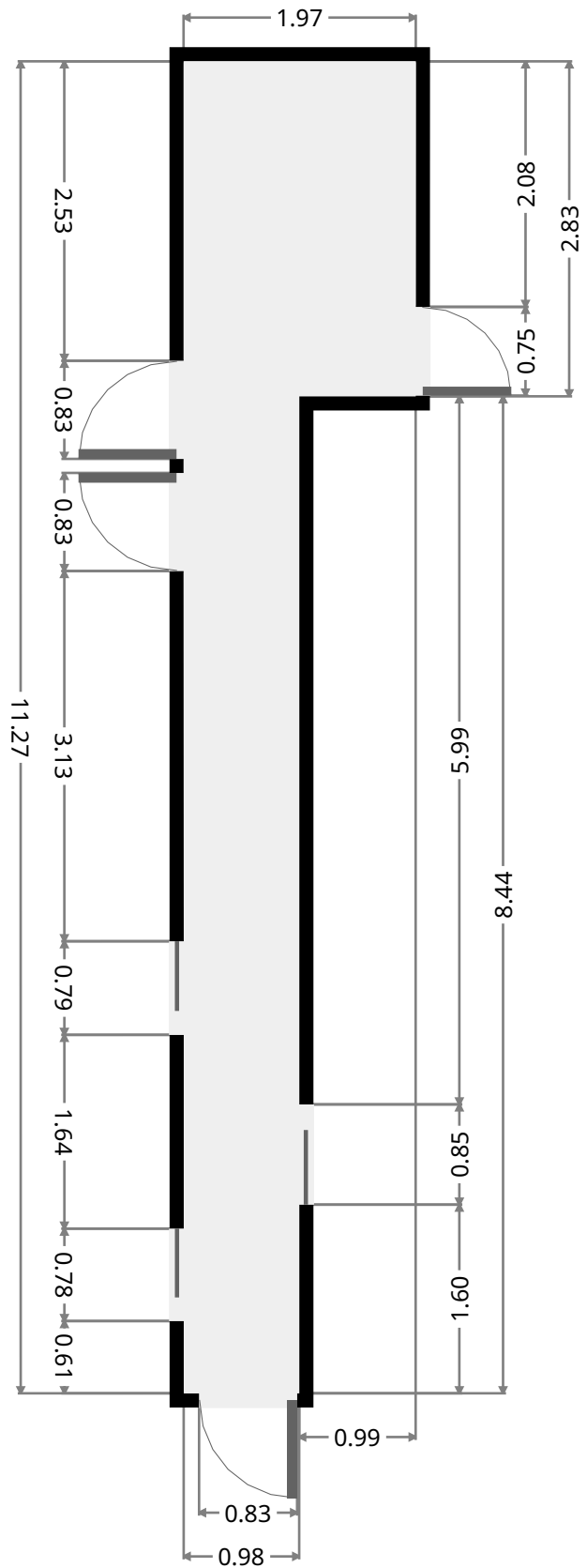
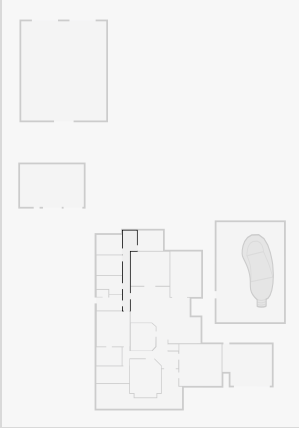

THIS FLOORPLAN IS PROVIDED WITHOUT WARRANTY OF ANY KIND. SENSOPIA DISCLAIMS ANY WARRANTY INCLUDING, WITHOUT LIMITATION, SATISFACTORY QUALITY OR ACCURACY OF DIMENSIONS.

61 Perrott Drive

Theatre Room

Width: 4.80 m
 Length: 5.49 m
 Area: 26.38 m²
 Perimeter: 20.59 m

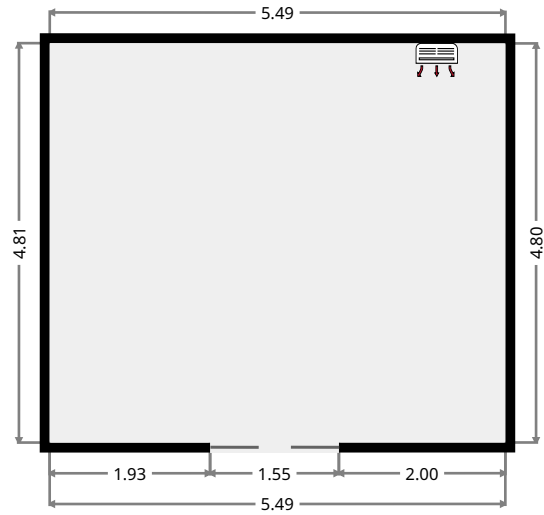
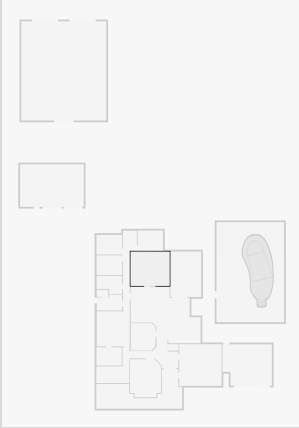

Kitchen/Living/Dining

Width: 7.97 m
 Length: 9.88 m
 Area: 56.14 m²
 Perimeter: 35.35 m

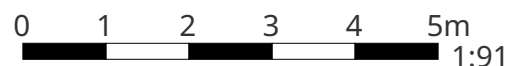
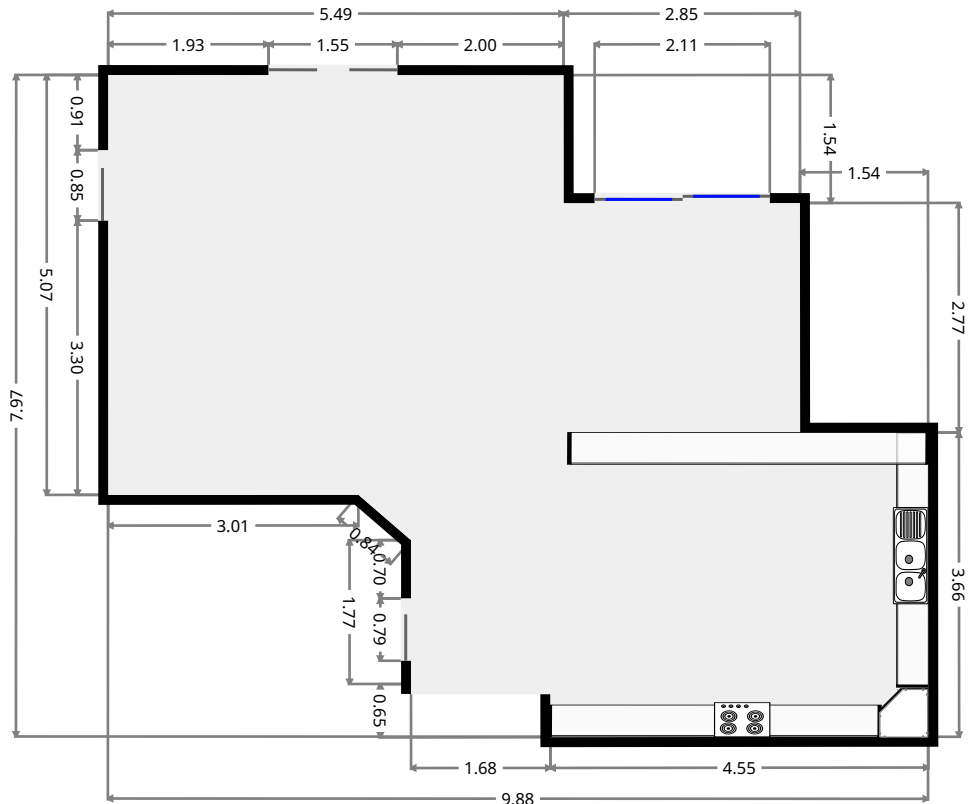
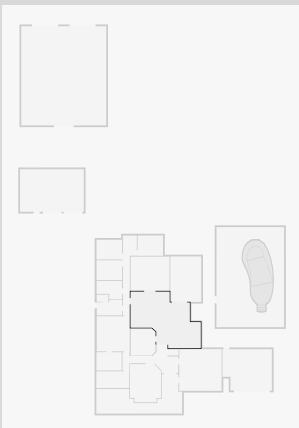

THIS FLOORPLAN IS PROVIDED WITHOUT WARRANTY OF ANY KIND. SENSOPIA DISCLAIMS ANY WARRANTY INCLUDING, WITHOUT LIMITATION, SATISFACTORY QUALITY OR ACCURACY OF DIMENSIONS.

61 Perrott Drive

Kids Treat

Width: 3.53 m
 Length: 3.89 m
 Area: 13.29 m²
 Perimeter: 14.12 m

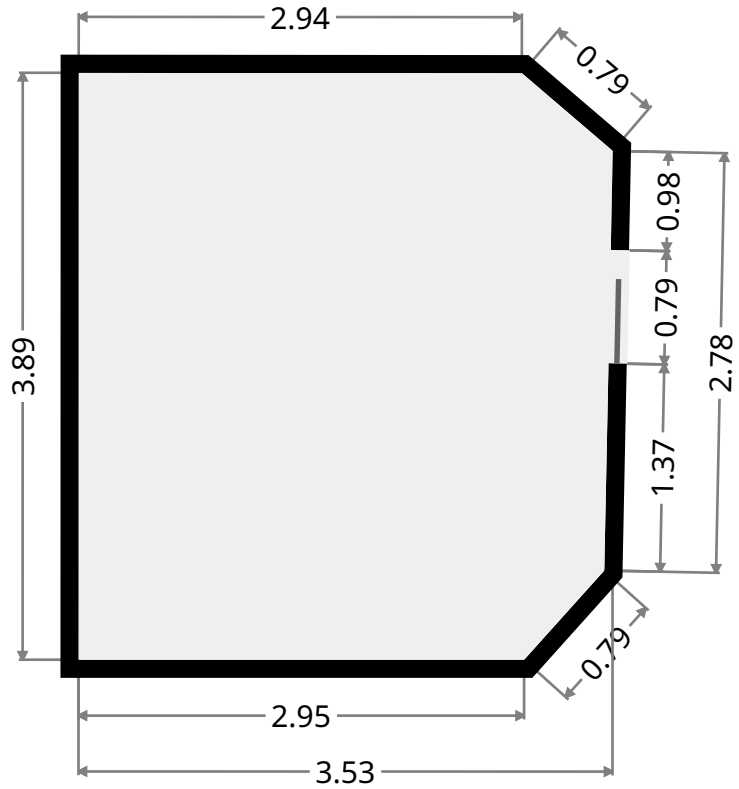
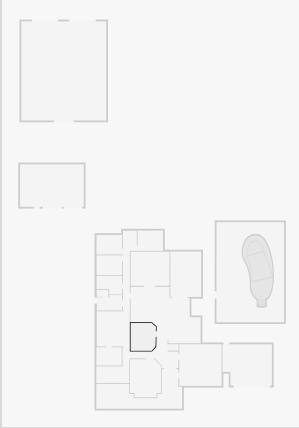

Ensuite

Width: 2.58 m
 Length: 3.57 m
 Area: 9.19 m²
 Perimeter: 12.29 m

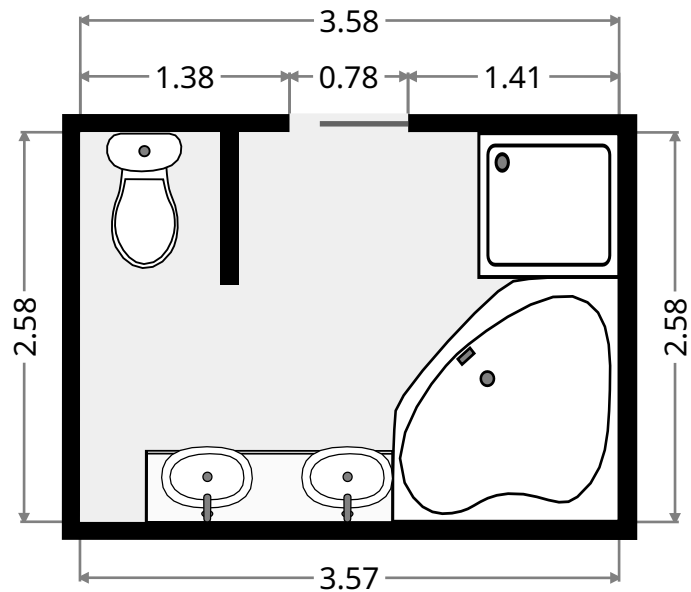
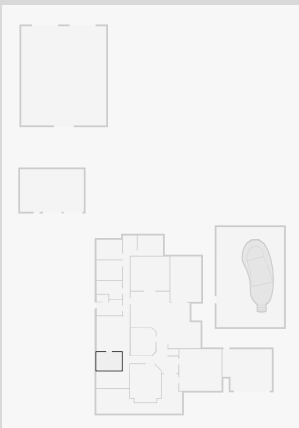

61 Perrott Drive

Master Bedroom

Width: 4.65 m
 Length: 4.96 m
 Area: 23.03 m²
 Perimeter: 19.21 m

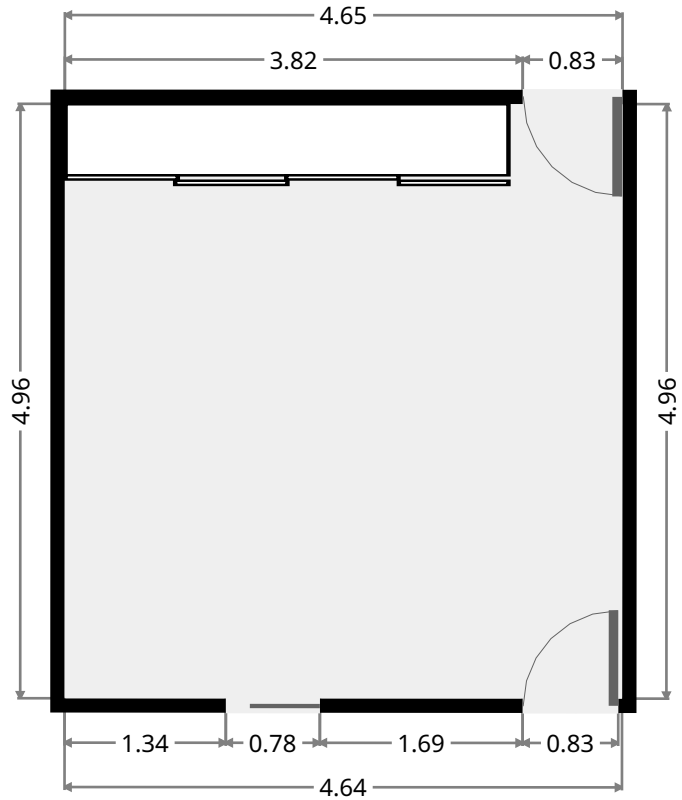
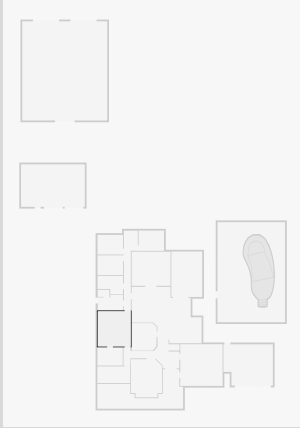

Study

Width: 2.37 m
 Length: 4.65 m
 Area: 11.02 m²
 Perimeter: 14.03 m

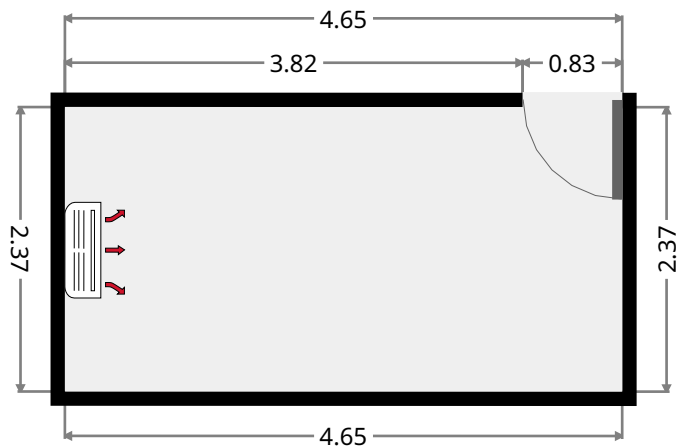
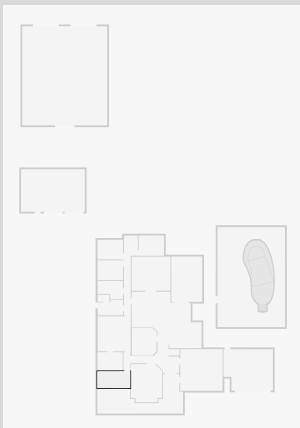

61 Perrott Drive

Closet

Width: 0.88 m
 Length: 1.45 m
 Area: 1.28 m²
 Perimeter: 4.67 m

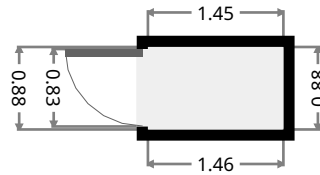
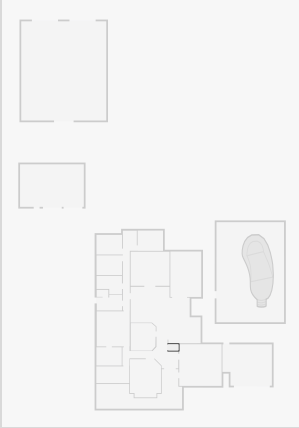

Hall

Width: 4.02 m
 Length: 7.88 m
 Area: 16.01 m²
 Perimeter: 25.97 m

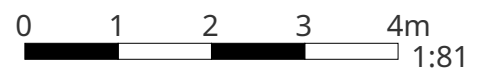
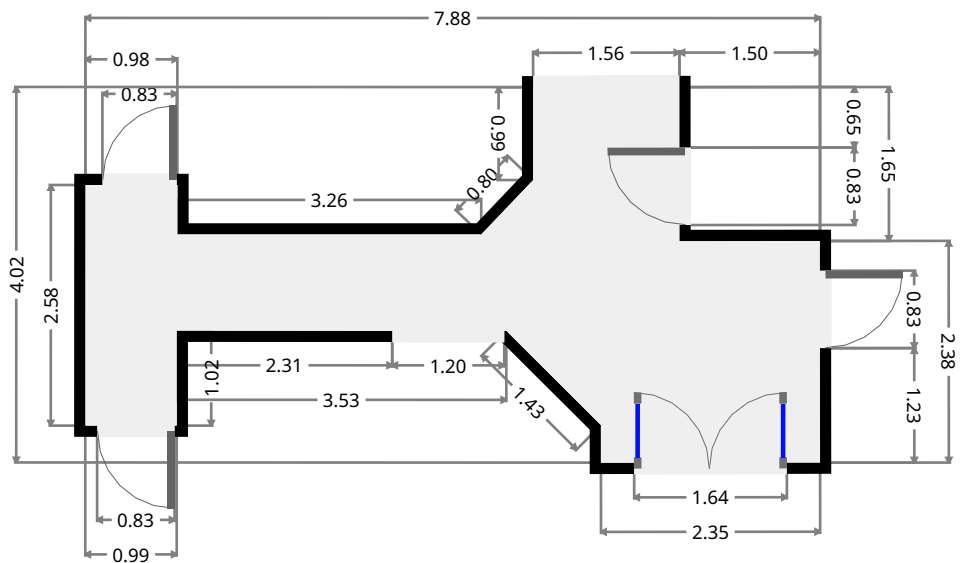
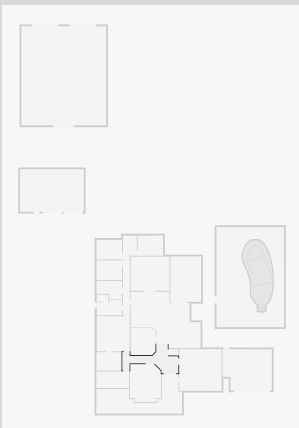

THIS FLOORPLAN IS PROVIDED WITHOUT WARRANTY OF ANY KIND. SENSOPIA DISCLAIMS ANY WARRANTY INCLUDING, WITHOUT LIMITATION, SATISFACTORY QUALITY OR ACCURACY OF DIMENSIONS.

61 Perrott Drive

Media Room

Width: 5.88 m
Length: 5.98 m
Area: 35.13 m²
Perimeter: 23.71 m

