

5 Poole Street

Ground Floor

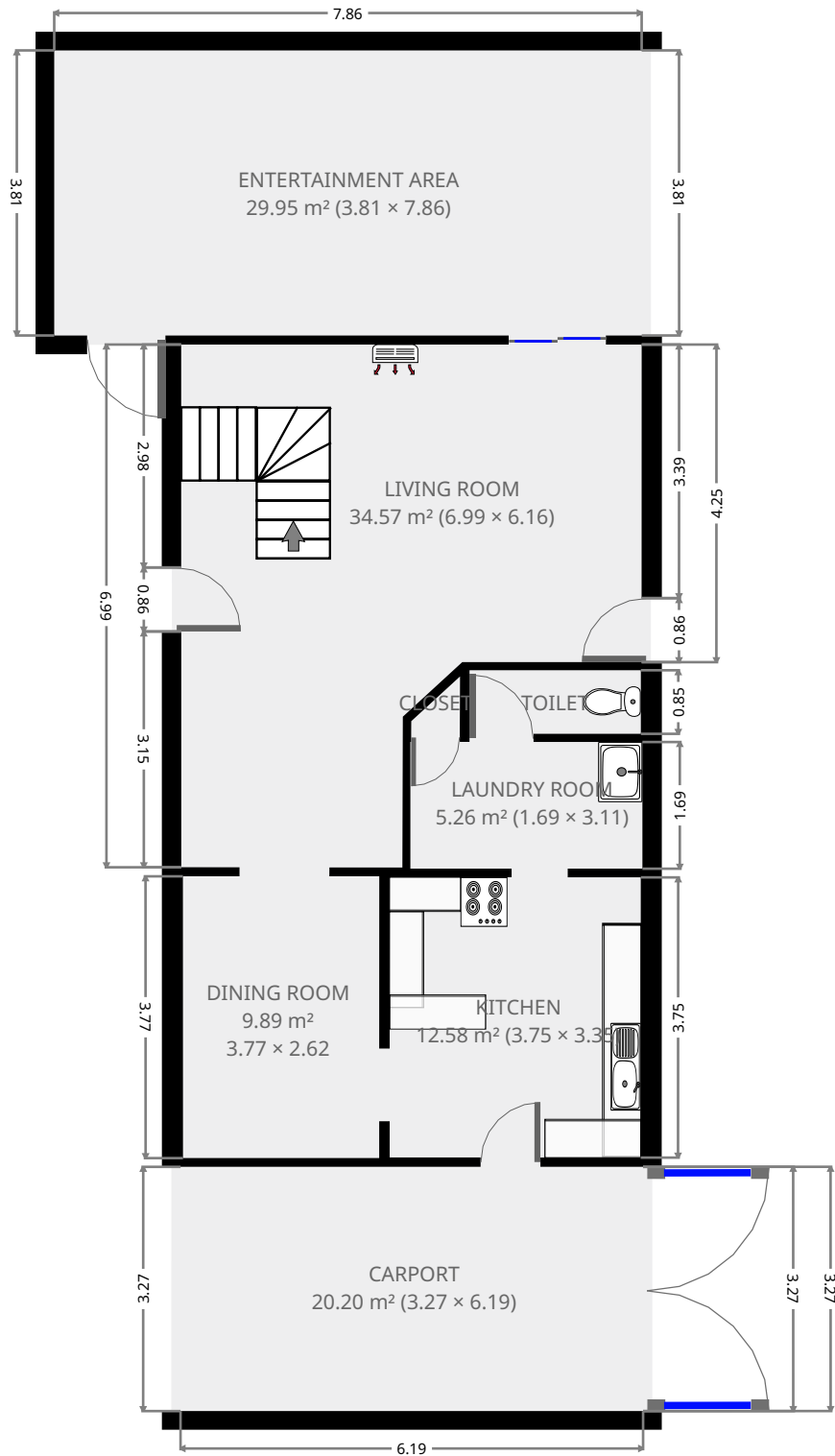

THIS FLOORPLAN IS PROVIDED WITHOUT WARRANTY OF ANY KIND. SENSOPIA DISCLAIMS ANY WARRANTY INCLUDING, WITHOUT LIMITATION, SATISFACTORY QUALITY OR ACCURACY OF DIMENSIONS.



5 Poole Street

Living Room

Width: 6.16 m
 Length: 6.99 m
 Area: 34.57 m²
 Perimeter: 25.85 m

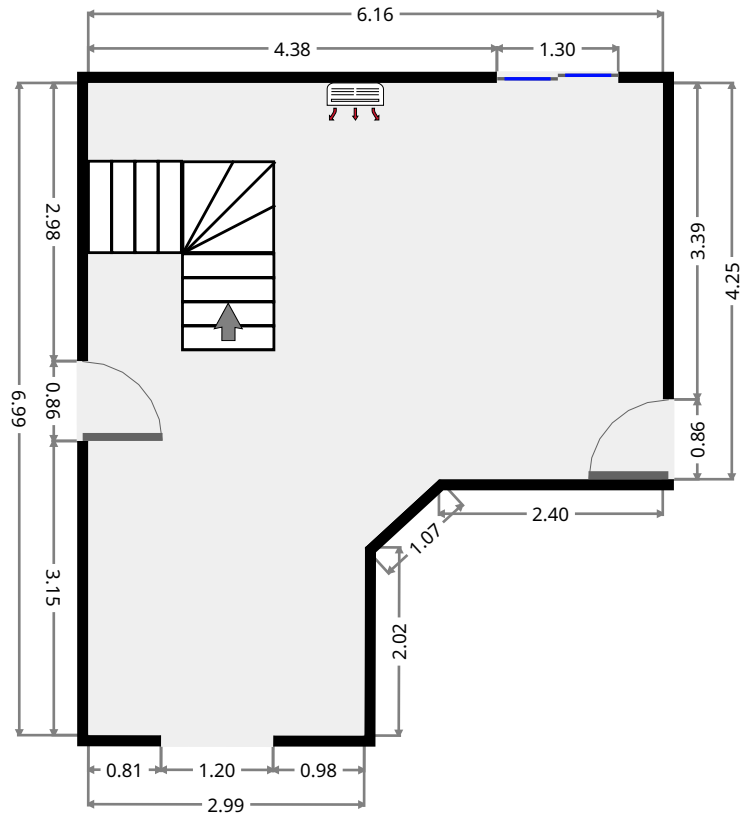
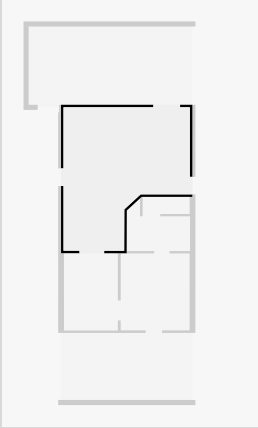

Dining Room

Width: 2.62 m
 Length: 3.77 m
 Area: 9.89 m²
 Perimeter: 12.79 m

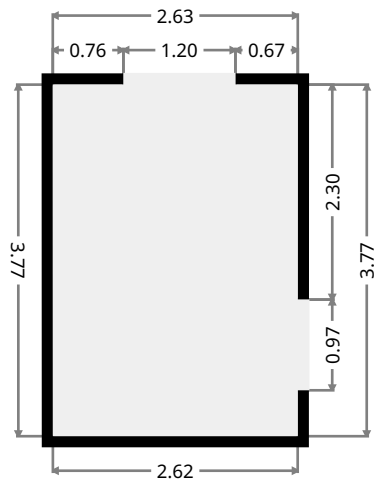
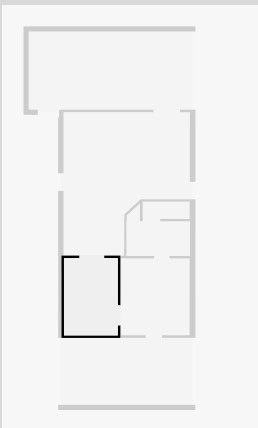

5 Poole Street

Kitchen

Width: 3.35 m
 Length: 3.75 m
 Area: 12.58 m²
 Perimeter: 14.21 m

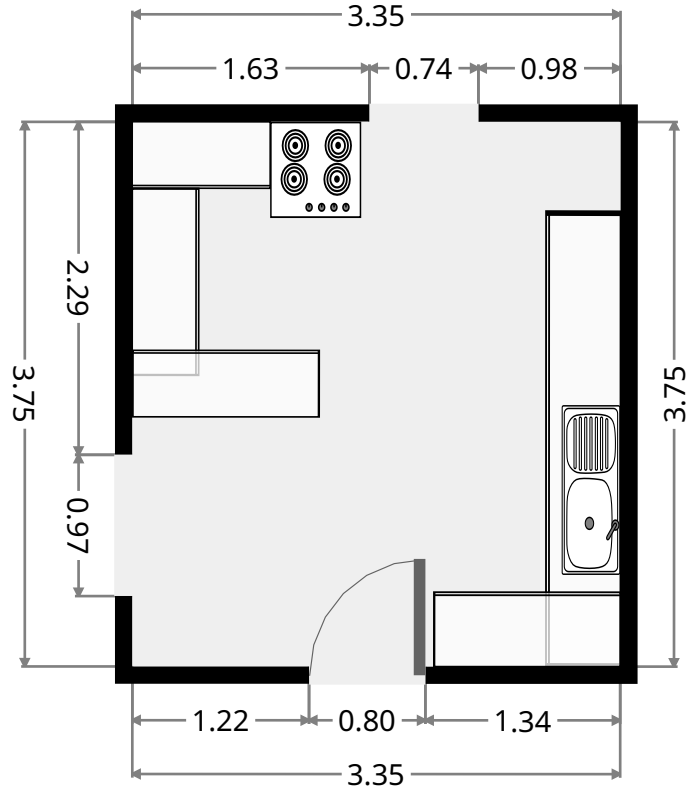
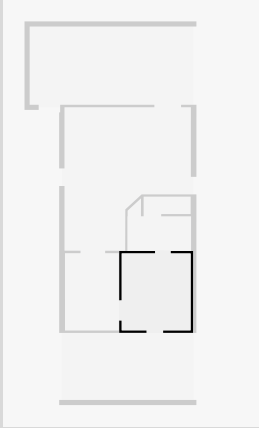

Toilet

Width: 0.85 m
 Length: 2.29 m
 Area: 1.95 m²
 Perimeter: 6.28 m

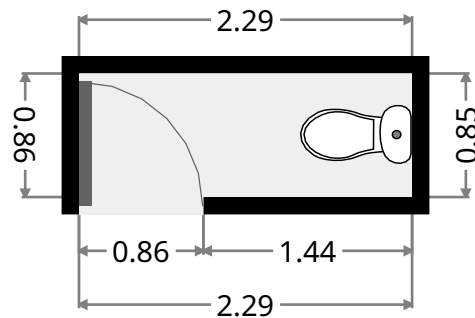
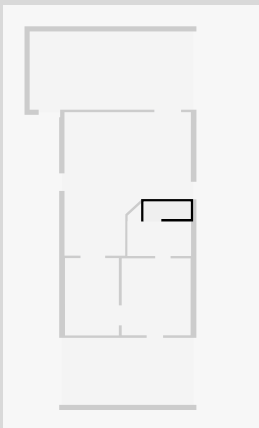

5 Poole Street

Laundry Room

Width: 1.69 m
Length: 3.11 m
Area: 5.26 m²
Perimeter: 9.60 m

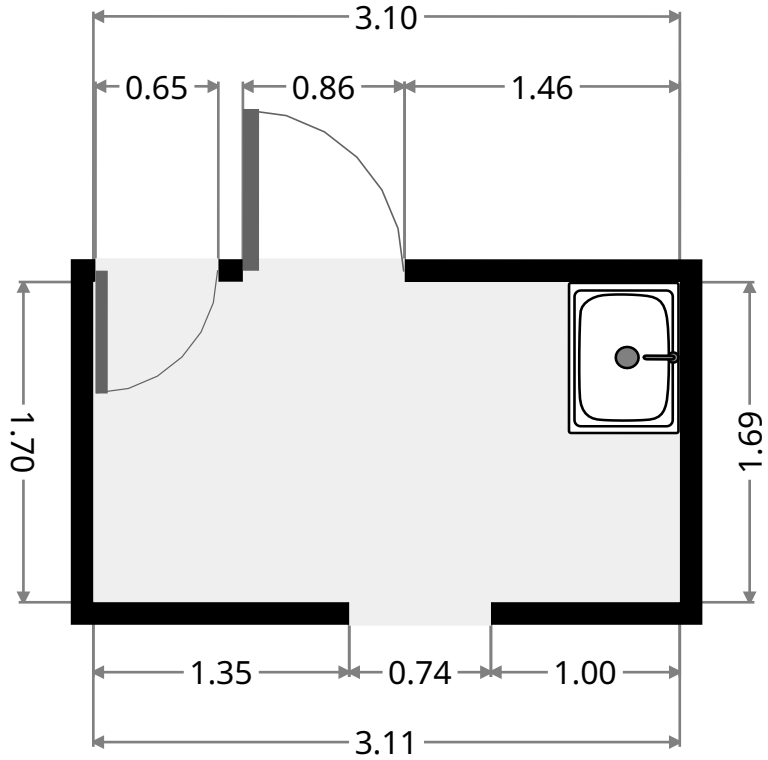
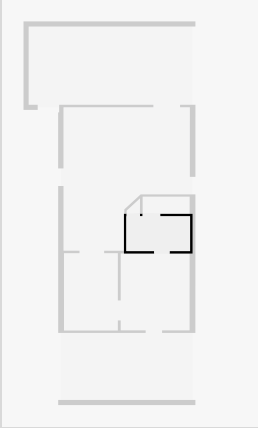

Closet

Width: 0.56 m
Length: 0.88 m
Area: 0.30 m²
Perimeter: 2.45 m

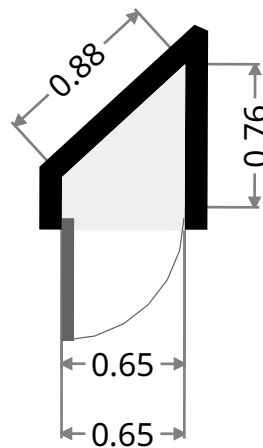
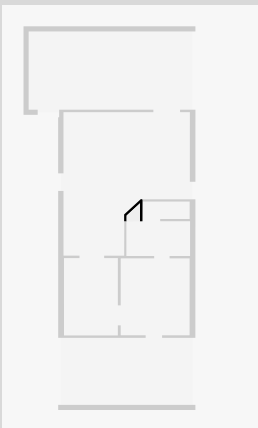

5 Poole Street

Carport

Width: 3.27 m
 Length: 6.19 m
 Area: 20.20 m²
 Perimeter: 18.90 m

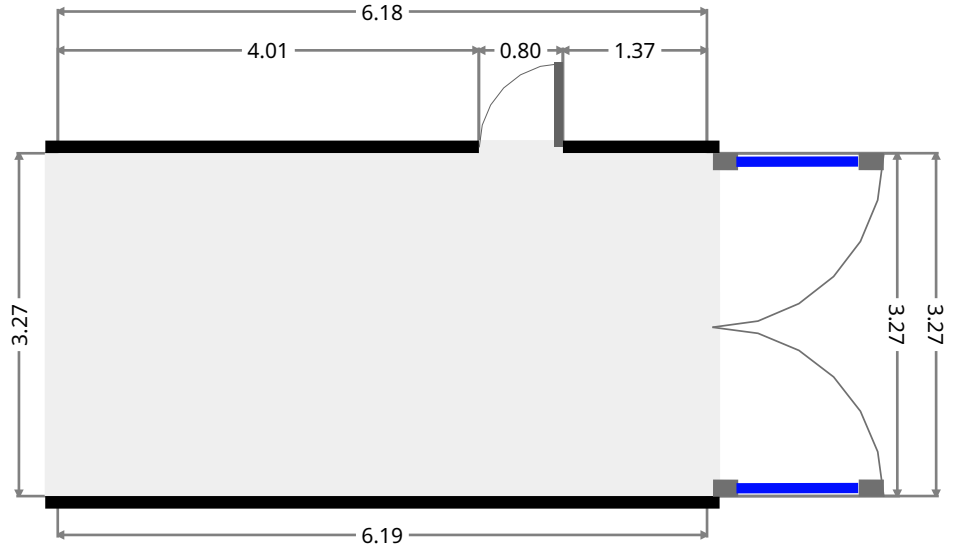

Entertainment Area

Width: 3.81 m
 Length: 7.86 m
 Area: 29.95 m²
 Perimeter: 23.34 m

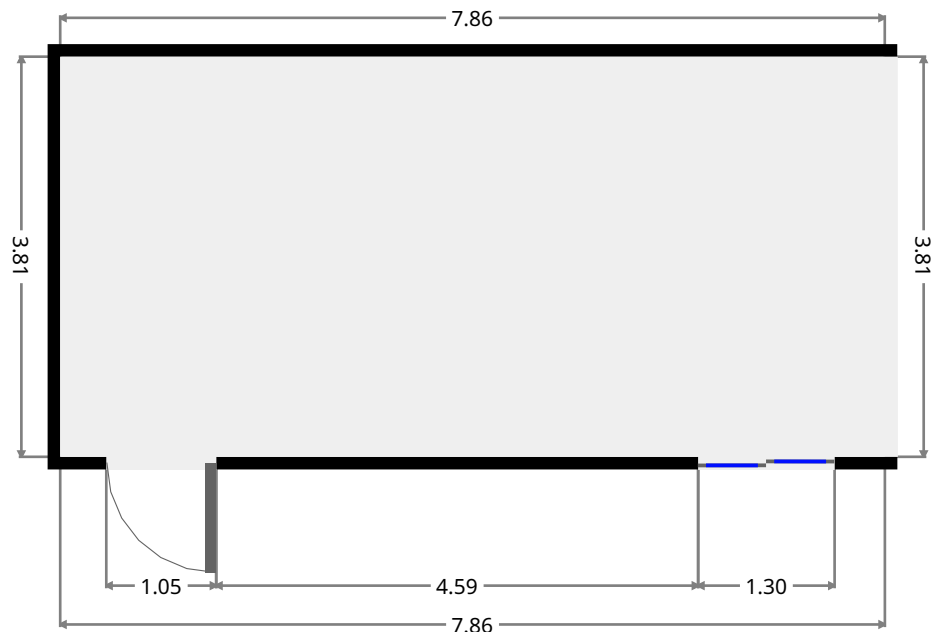
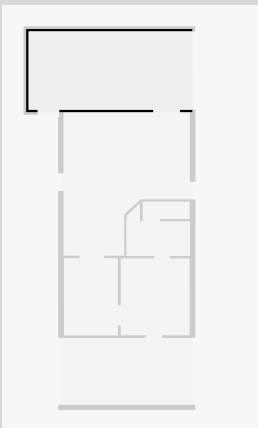

THIS FLOORPLAN IS PROVIDED WITHOUT WARRANTY OF ANY KIND. SENSOPIA DISCLAIMS ANY WARRANTY INCLUDING, WITHOUT LIMITATION, SATISFACTORY QUALITY OR ACCURACY OF DIMENSIONS.

5 Poole Street

1st Floor

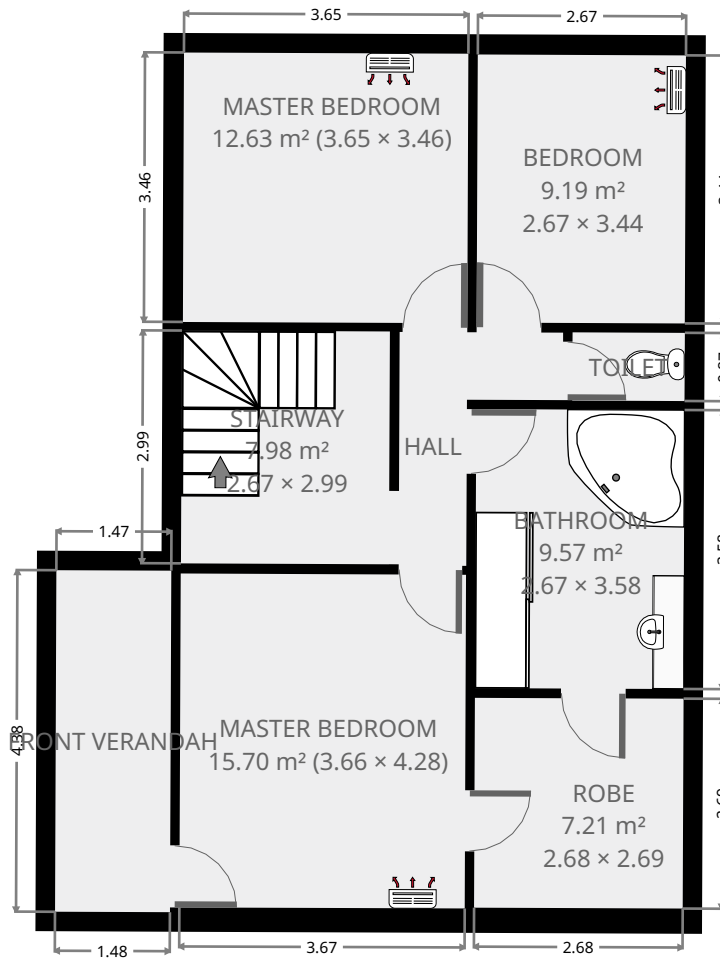

THIS FLOORPLAN IS PROVIDED WITHOUT WARRANTY OF ANY KIND. SENSOPIA DISCLAIMS ANY WARRANTY INCLUDING, WITHOUT LIMITATION, SATISFACTORY QUALITY OR ACCURACY OF DIMENSIONS.

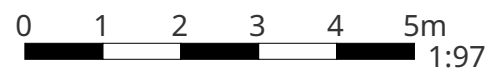

5 Poole Street

Master Bedroom

Width: 3.66 m
 Length: 4.28 m
 Area: 15.70 m²
 Perimeter: 15.90 m

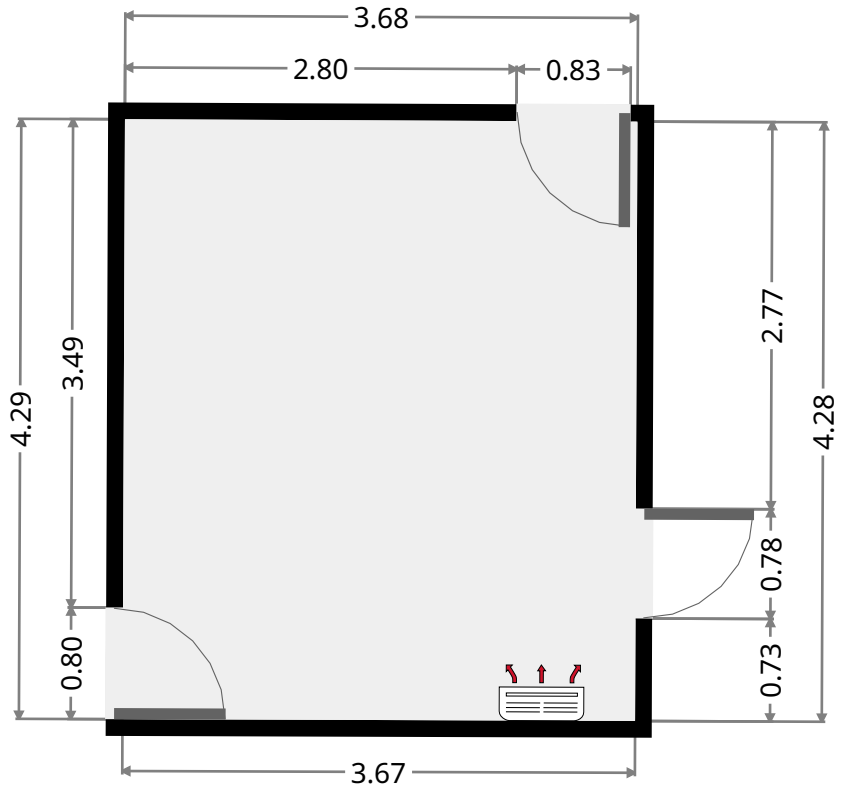
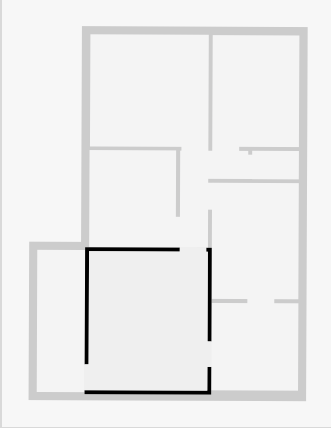

Robe

Width: 2.68 m
 Length: 2.69 m
 Area: 7.21 m²
 Perimeter: 10.74 m

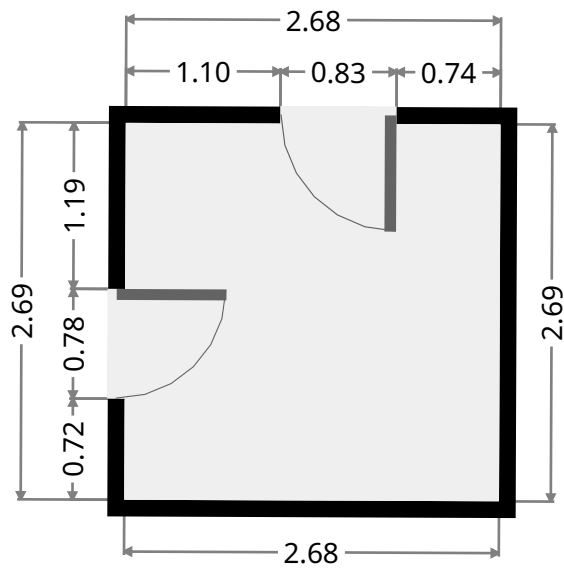
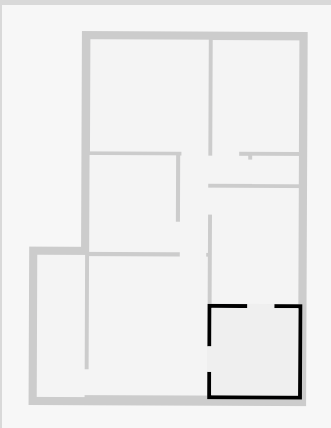

5 Poole Street

Bathroom

Width: 2.67 m
 Length: 3.58 m
 Area: 9.57 m²
 Perimeter: 12.51 m

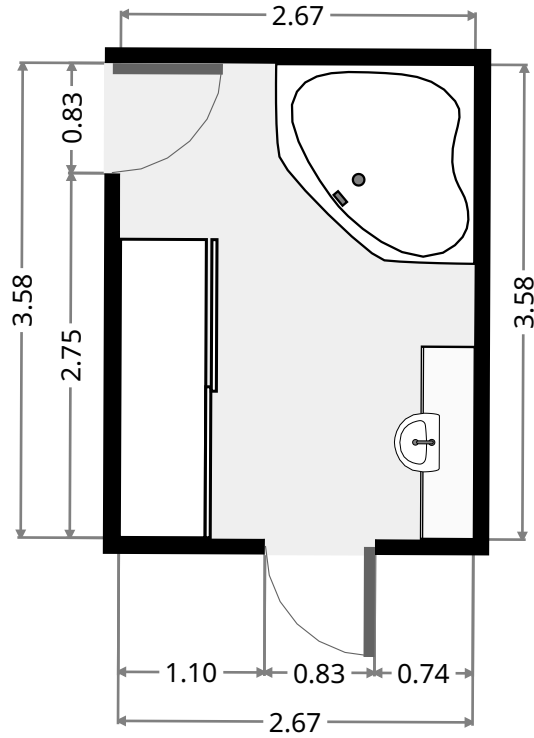
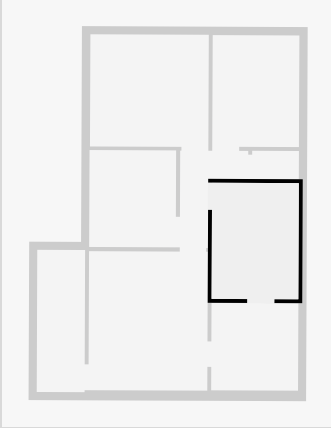

Hall

Width: 2.10 m
 Length: 3.00 m
 Area: 3.67 m²
 Perimeter: 10.19 m

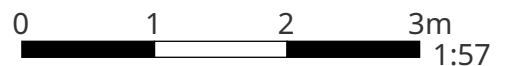
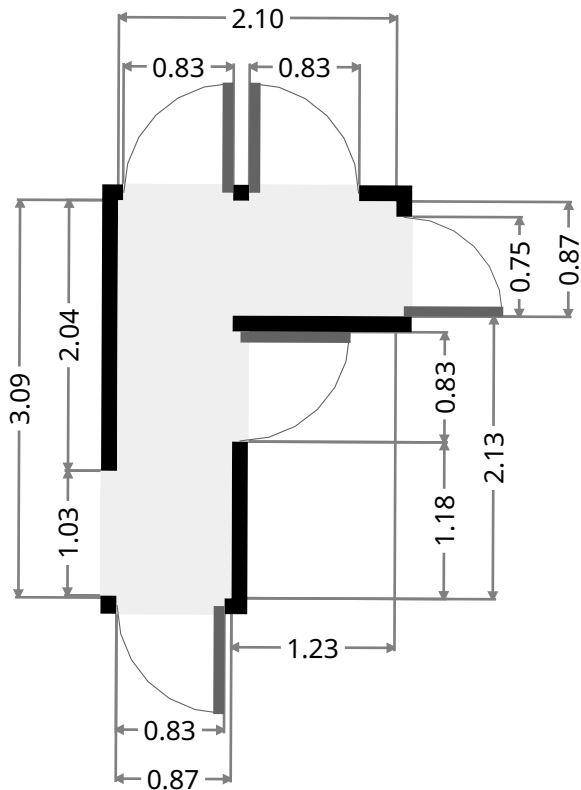
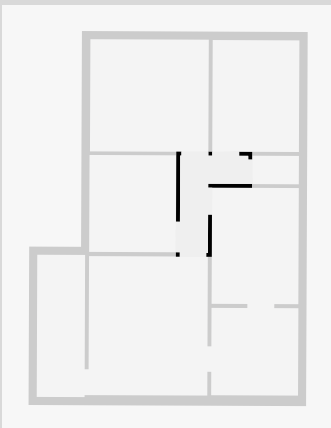

THIS FLOORPLAN IS PROVIDED WITHOUT WARRANTY OF ANY KIND. SENSOPIA DISCLAIMS ANY WARRANTY INCLUDING, WITHOUT LIMITATION, SATISFACTORY QUALITY OR ACCURACY OF DIMENSIONS.

5 Poole Street

Stairway

Width: 2.67 m
 Length: 2.99 m
 Area: 7.98 m²
 Perimeter: 11.32 m

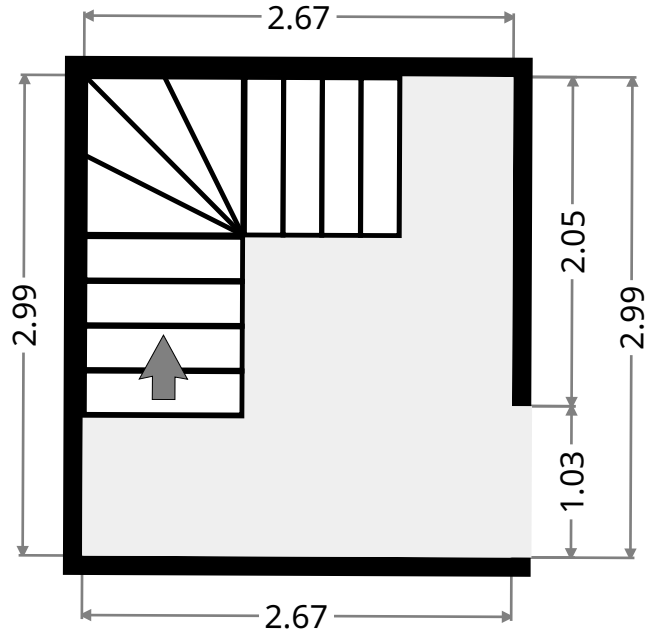
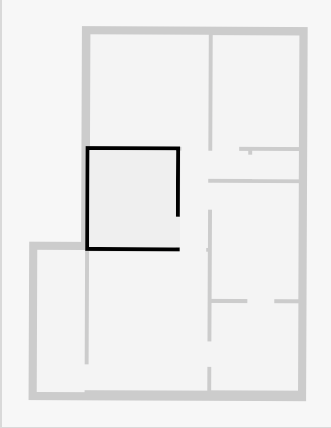

Master Bedroom

Width: 3.46 m
 Length: 3.65 m
 Area: 12.63 m²
 Perimeter: 14.22 m

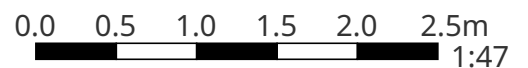
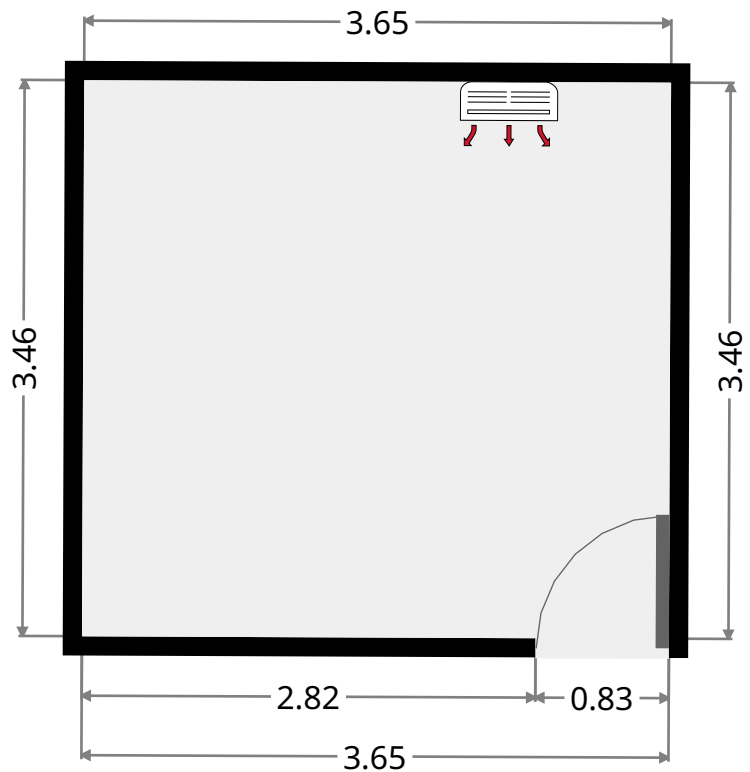
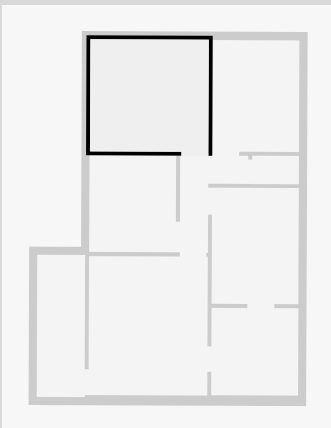

THIS FLOORPLAN IS PROVIDED WITHOUT WARRANTY OF ANY KIND. SENSOPIA DISCLAIMS ANY WARRANTY INCLUDING, WITHOUT LIMITATION, SATISFACTORY QUALITY OR ACCURACY OF DIMENSIONS.

5 Poole Street

Bedroom

Width: 2.67 m
Length: 3.44 m
Area: 9.19 m²
Perimeter: 12.22 m

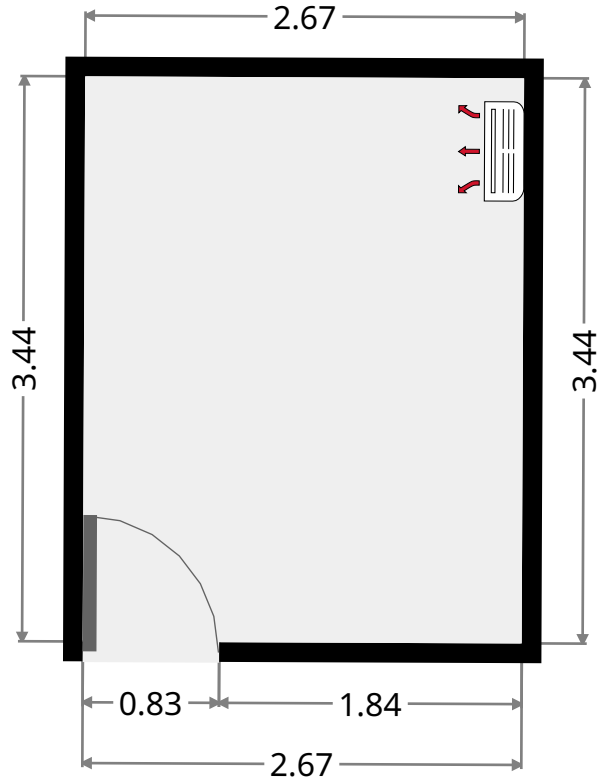
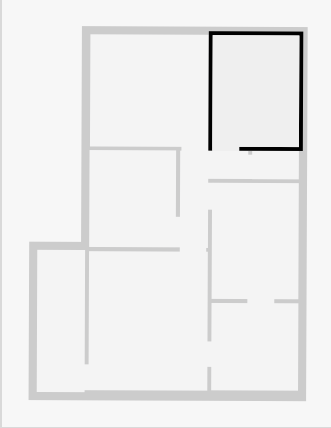

Toilet

Width: 0.87 m
Length: 1.44 m
Area: 1.26 m²
Perimeter: 4.63 m

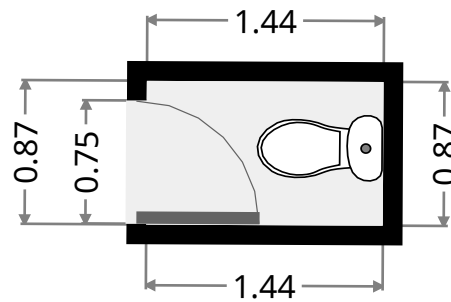
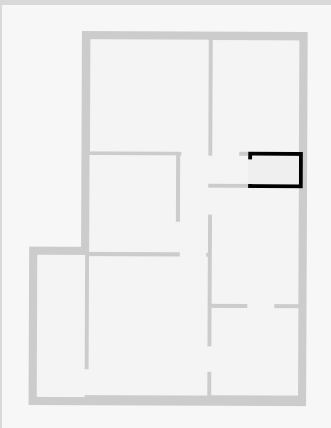

5 Poole Street

Front Verandah

Width: 1.47 m
Length: 4.39 m
Area: 6.47 m²
Perimeter: 11.72 m

