

45 Fons Drive

Ground Floor

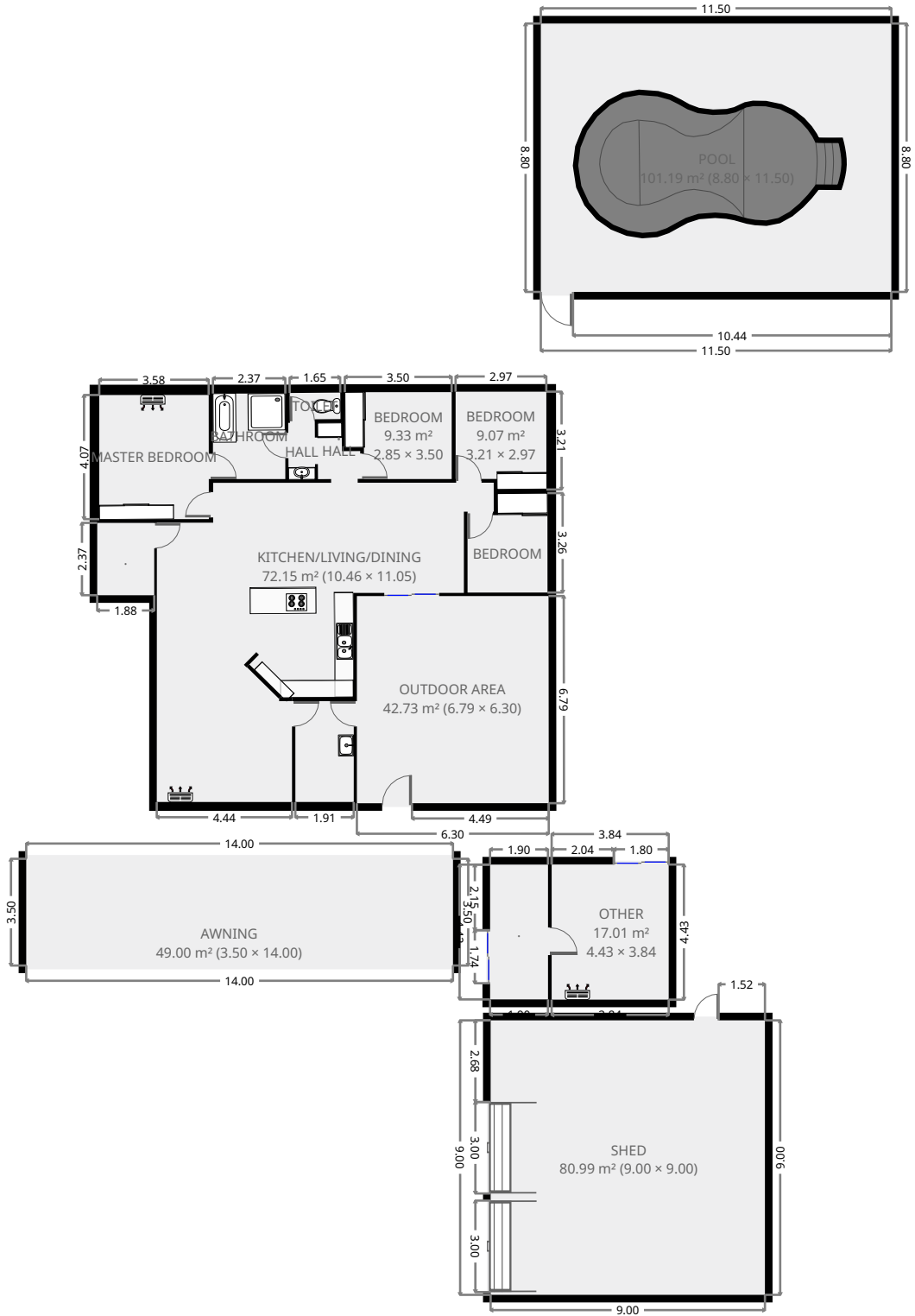

THIS FLOORPLAN IS PROVIDED WITHOUT WARRANTY OF ANY KIND. SENSOPIA DISCLAIMS ANY WARRANTY INCLUDING, WITHOUT LIMITATION, SATISFACTORY QUALITY OR ACCURACY OF DIMENSIONS.



45 Fons Drive

Bedroom

Width: 2.97 m
Length: 3.21 m
Area: 9.07 m²
Perimeter: 12.37 m

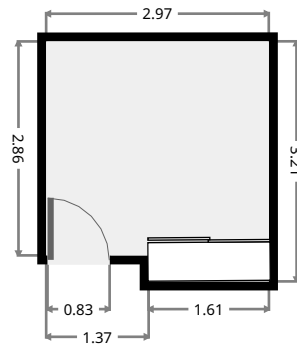
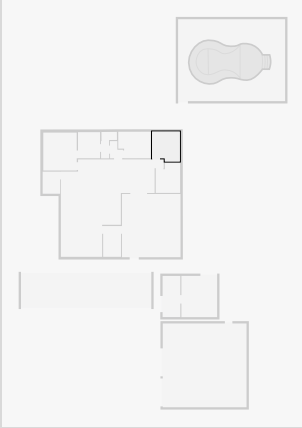

Pool

Width: 8.80 m
Length: 11.50 m
Area: 101.19 m²
Perimeter: 40.60 m

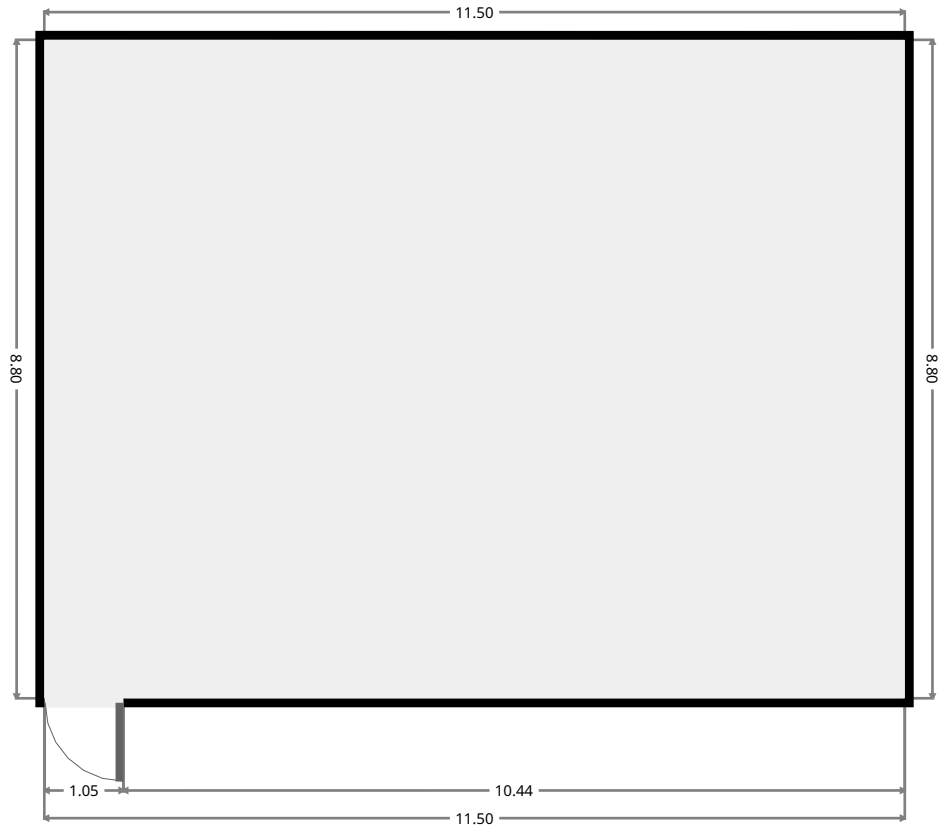
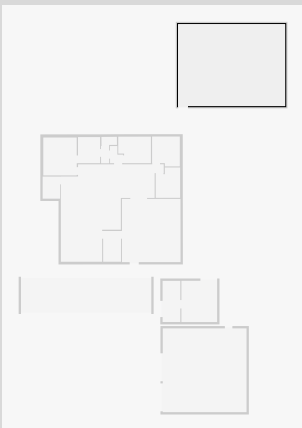

45 Fons Drive

Awning

Width: 3.50 m
Length: 14.00 m
Area: 49.00 m²
Perimeter: 35.00 m

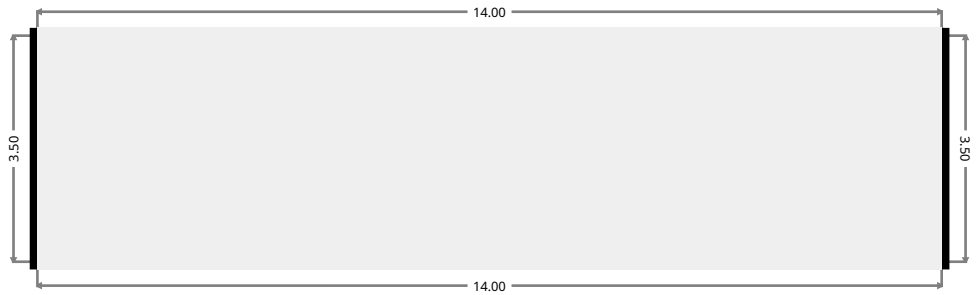
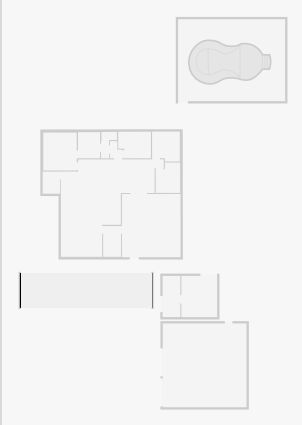

45 Fons Drive

Shed

Width: 9.00 m
 Length: 9.00 m
 Area: 80.99 m²
 Perimeter: 36.00 m

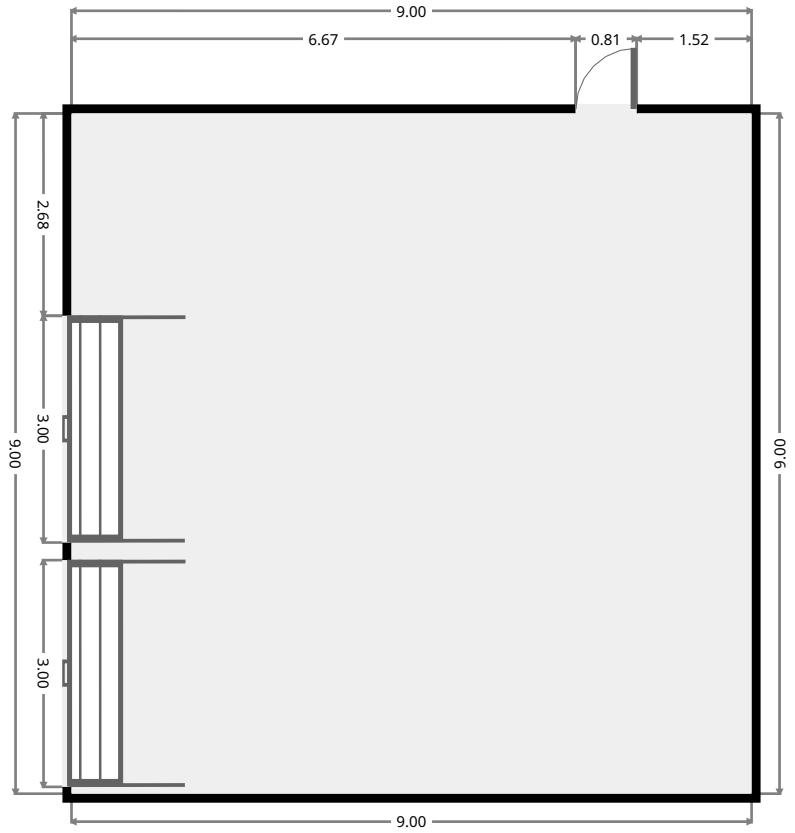
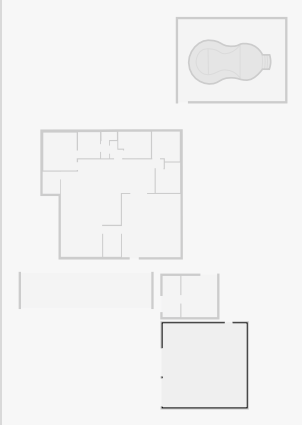

• Width: 1.90 m
 Length: 4.42 m
 Area: 8.40 m²
 Perimeter: 12.64 m

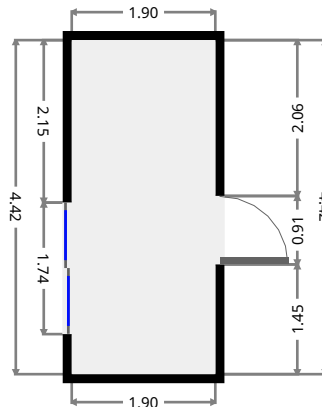
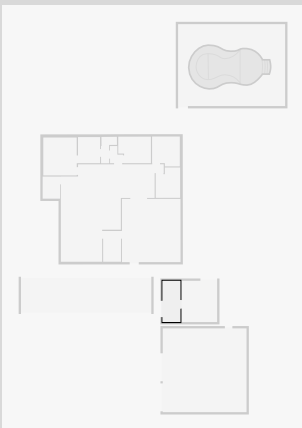

THIS FLOORPLAN IS PROVIDED WITHOUT WARRANTY OF ANY KIND. SENSOPIA DISCLAIMS ANY WARRANTY INCLUDING, WITHOUT LIMITATION, SATISFACTORY QUALITY OR ACCURACY OF DIMENSIONS.



45 Fons Drive

Other

Width: 3.84 m
 Length: 4.43 m
 Area: 17.01 m²
 Perimeter: 16.54 m

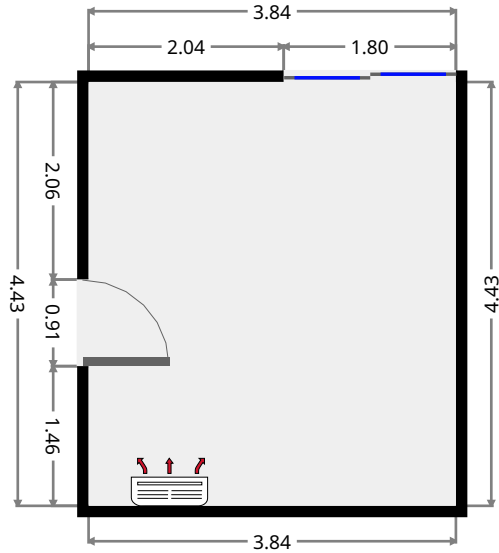
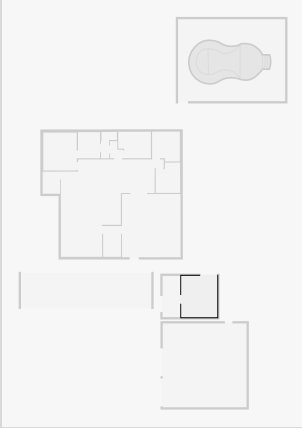

Outdoor Area

Width: 6.30 m
 Length: 6.79 m
 Area: 42.73 m²
 Perimeter: 26.17 m

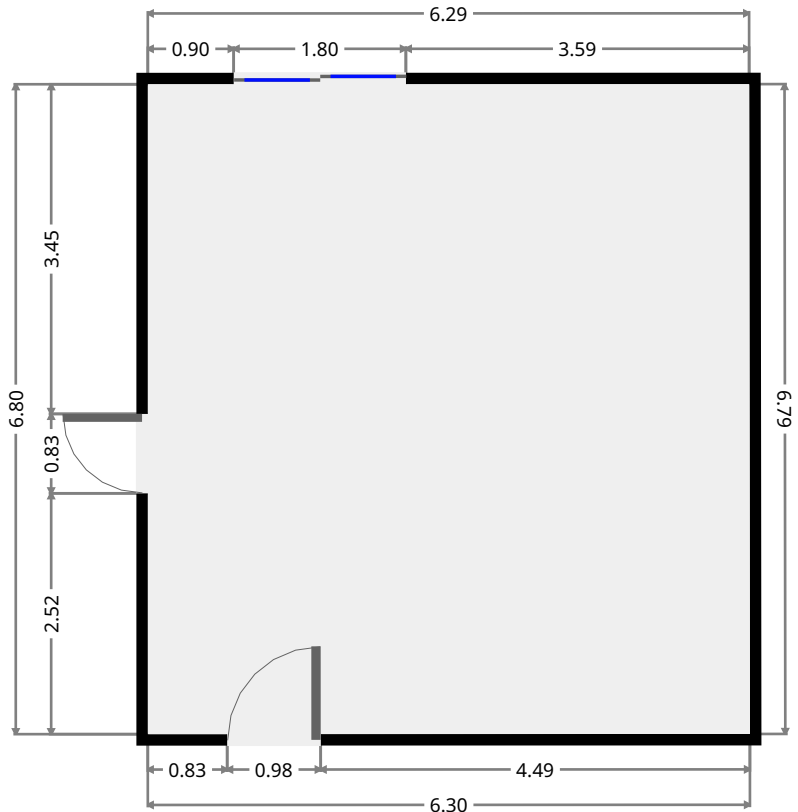
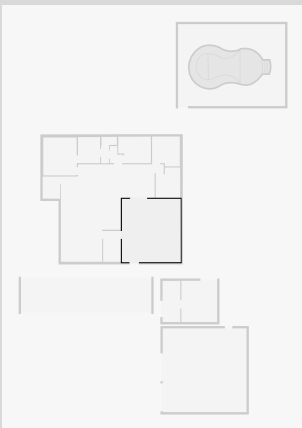

THIS FLOORPLAN IS PROVIDED WITHOUT WARRANTY OF ANY KIND. SENSOPIA DISCLAIMS ANY WARRANTY INCLUDING, WITHOUT LIMITATION, SATISFACTORY QUALITY OR ACCURACY OF DIMENSIONS.

45 Fons Drive

•
 Width: 1.88 m
 Length: 2.37 m
 Area: 4.43 m²
 Perimeter: 8.48 m

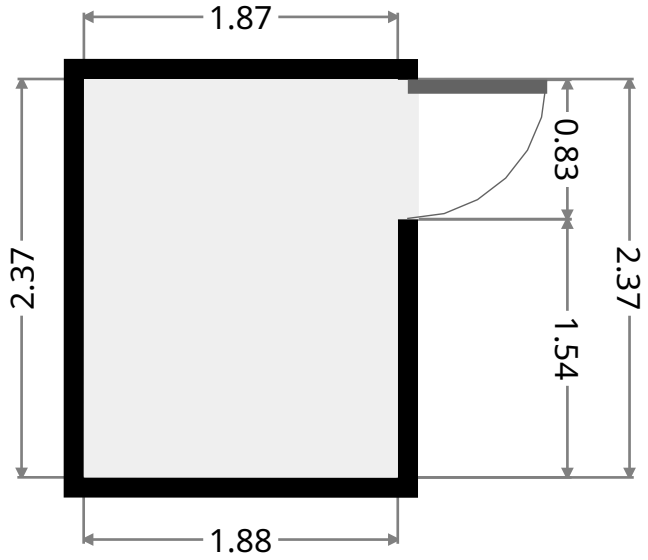
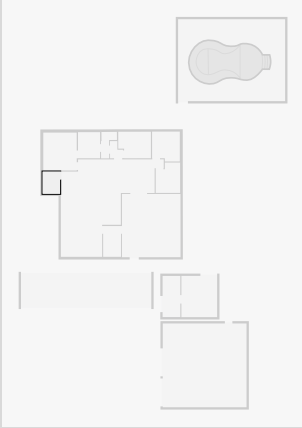

Bedroom

Width: 2.62 m
 Length: 3.26 m
 Area: 7.84 m²
 Perimeter: 11.76 m

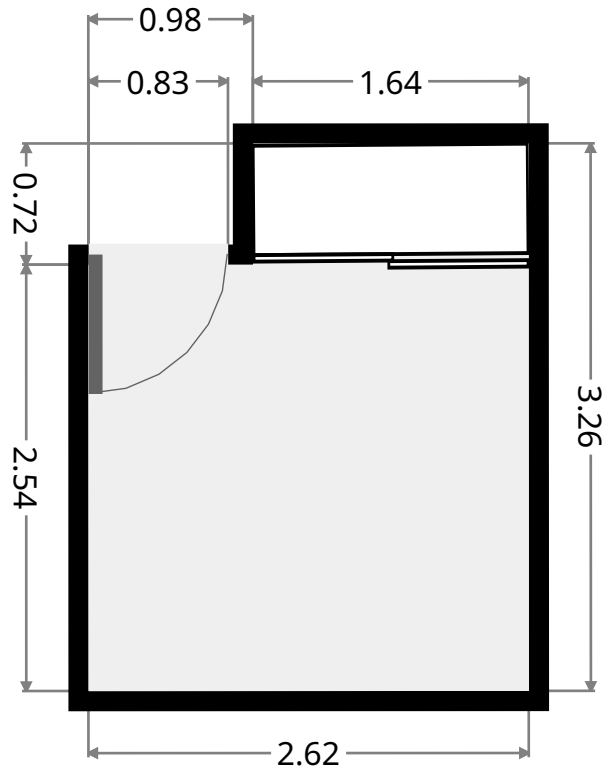
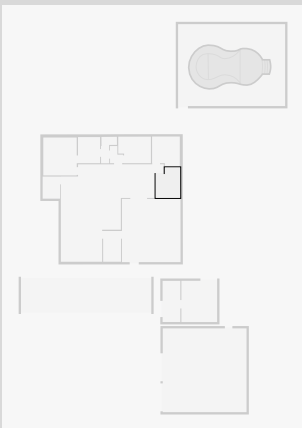

45 Fons Drive

Bedroom

Width: 2.85 m
 Length: 3.50 m
 Area: 9.33 m²
 Perimeter: 12.70 m

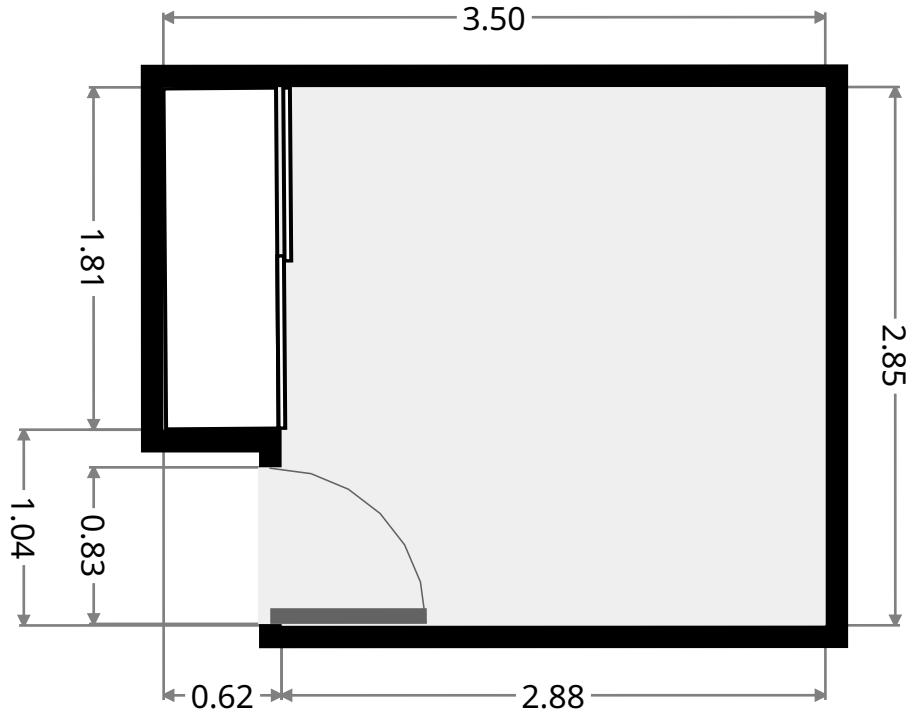
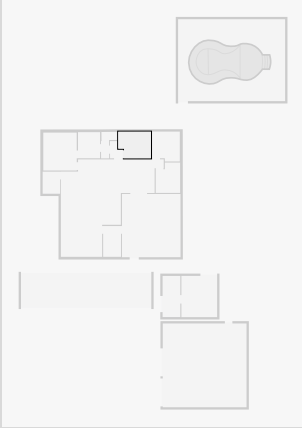

Bathroom

Width: 2.37 m
 Length: 2.80 m
 Area: 6.65 m²
 Perimeter: 10.35 m

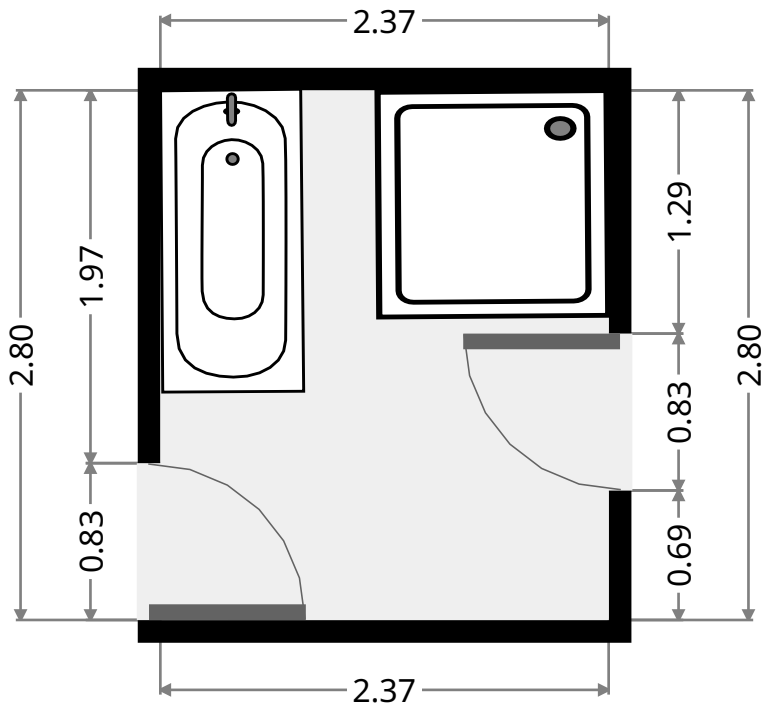
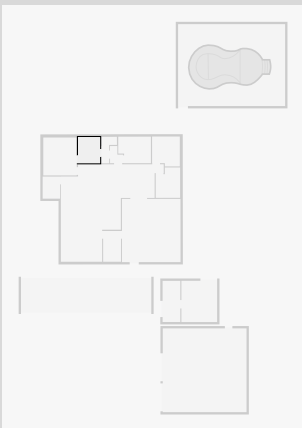

THIS FLOORPLAN IS PROVIDED WITHOUT WARRANTY OF ANY KIND. SENSOPIA DISCLAIMS ANY WARRANTY INCLUDING, WITHOUT LIMITATION, SATISFACTORY QUALITY OR ACCURACY OF DIMENSIONS.

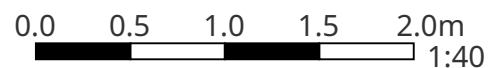

45 Fons Drive

Toilet

Width: 0.87 m
 Length: 1.65 m
 Area: 1.44 m²
 Perimeter: 5.05 m

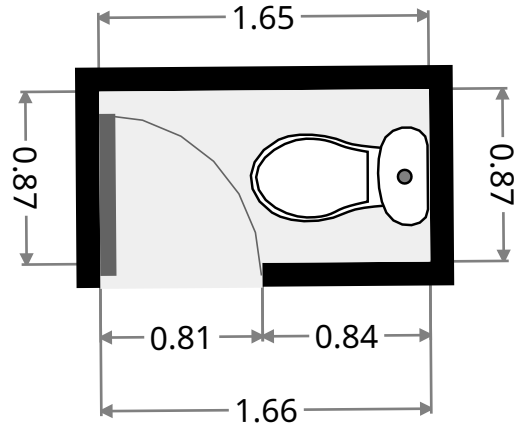
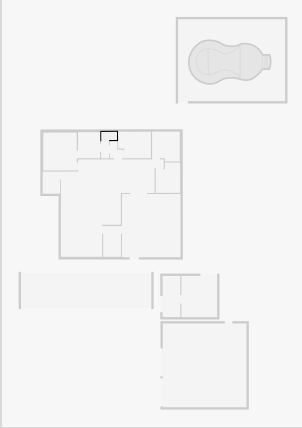

Hall

Width: 0.88 m
 Length: 1.86 m
 Area: 1.62 m²
 Perimeter: 5.45 m

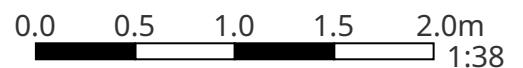
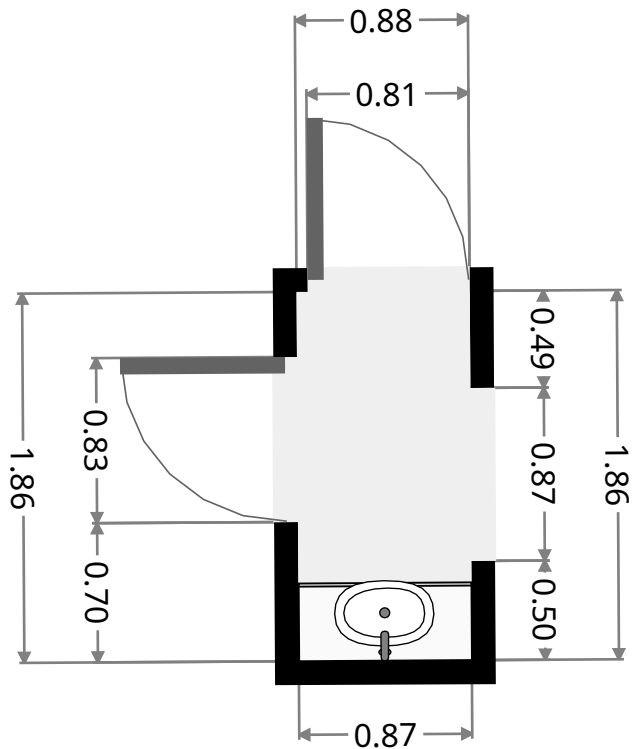
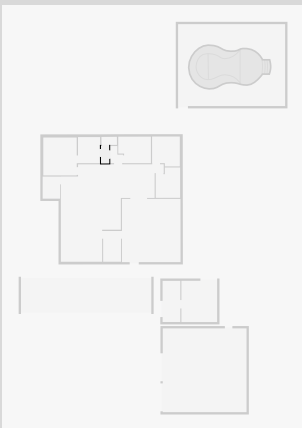

THIS FLOORPLAN IS PROVIDED WITHOUT WARRANTY OF ANY KIND. SENSOPIA DISCLAIMS ANY WARRANTY INCLUDING, WITHOUT LIMITATION, SATISFACTORY QUALITY OR ACCURACY OF DIMENSIONS.

45 Fons Drive

Hall

Width: 1.39 m
 Length: 1.84 m
 Area: 2.00 m²
 Perimeter: 6.46 m

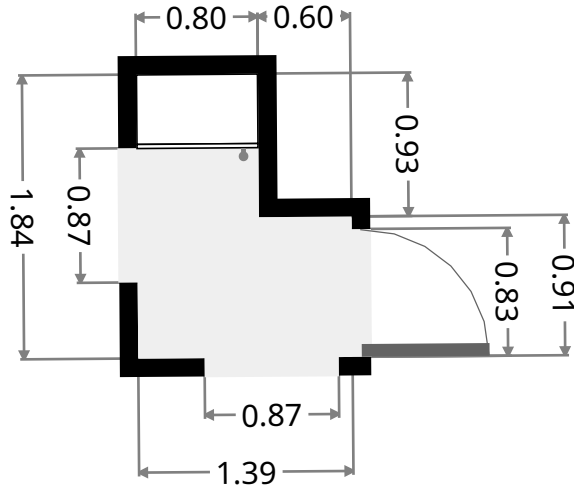
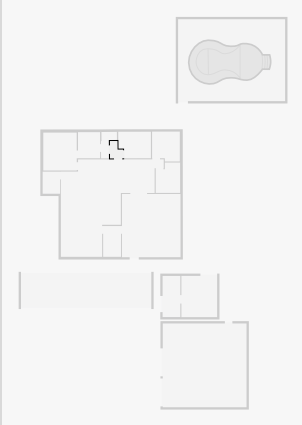

Master Bedroom

Width: 3.58 m
 Length: 4.07 m
 Area: 14.62 m²
 Perimeter: 15.32 m

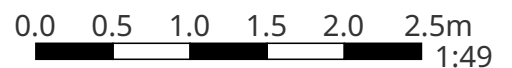
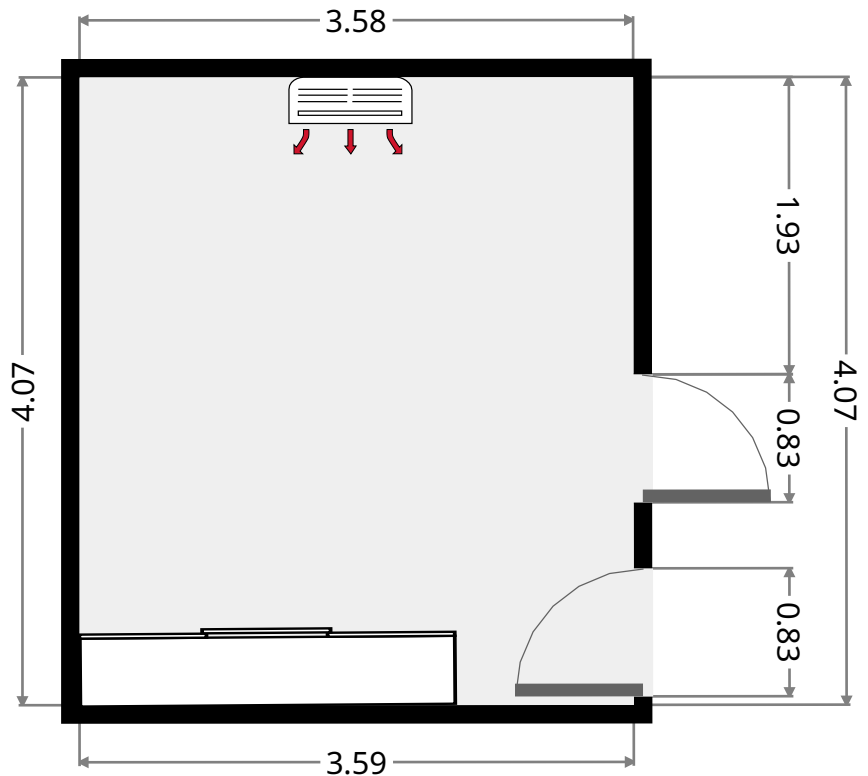
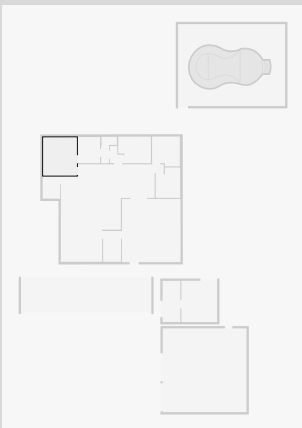

THIS FLOORPLAN IS PROVIDED WITHOUT WARRANTY OF ANY KIND. SENSOPIA DISCLAIMS ANY WARRANTY INCLUDING, WITHOUT LIMITATION, SATISFACTORY QUALITY OR ACCURACY OF DIMENSIONS.

45 Fons Drive

Laundry Room

Width: 1.92 m
Length: 3.31 m
Area: 6.33 m²
Perimeter: 10.44 m

