

44 Stringybark Avenue

Ground Floor

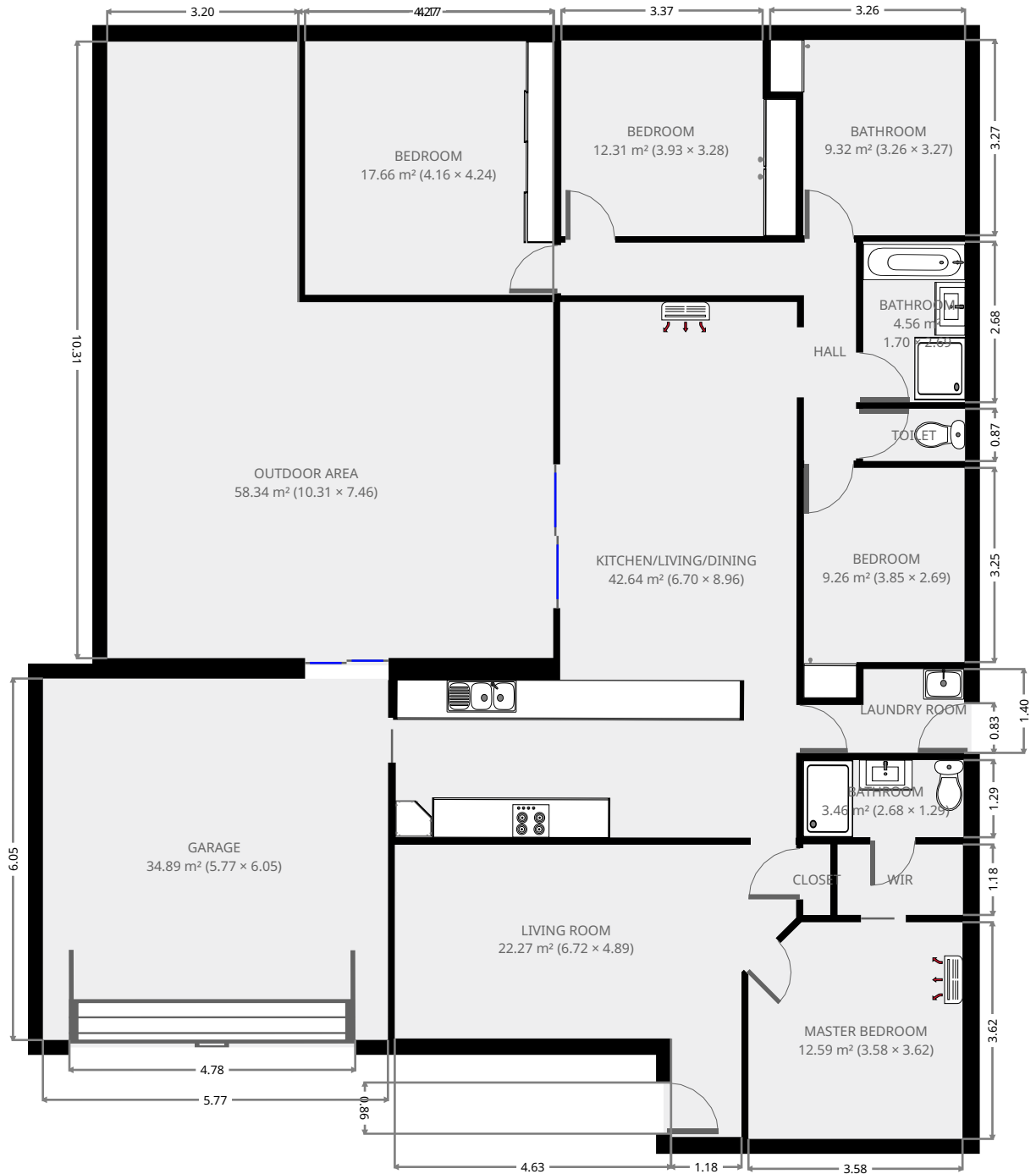

THIS FLOORPLAN IS PROVIDED WITHOUT WARRANTY OF ANY KIND. SENSOPIA DISCLAIMS ANY WARRANTY INCLUDING, WITHOUT LIMITATION, SATISFACTORY QUALITY OR ACCURACY OF DIMENSIONS.



44 Stringybark Avenue

WIR

Width: 1.18 m
Length: 2.10 m
Area: 2.47 m²
Perimeter: 6.55 m

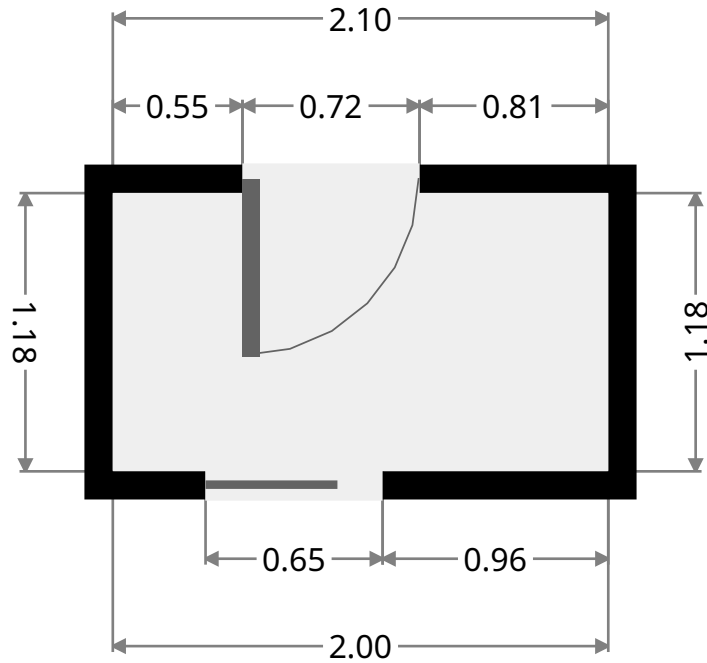
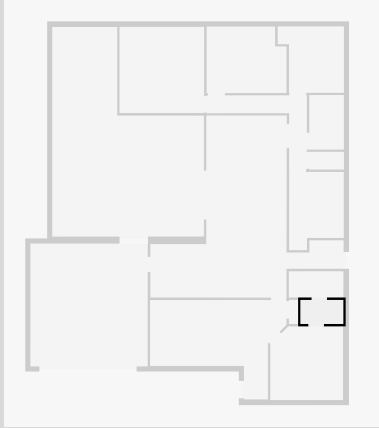

Bathroom

Width: 1.29 m
Length: 2.68 m
Area: 3.46 m²
Perimeter: 7.95 m

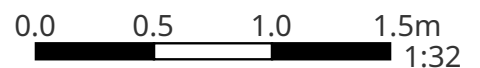
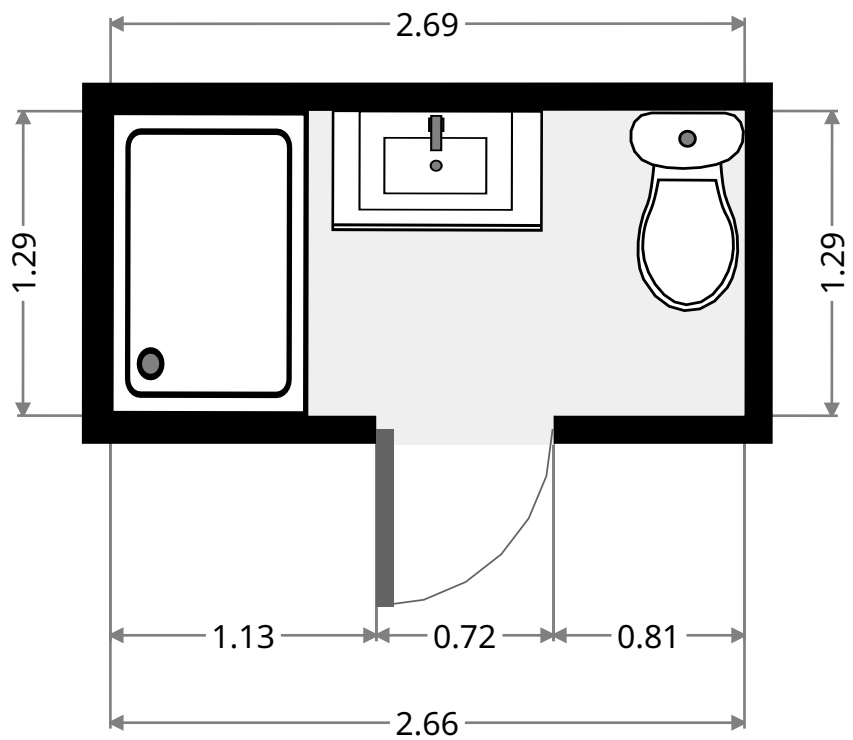
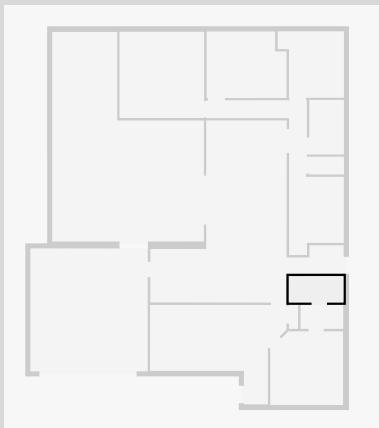

THIS FLOORPLAN IS PROVIDED WITHOUT WARRANTY OF ANY KIND. SENSOPIA DISCLAIMS ANY WARRANTY INCLUDING, WITHOUT LIMITATION, SATISFACTORY QUALITY OR ACCURACY OF DIMENSIONS.

44 Stringybark Avenue

Closet

Width: 0.45 m
Length: 1.18 m
Area: 0.53 m²
Perimeter: 3.27 m

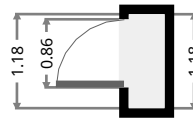
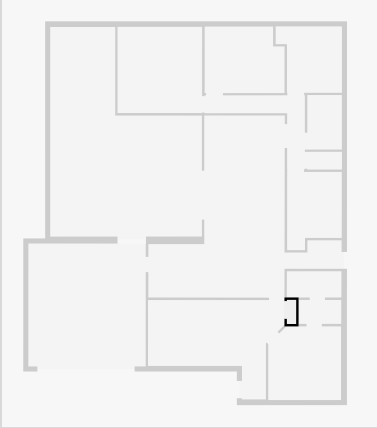

Kitchen/Living/Dining

Width: 6.70 m
Length: 8.96 m
Area: 42.64 m²
Perimeter: 31.32 m

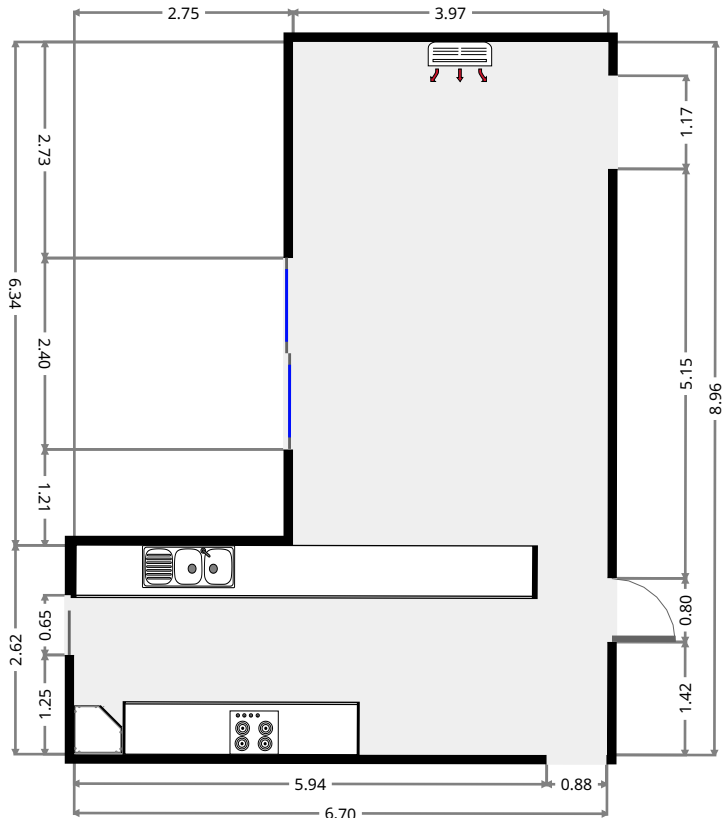
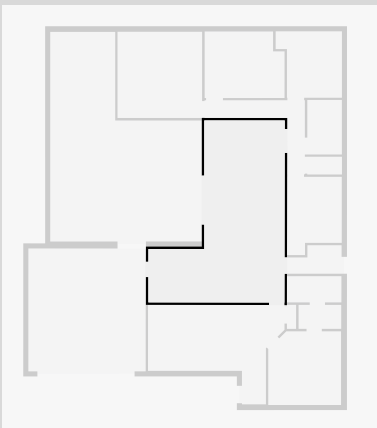

THIS FLOORPLAN IS PROVIDED WITHOUT WARRANTY OF ANY KIND. SENSOPIA DISCLAIMS ANY WARRANTY INCLUDING, WITHOUT LIMITATION, SATISFACTORY QUALITY OR ACCURACY OF DIMENSIONS.

44 Stringybark Avenue

Hall

Width: 3.64 m
Length: 4.93 m
Area: 6.75 m²
Perimeter: 17.16 m

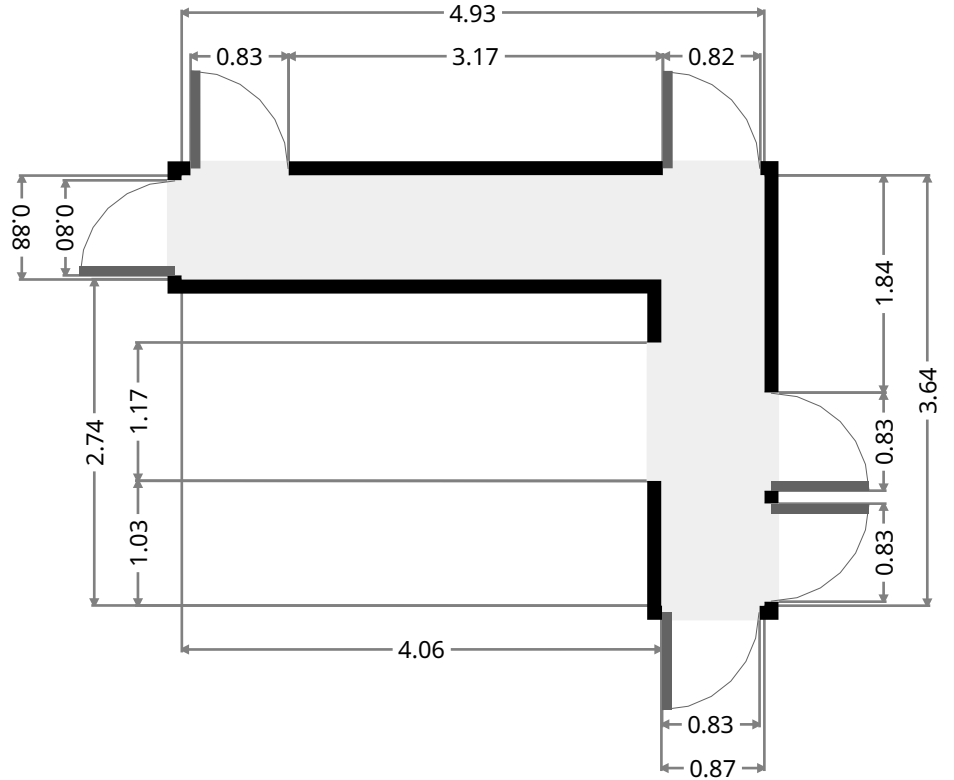

Bedroom

Width: 2.69 m
Length: 3.85 m
Area: 9.26 m²
Perimeter: 13.07 m

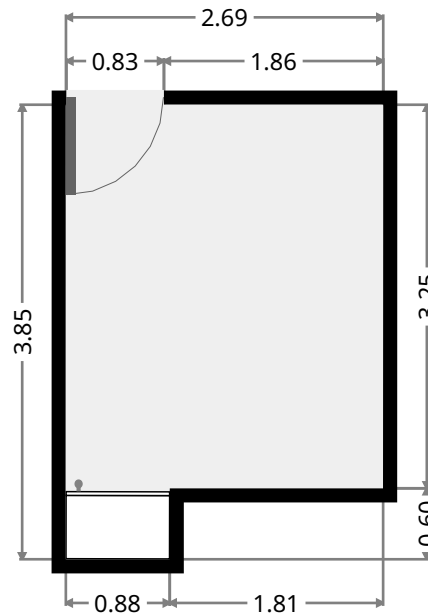
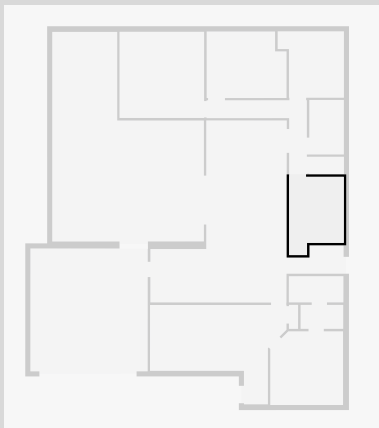

44 Stringybark Avenue

Laundry Room

Width: 1.40 m
 Length: 2.69 m
 Area: 3.16 m²
 Perimeter: 8.17 m

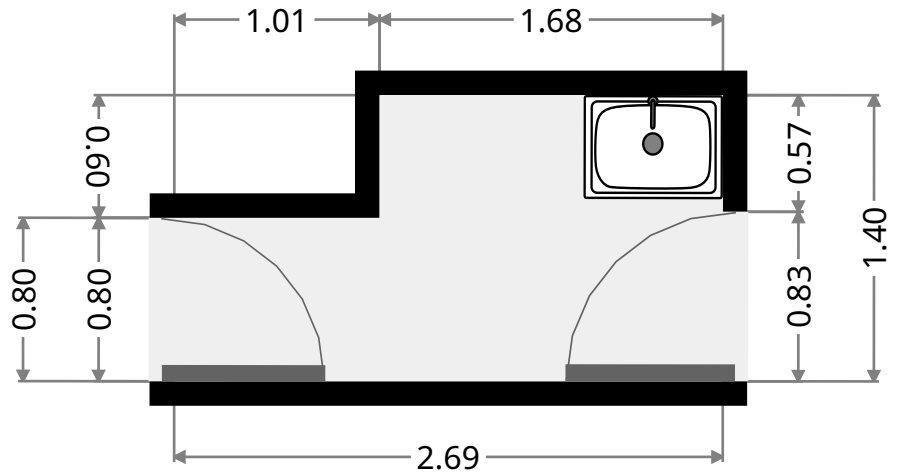
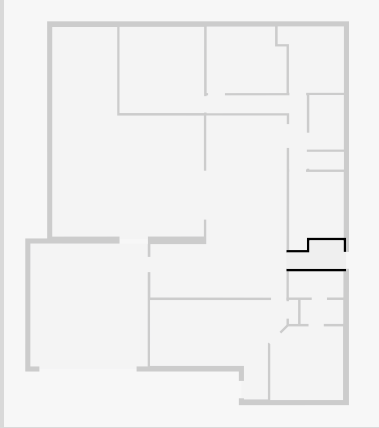

Toilet

Width: 0.88 m
 Length: 1.71 m
 Area: 1.49 m²
 Perimeter: 5.16 m

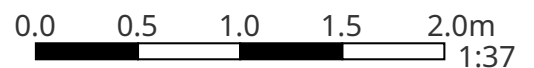
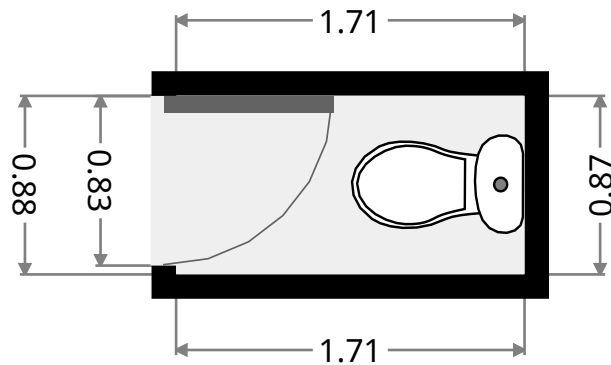

44 Stringybark Avenue

Bathroom

Width: 1.70 m
 Length: 2.69 m
 Area: 4.56 m²
 Perimeter: 8.77 m

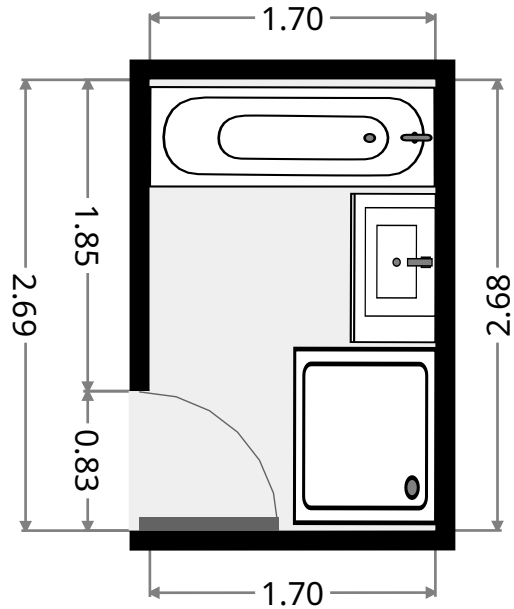
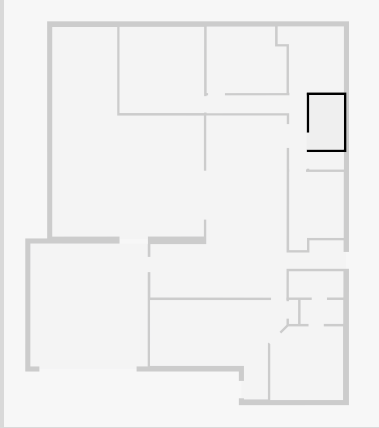

Bathroom

Width: 3.26 m
 Length: 3.27 m
 Area: 9.32 m²
 Perimeter: 13.05 m

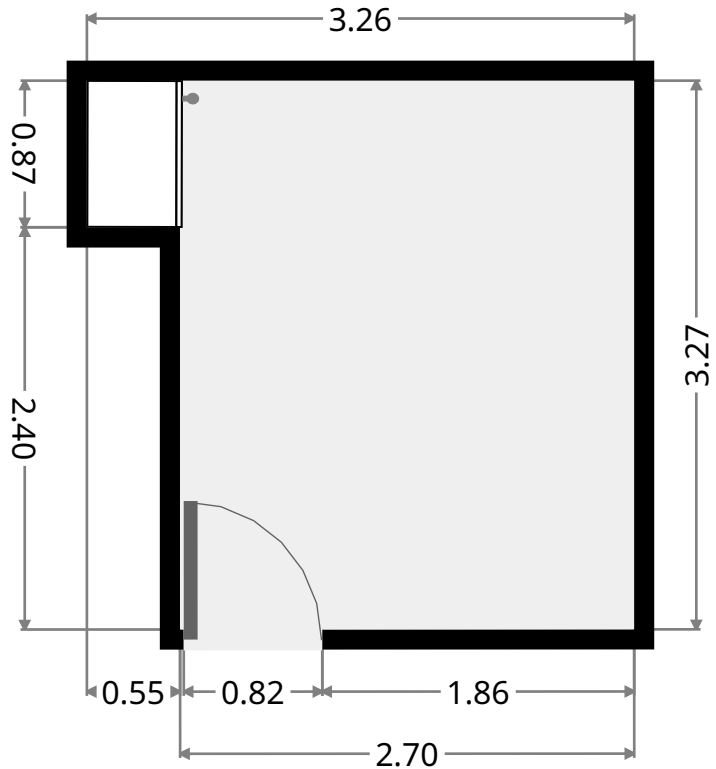
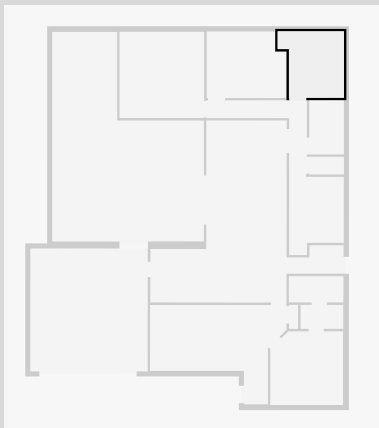

44 Stringybark Avenue

Bedroom

Width: 3.28 m
 Length: 3.93 m
 Area: 12.31 m²
 Perimeter: 14.41 m

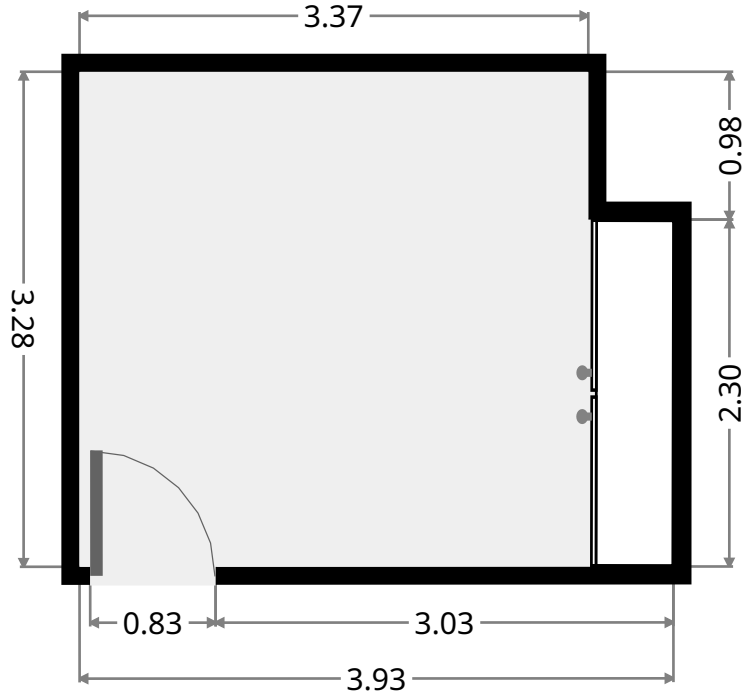
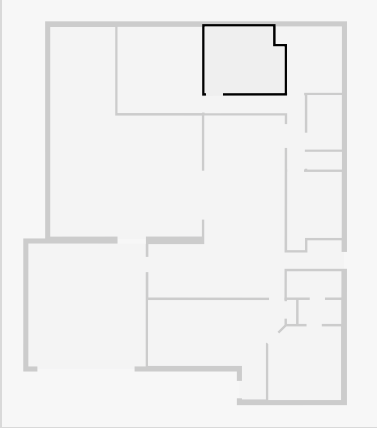

Bedroom

Width: 4.16 m
 Length: 4.24 m
 Area: 17.66 m²
 Perimeter: 16.81 m

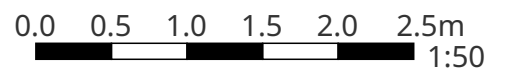
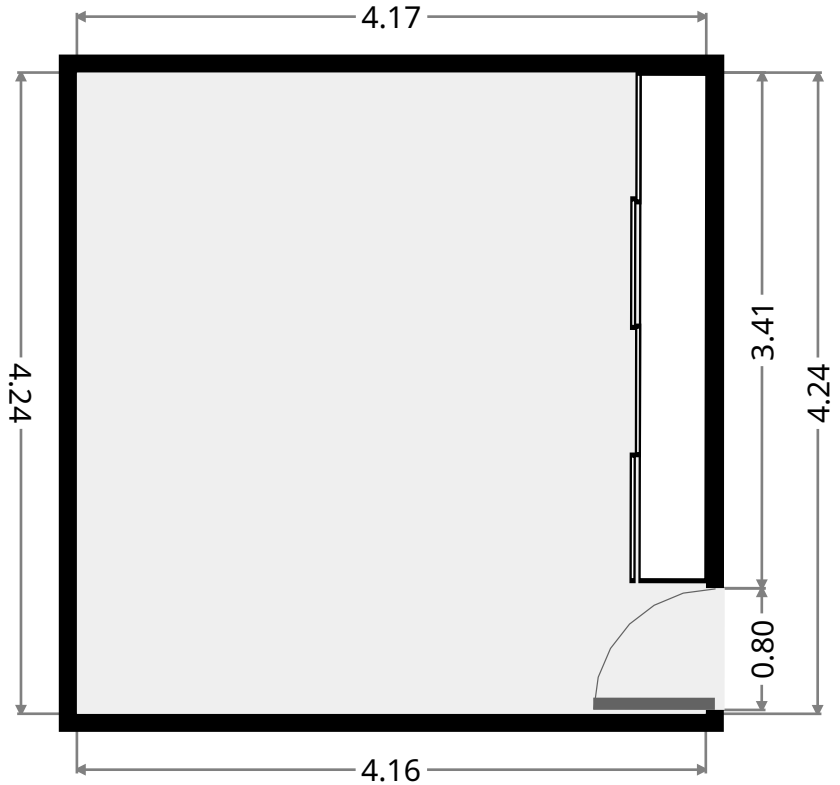
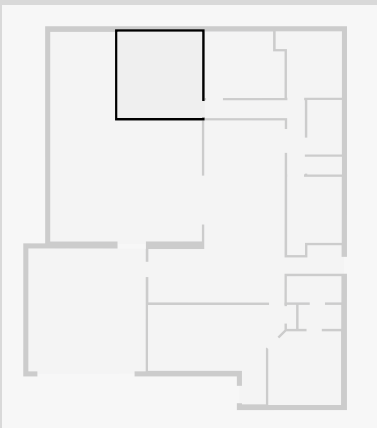

THIS FLOORPLAN IS PROVIDED WITHOUT WARRANTY OF ANY KIND. SENSOPIA DISCLAIMS ANY WARRANTY INCLUDING, WITHOUT LIMITATION, SATISFACTORY QUALITY OR ACCURACY OF DIMENSIONS.

44 Stringybark Avenue

Outdoor Area

Width: 7.46 m
Length: 10.31 m
Area: 58.34 m²
Perimeter: 35.54 m

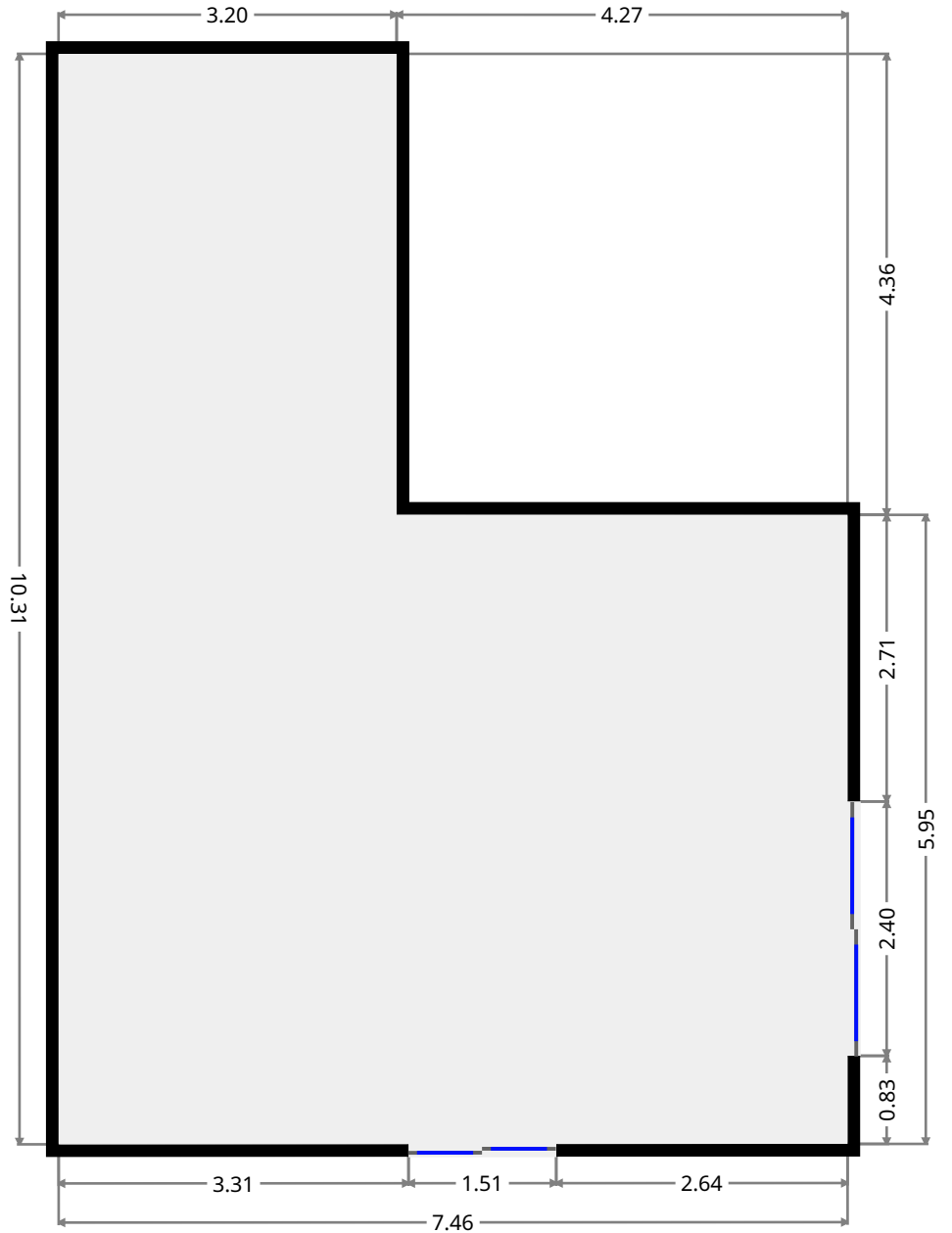
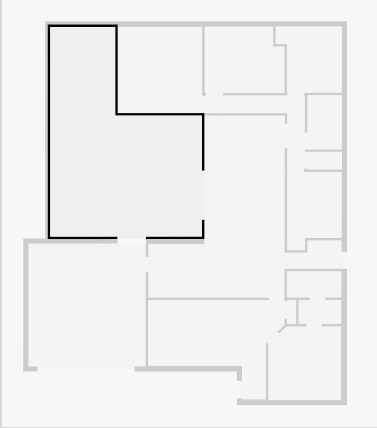

THIS FLOORPLAN IS PROVIDED WITHOUT WARRANTY OF ANY KIND. SENSOPIA DISCLAIMS ANY WARRANTY INCLUDING, WITHOUT LIMITATION, SATISFACTORY QUALITY OR ACCURACY OF DIMENSIONS.



44 Stringybark Avenue

Garage

Width: 5.77 m
Length: 6.05 m
Area: 34.89 m²
Perimeter: 23.63 m

