

42 Thozet Road

Ground Floor

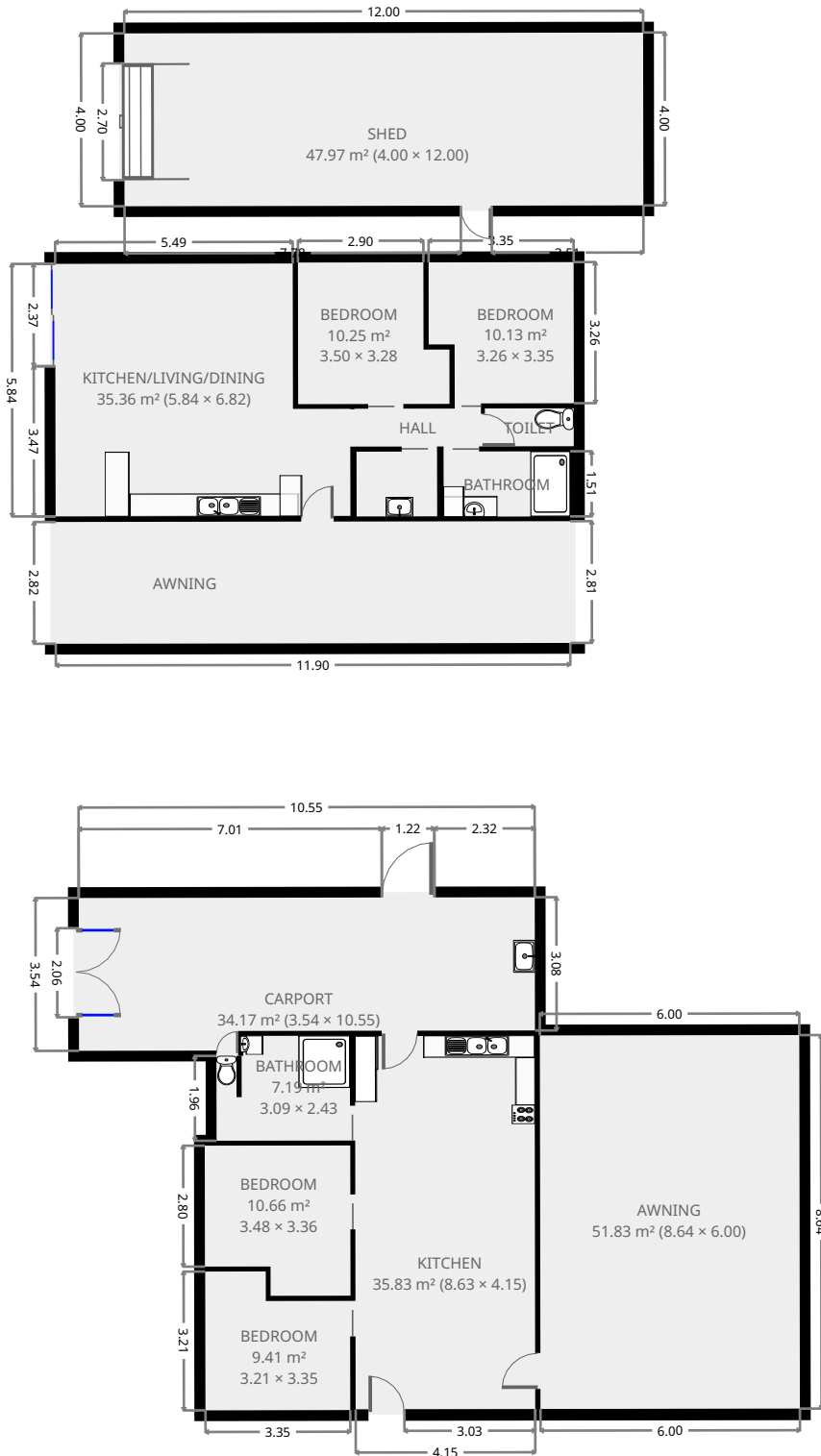

THIS FLOORPLAN IS PROVIDED WITHOUT WARRANTY OF ANY KIND. SENSOPIA DISCLAIMS ANY WARRANTY INCLUDING, WITHOUT LIMITATION, SATISFACTORY QUALITY OR ACCURACY OF DIMENSIONS.



42 Thozet Road

Kitchen/Living/Dining

Width: 5.84 m
 Length: 6.82 m
 Area: 35.36 m²
 Perimeter: 25.32 m

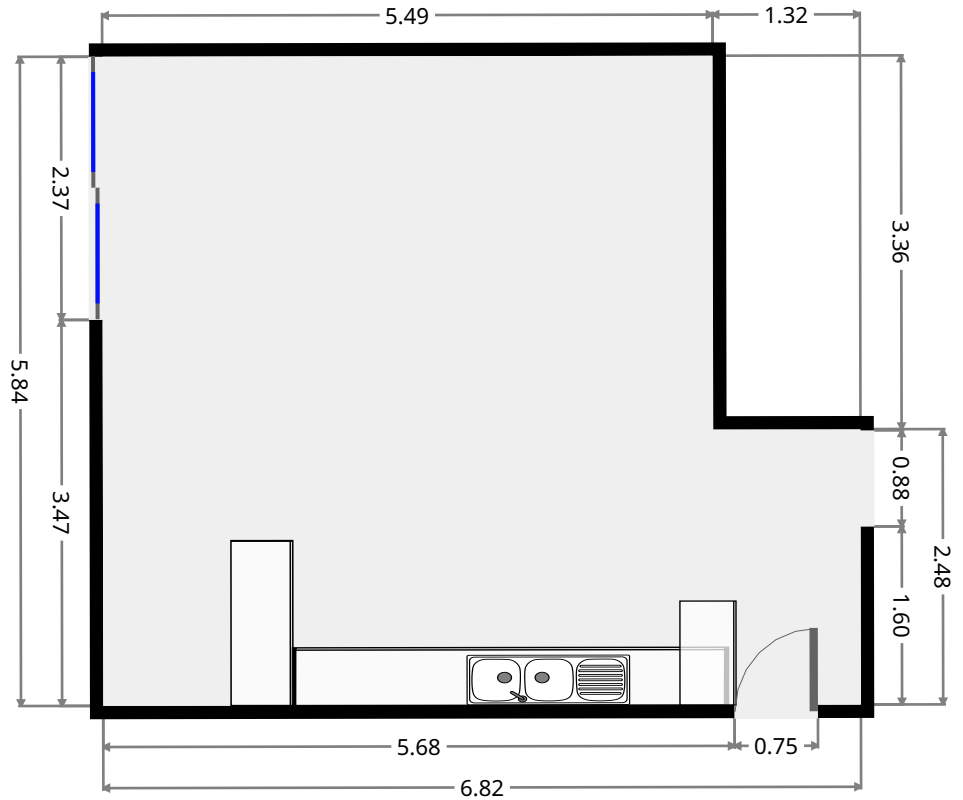
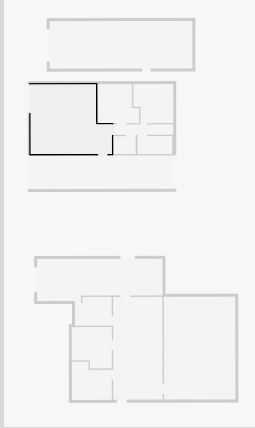

Hall

Width: 0.88 m
 Length: 2.94 m
 Area: 2.56 m²
 Perimeter: 7.60 m

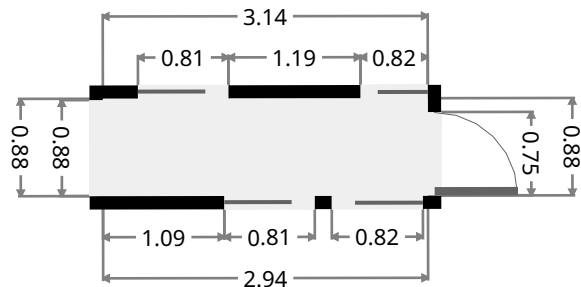
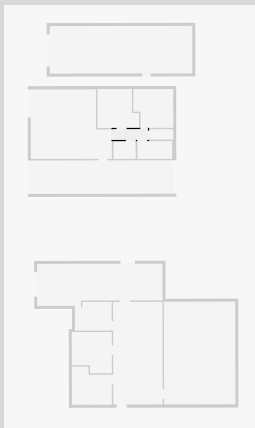

42 Thozet Road

Bedroom

Width: 3.28 m
Length: 3.50 m
Area: 10.25 m²
Perimeter: 13.55 m

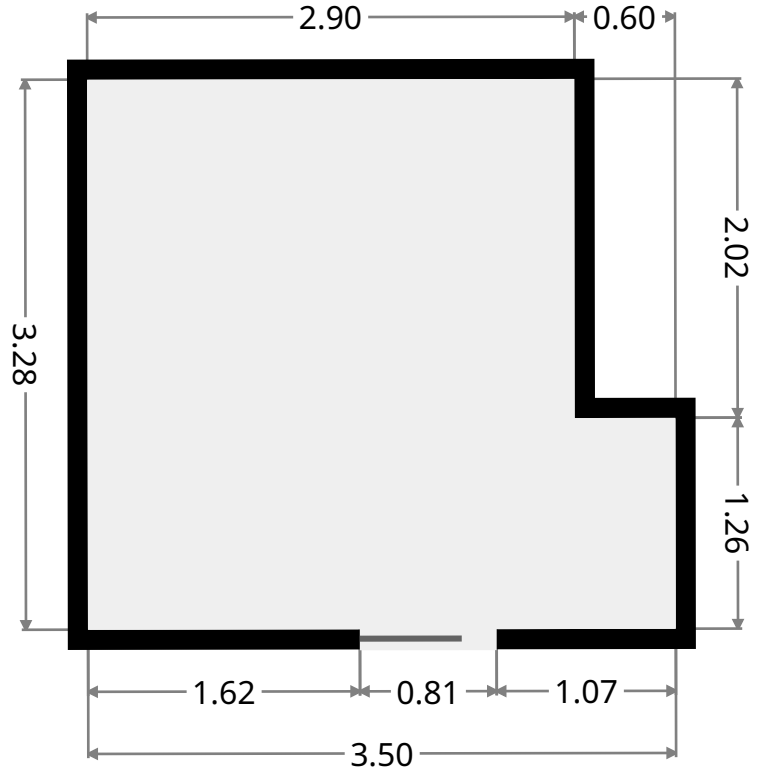
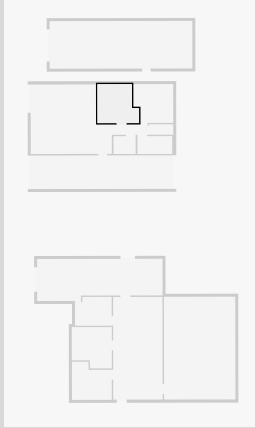

Laundry Room

Width: 1.50 m
Length: 1.85 m
Area: 2.79 m²
Perimeter: 6.72 m

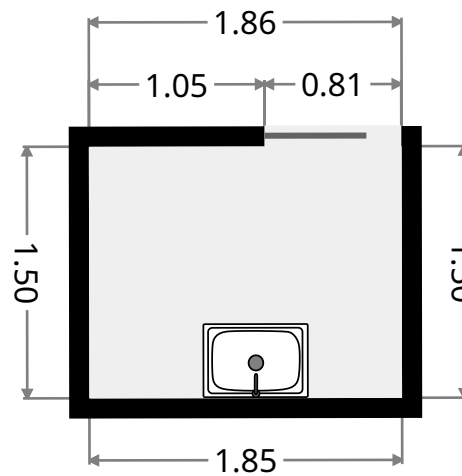
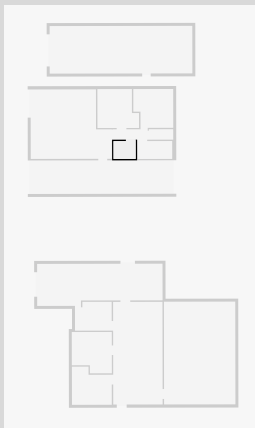

42 Thozet Road

Bathroom

Width: 1.51 m
Length: 2.92 m
Area: 4.40 m²
Perimeter: 8.86 m

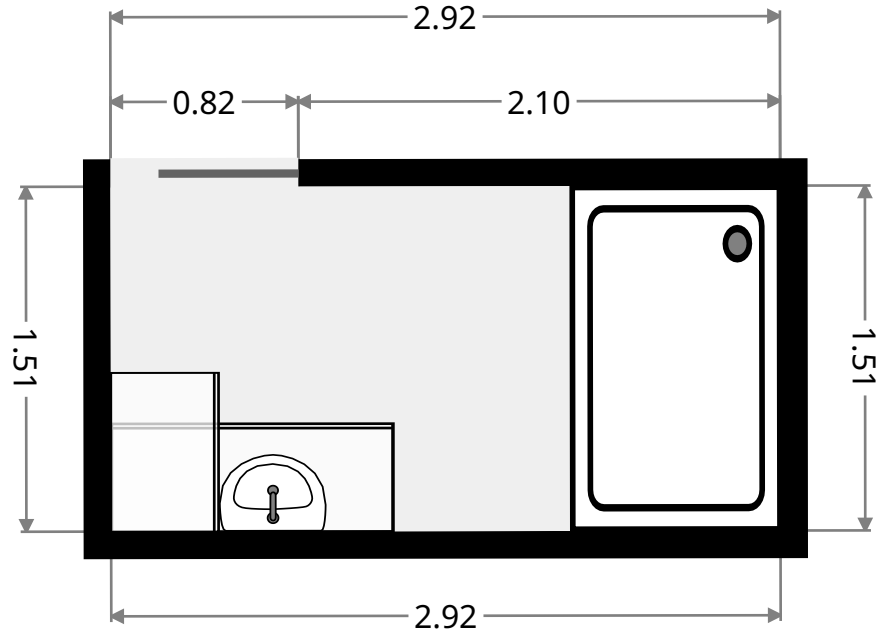
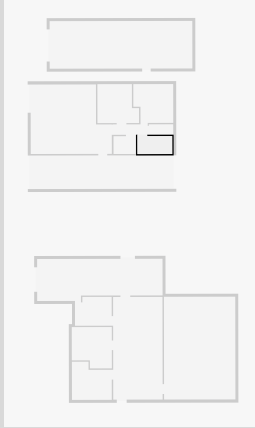

Toilet

Width: 0.88 m
Length: 2.06 m
Area: 1.80 m²
Perimeter: 5.86 m

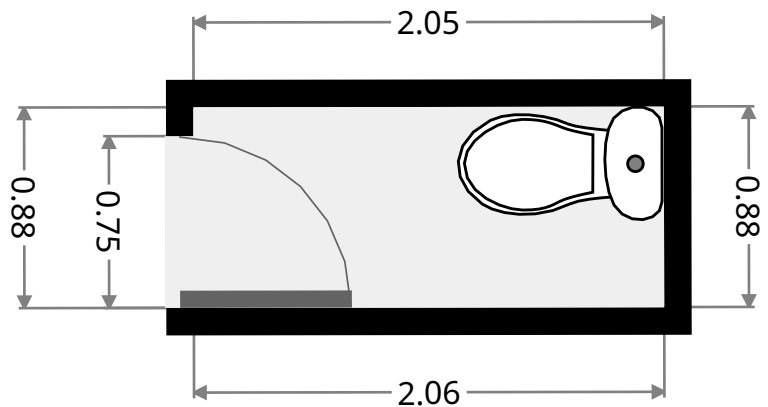
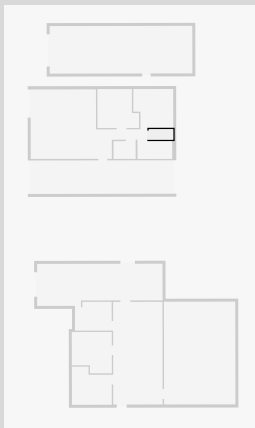

42 Thozet Road

Bedroom

Width: 3.26 m
Length: 3.35 m
Area: 10.13 m²
Perimeter: 13.23 m

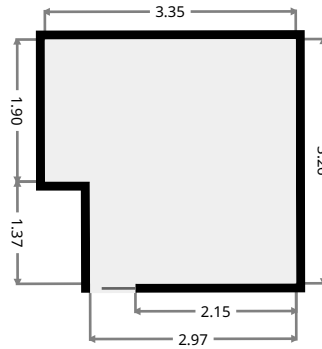
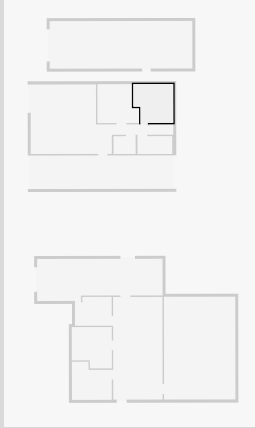

Awning

Width: 2.81 m
Length: 11.90 m
Area: 33.50 m²
Perimeter: 29.43 m

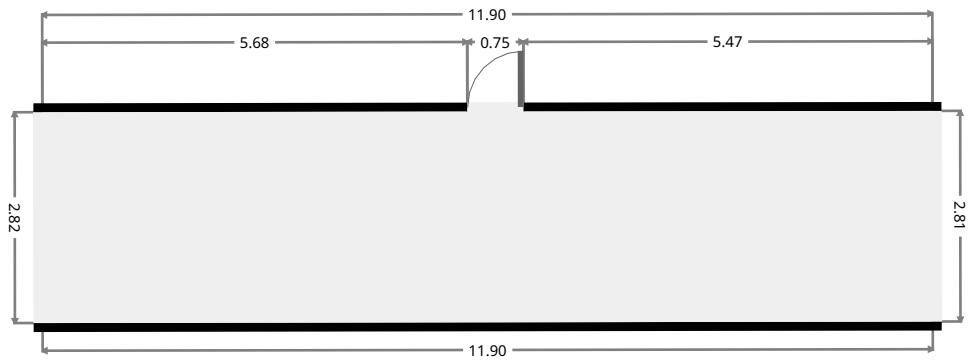
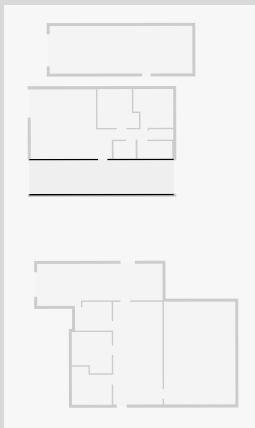

42 Thozet Road

Shed

Width: 4.00 m
Length: 12.00 m
Area: 47.97 m²
Perimeter: 31.99 m

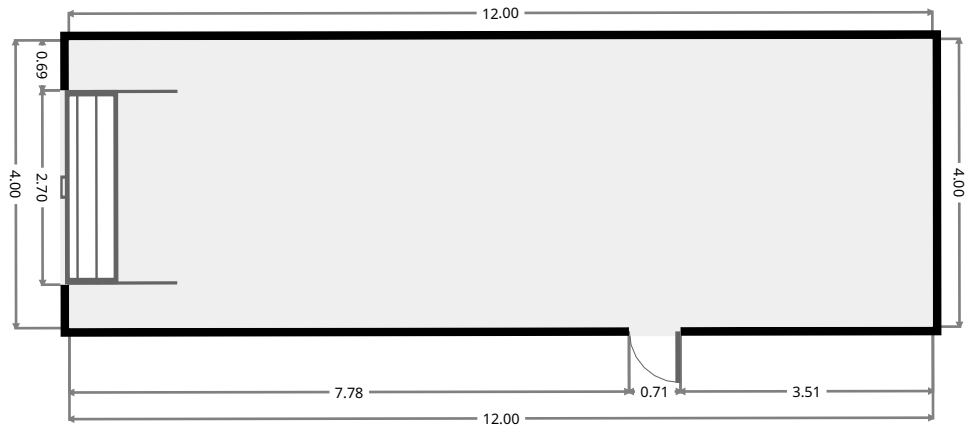
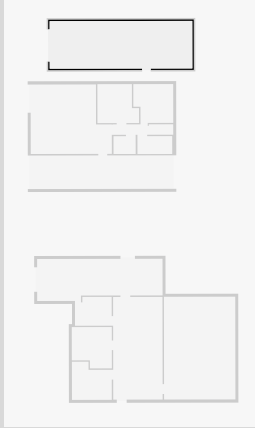

42 Thozet Road

Carport

Width: 3.54 m
Length: 10.55 m
Area: 34.17 m²
Perimeter: 28.16 m

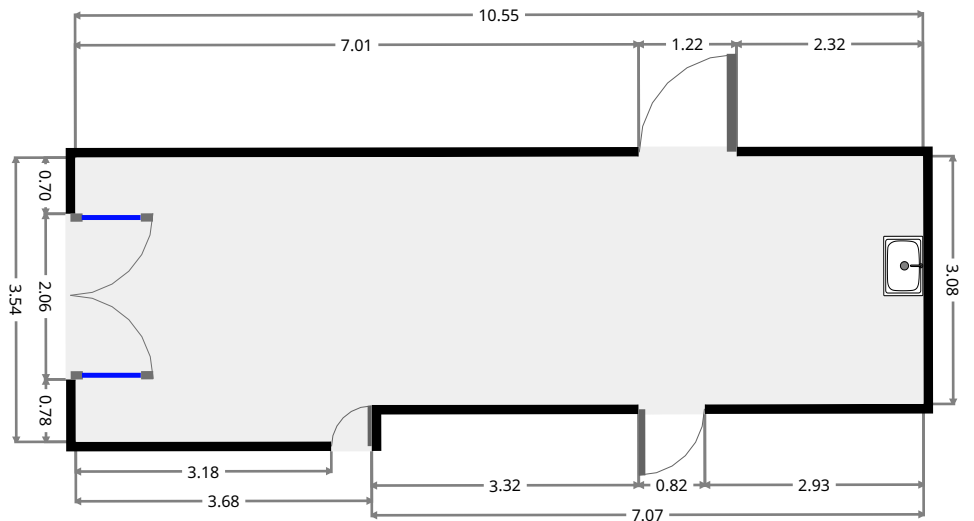
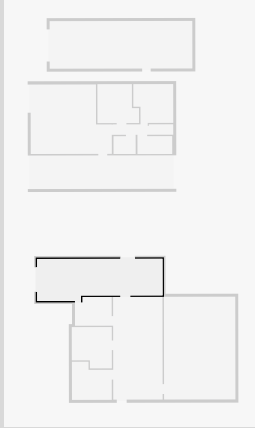

THIS FLOORPLAN IS PROVIDED WITHOUT WARRANTY OF ANY KIND. SENSOPIA DISCLAIMS ANY WARRANTY INCLUDING, WITHOUT LIMITATION, SATISFACTORY QUALITY OR ACCURACY OF DIMENSIONS.

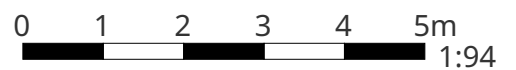

42 Thozet Road

Kitchen

Width: 4.15 m
 Length: 8.63 m
 Area: 35.83 m²
 Perimeter: 25.56 m

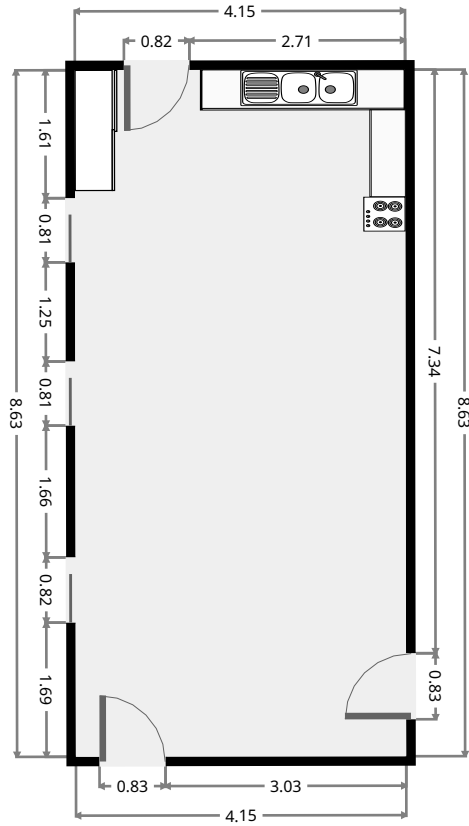
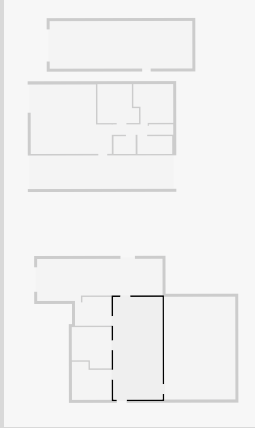

Bedroom

Width: 3.21 m
 Length: 3.35 m
 Area: 9.41 m²
 Perimeter: 13.12 m

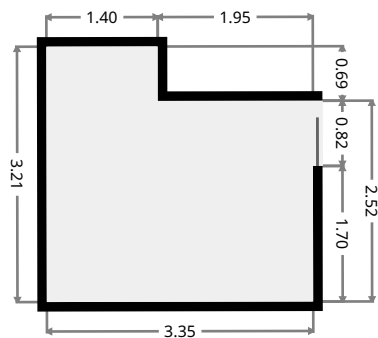

42 Thozet Road

Bedroom

Width: 3.36 m
Length: 3.48 m
Area: 10.66 m²
Perimeter: 13.68 m

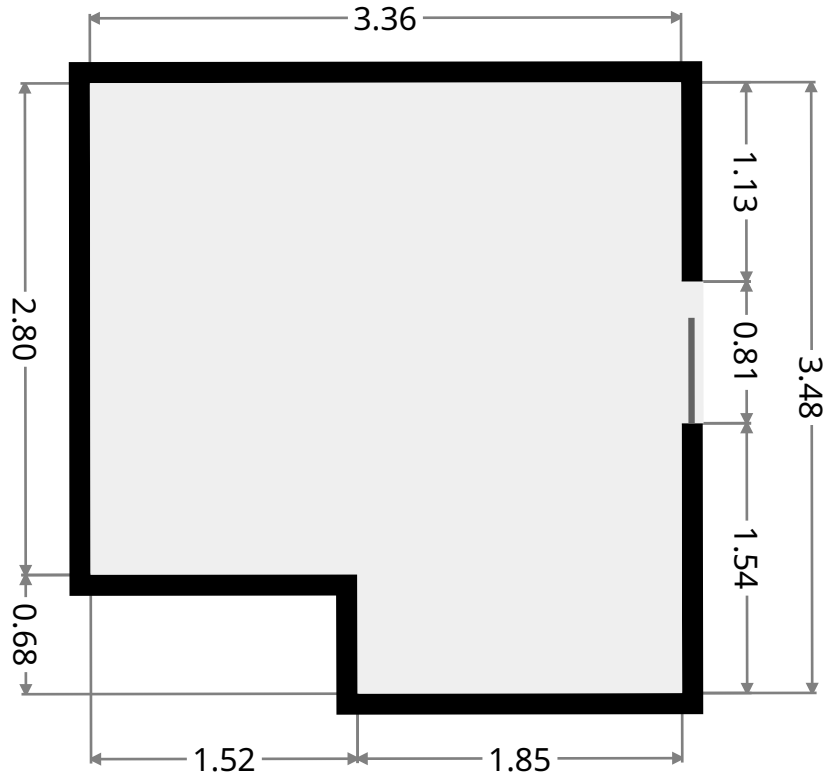
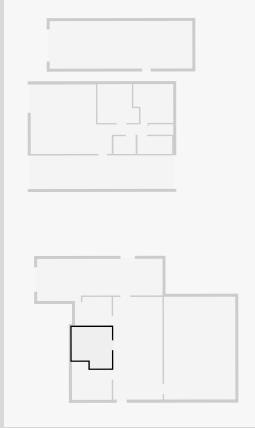

Bathroom

Width: 2.43 m
Length: 3.09 m
Area: 7.19 m²
Perimeter: 11.02 m

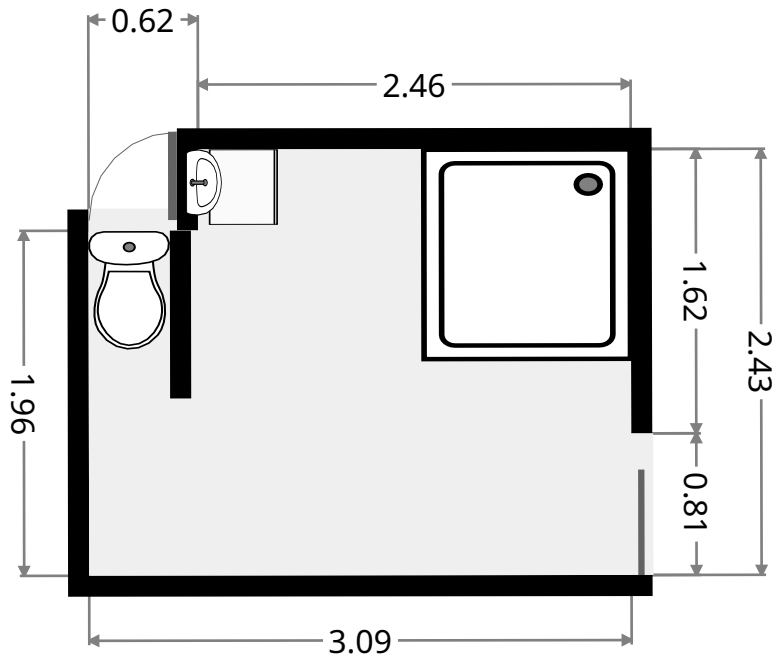
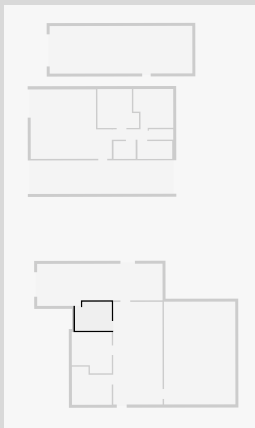

THIS FLOORPLAN IS PROVIDED WITHOUT WARRANTY OF ANY KIND. SENSOPIA DISCLAIMS ANY WARRANTY INCLUDING, WITHOUT LIMITATION, SATISFACTORY QUALITY OR ACCURACY OF DIMENSIONS.

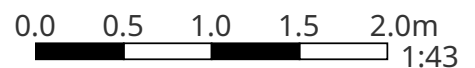

42 Thozet Road

Awning

Width: 6.00 m
Length: 8.64 m
Area: 51.83 m²
Perimeter: 29.28 m

