

363 Lawrence Avenue

Ground Floor

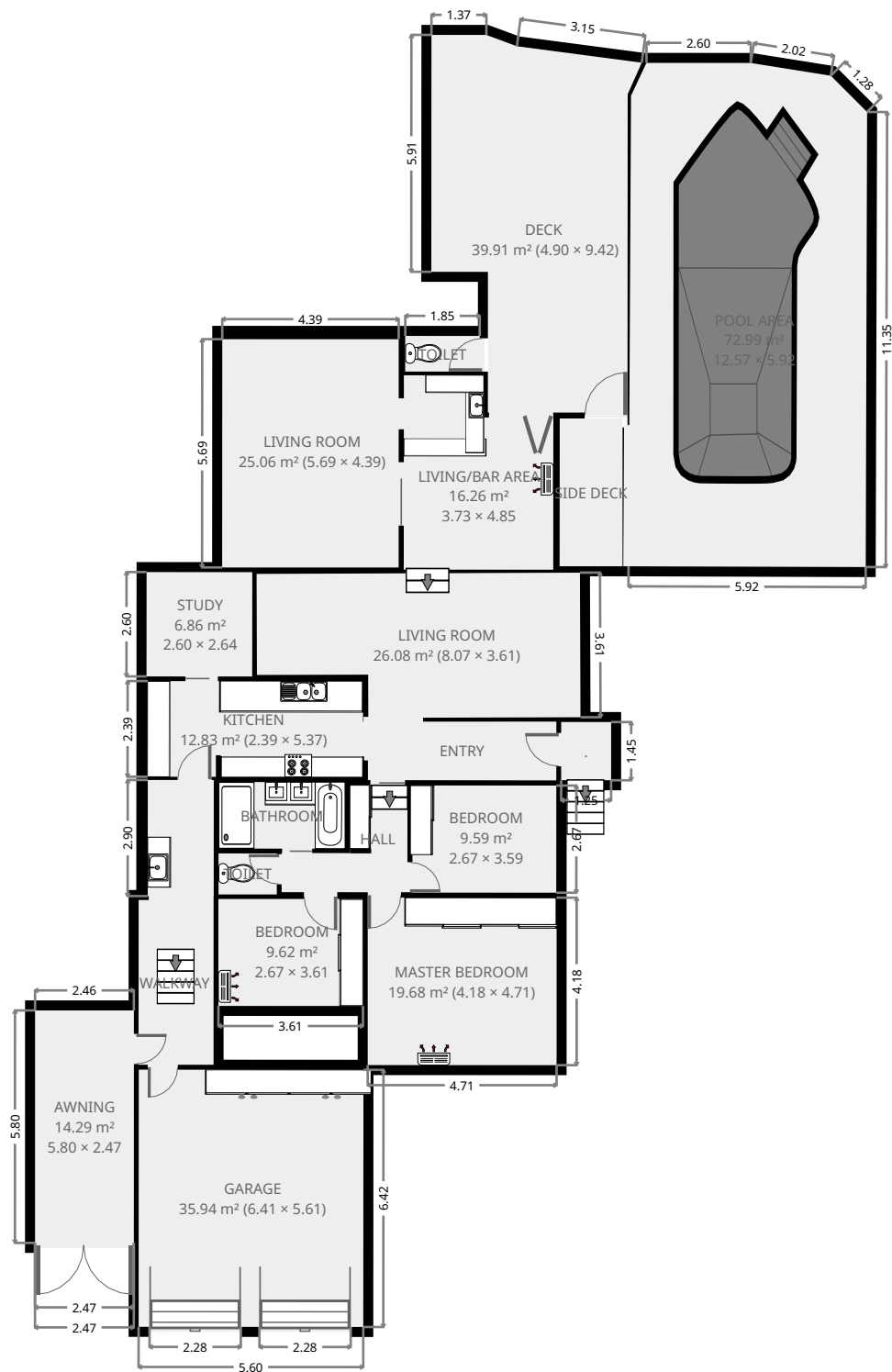

THIS FLOORPLAN IS PROVIDED WITHOUT WARRANTY OF ANY KIND. SENSOPIA DISCLAIMS ANY WARRANTY INCLUDING, WITHOUT LIMITATION, SATISFACTORY QUALITY OR ACCURACY OF DIMENSIONS.



363 Lawrence Avenue

Toilet

Width: 1.02 m
Length: 1.45 m
Area: 1.49 m²
Perimeter: 4.95 m

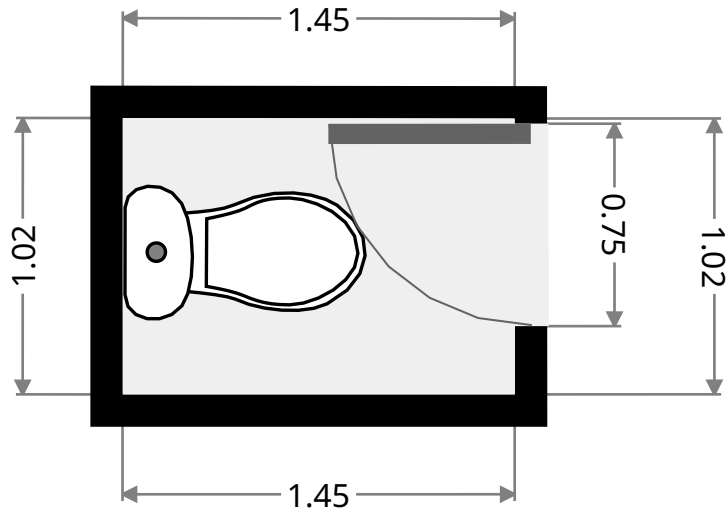
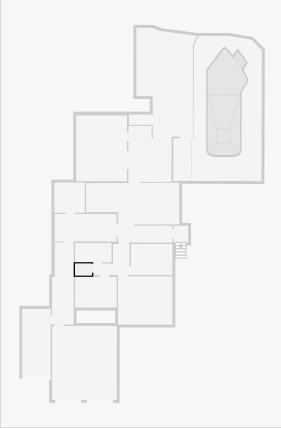

•
Width: 1.25 m
Length: 1.45 m
Area: 1.81 m²
Perimeter: 5.40 m

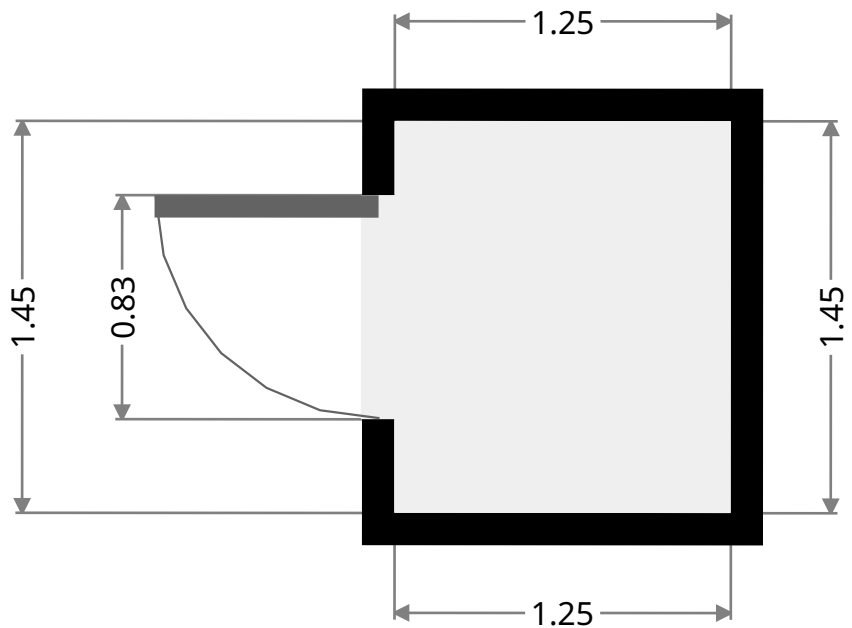
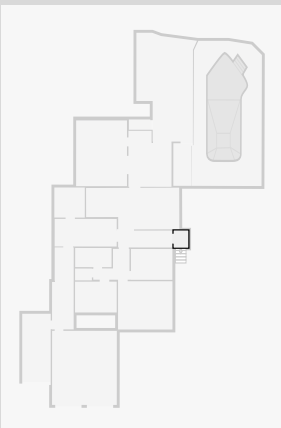

363 Lawrence Avenue

Walkway

Width: 1.87 m
 Length: 4.11 m
 Area: 7.68 m²
 Perimeter: 11.96 m

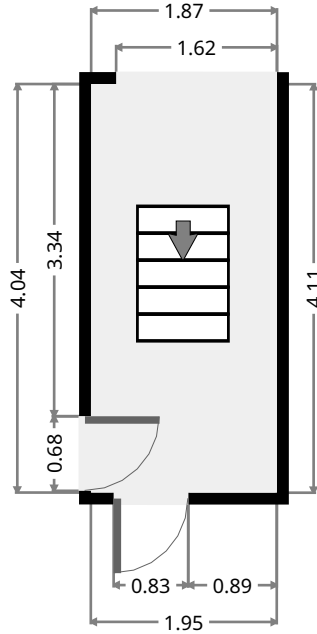
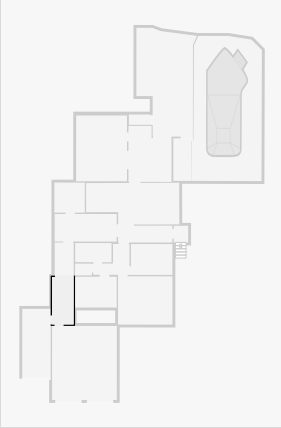

Awning

Width: 2.47 m
 Length: 5.80 m
 Area: 14.29 m²
 Perimeter: 16.53 m

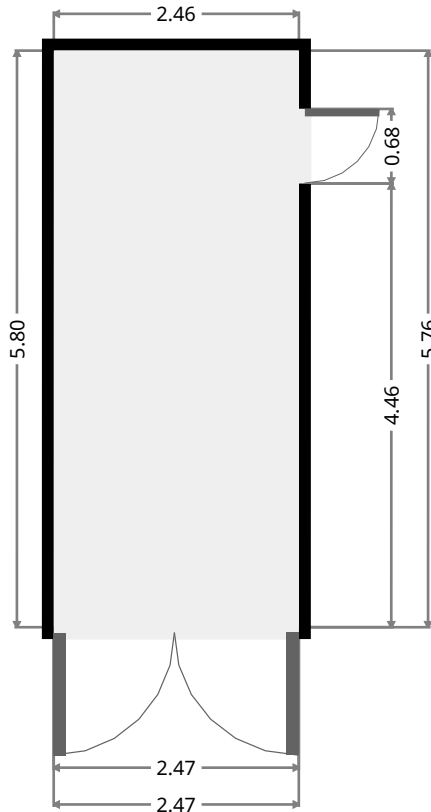
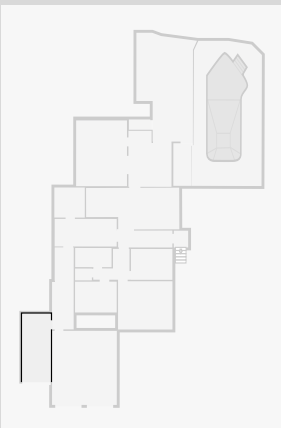

THIS FLOORPLAN IS PROVIDED WITHOUT WARRANTY OF ANY KIND. SENSOPIA DISCLAIMS ANY WARRANTY INCLUDING, WITHOUT LIMITATION, SATISFACTORY QUALITY OR ACCURACY OF DIMENSIONS.

363 Lawrence Avenue

Garage

Width: 5.61 m
Length: 6.41 m
Area: 35.94 m²
Perimeter: 24.04 m

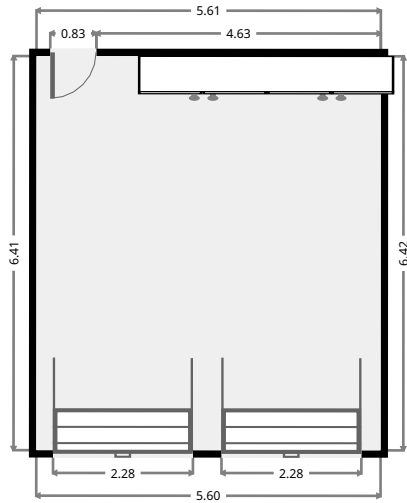
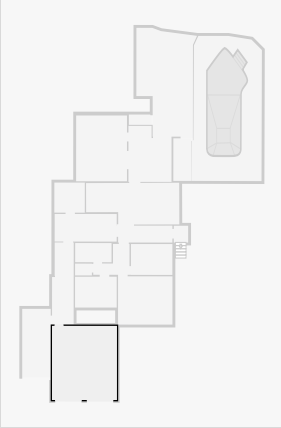

Pool Area

Width: 5.92 m
Length: 12.57 m
Area: 72.99 m²
Perimeter: 35.81 m

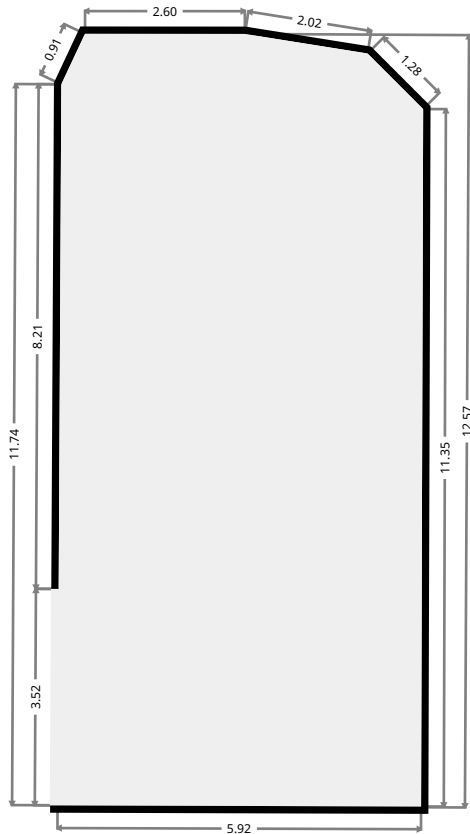
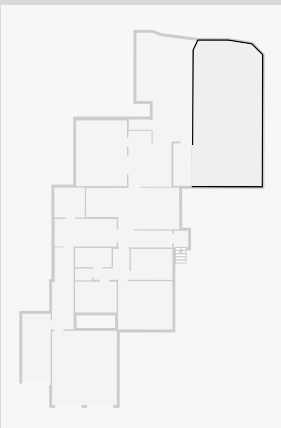

THIS FLOORPLAN IS PROVIDED WITHOUT WARRANTY OF ANY KIND. SENSOPIA DISCLAIMS ANY WARRANTY INCLUDING, WITHOUT LIMITATION, SATISFACTORY QUALITY OR ACCURACY OF DIMENSIONS.

363 Lawrence Avenue

Side Deck

Width: 1.56 m
Length: 3.69 m
Area: 5.78 m²
Perimeter: 10.51 m

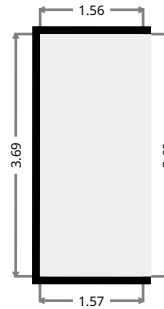
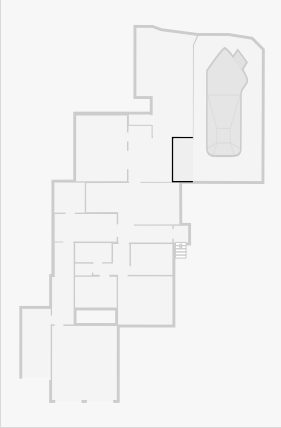

Deck

Width: 4.90 m
Length: 9.42 m
Area: 39.91 m²
Perimeter: 28.44 m

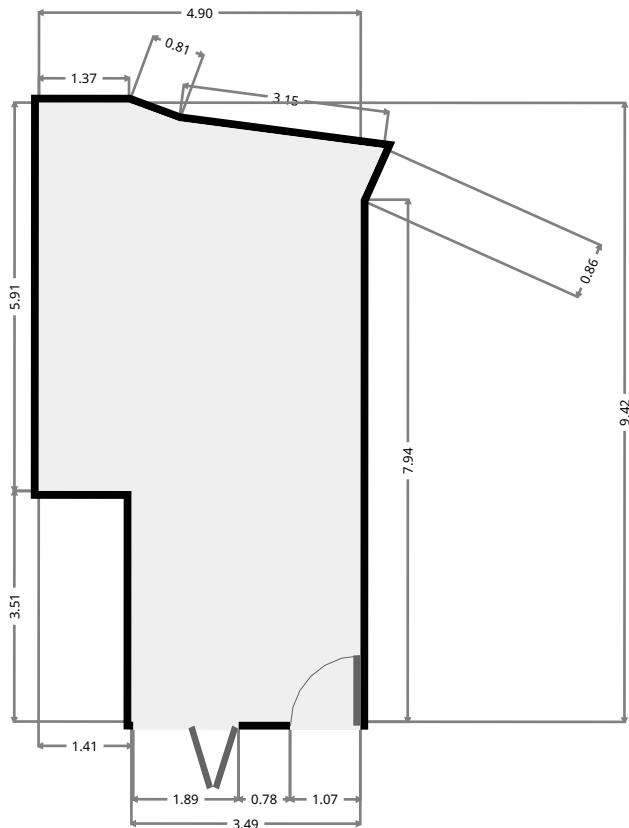
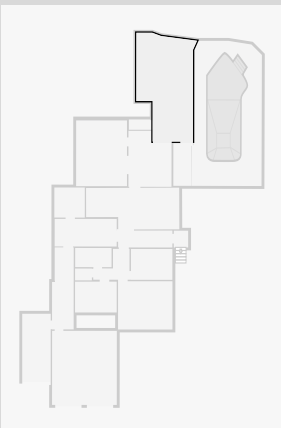

THIS FLOORPLAN IS PROVIDED WITHOUT WARRANTY OF ANY KIND. SENSOPIA DISCLAIMS ANY WARRANTY INCLUDING, WITHOUT LIMITATION, SATISFACTORY QUALITY OR ACCURACY OF DIMENSIONS.

363 Lawrence Avenue

Toilet

Width: 0.90 m
Length: 1.86 m
Area: 1.65 m²
Perimeter: 5.49 m

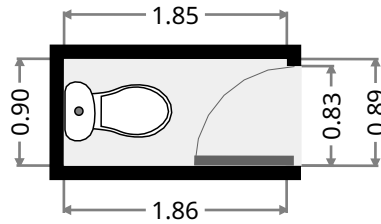
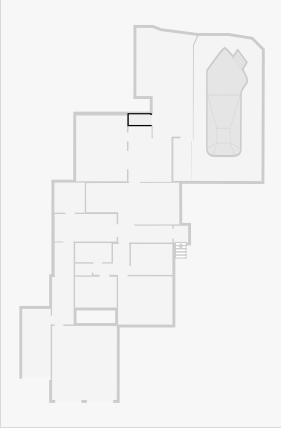

Living Room

Width: 4.39 m
Length: 5.69 m
Area: 25.06 m²
Perimeter: 20.19 m

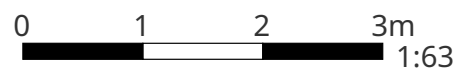
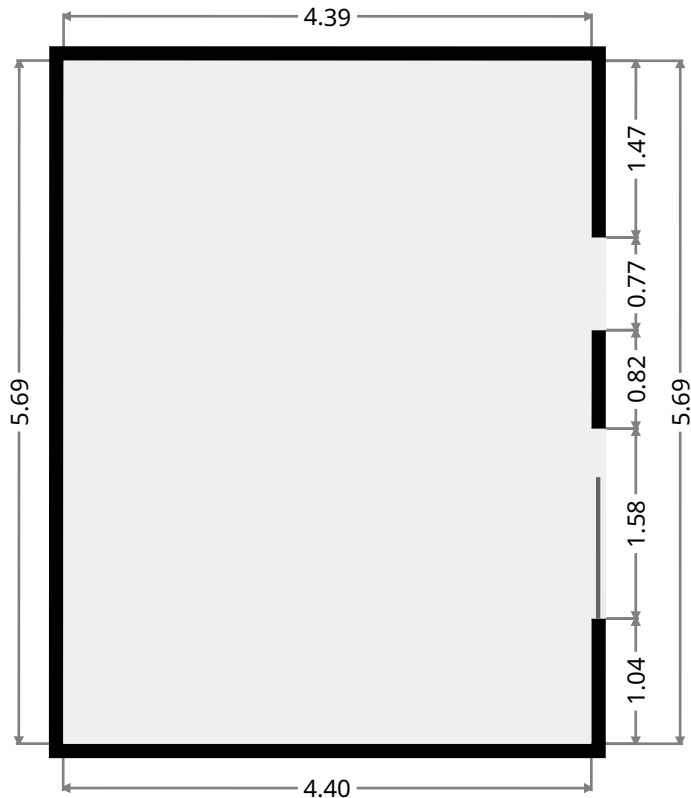
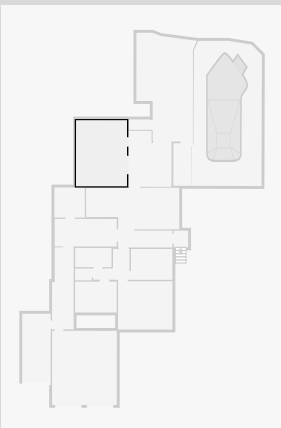

THIS FLOORPLAN IS PROVIDED WITHOUT WARRANTY OF ANY KIND. SENSOPIA DISCLAIMS ANY WARRANTY INCLUDING, WITHOUT LIMITATION, SATISFACTORY QUALITY OR ACCURACY OF DIMENSIONS.

363 Lawrence Avenue

Living/Bar Area

Width: 3.73 m
 Length: 4.85 m
 Area: 16.26 m²
 Perimeter: 17.15 m

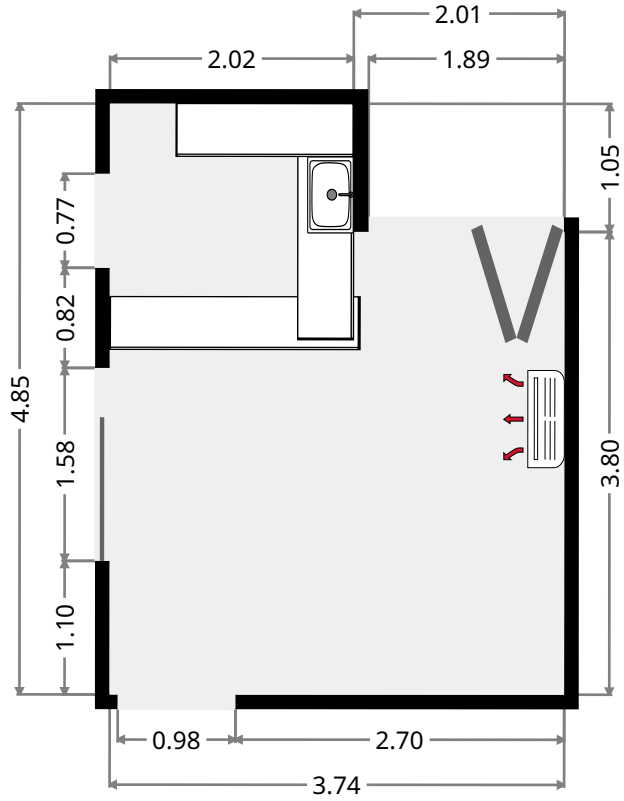
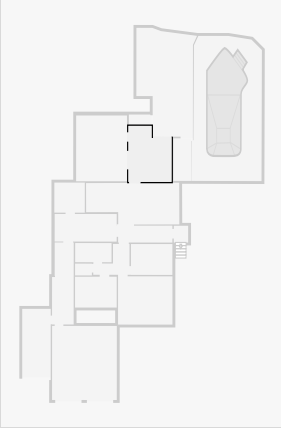

Entry

Width: 1.46 m
 Length: 4.70 m
 Area: 6.87 m²
 Perimeter: 12.32 m

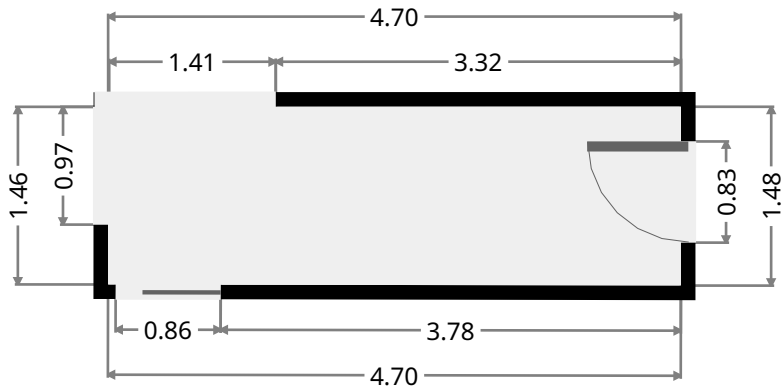
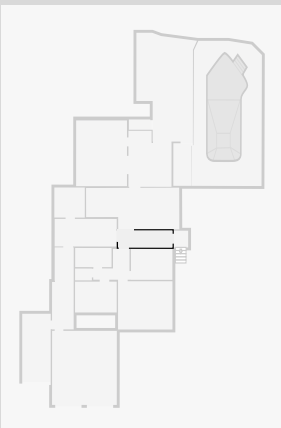

363 Lawrence Avenue

Bathroom

Width: 1.66 m
Length: 3.15 m
Area: 5.22 m²
Perimeter: 9.62 m

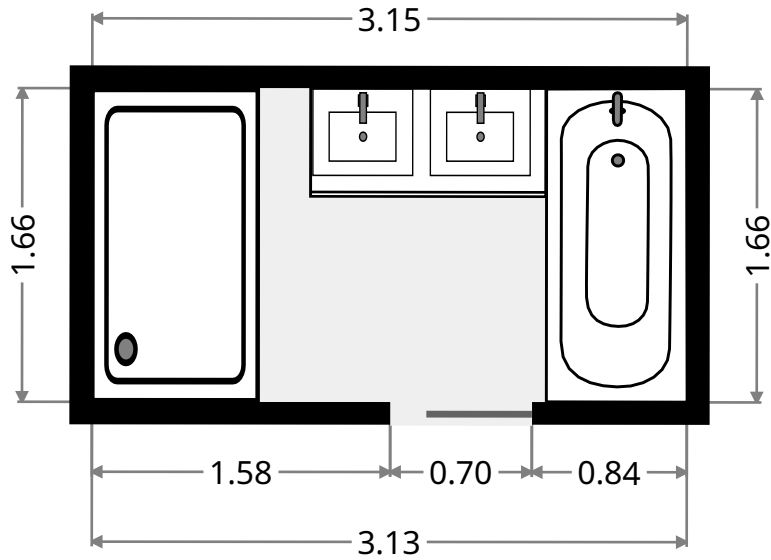
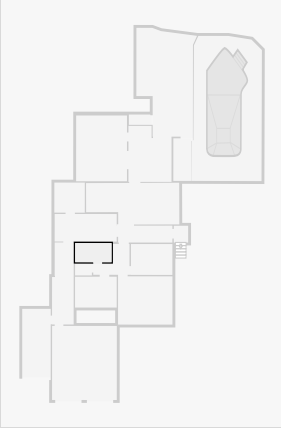

Bedroom

Width: 2.67 m
Length: 3.61 m
Area: 9.62 m²
Perimeter: 12.55 m

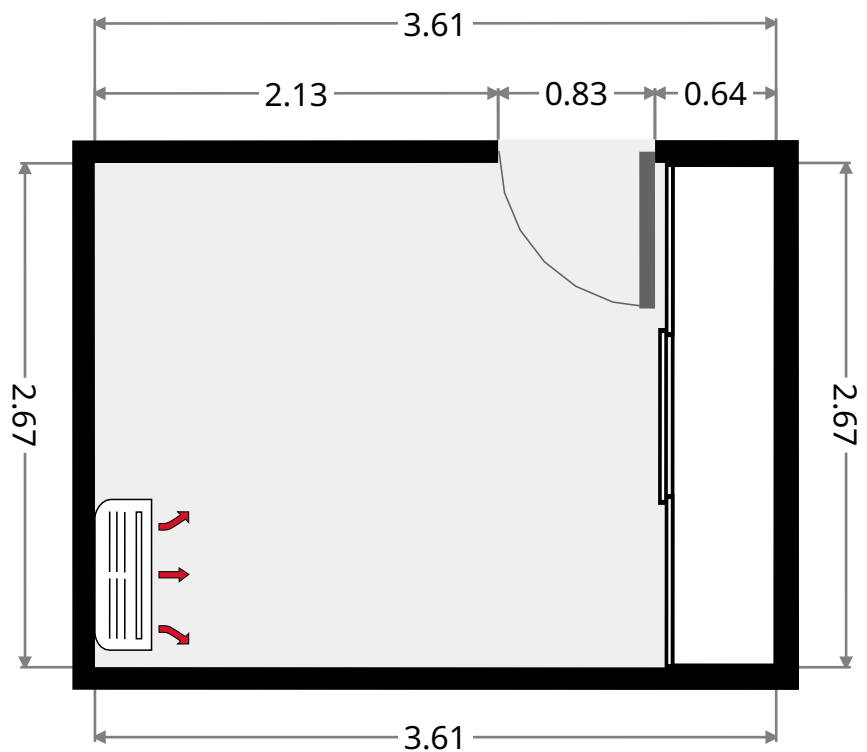
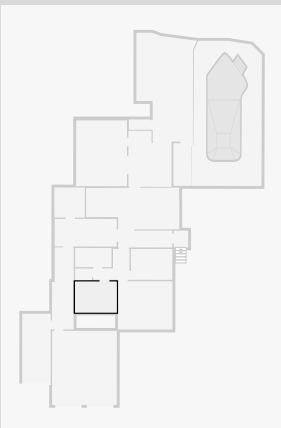

THIS FLOORPLAN IS PROVIDED WITHOUT WARRANTY OF ANY KIND. SENSOPIA DISCLAIMS ANY WARRANTY INCLUDING, WITHOUT LIMITATION, SATISFACTORY QUALITY OR ACCURACY OF DIMENSIONS.

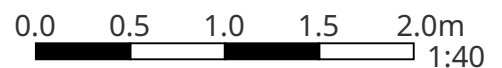

363 Lawrence Avenue

Master Bedroom

Width: 4.18 m
Length: 4.71 m
Area: 19.68 m²
Perimeter: 17.78 m

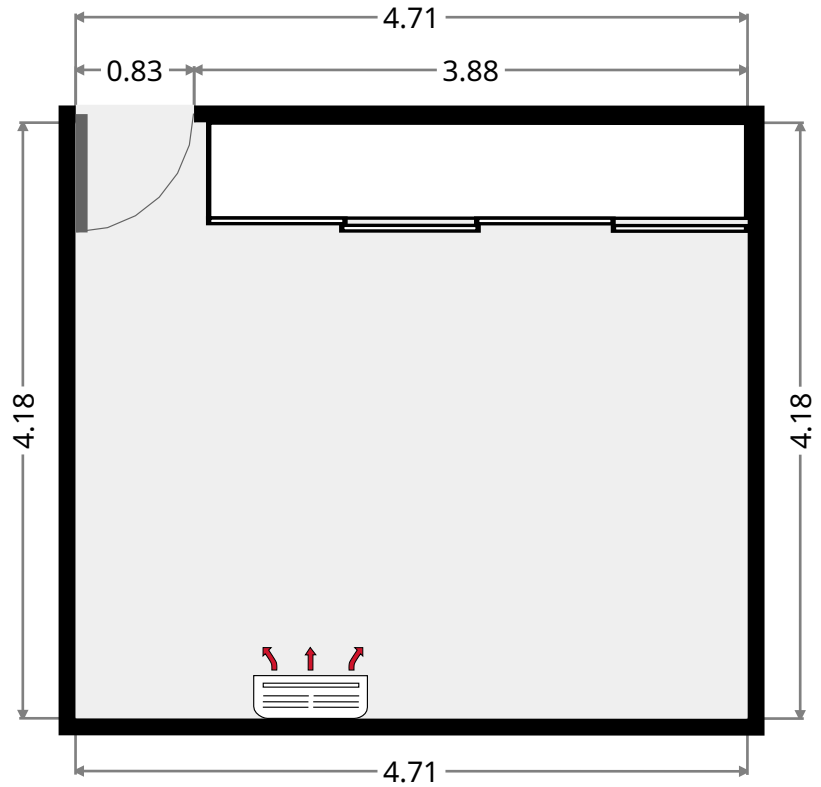
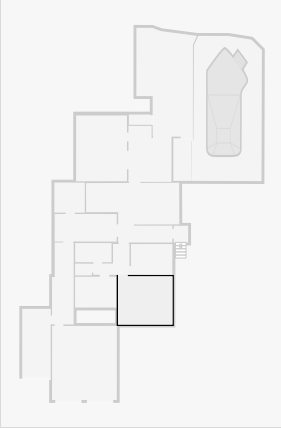

Bedroom

Width: 2.67 m
Length: 3.59 m
Area: 9.59 m²
Perimeter: 12.52 m

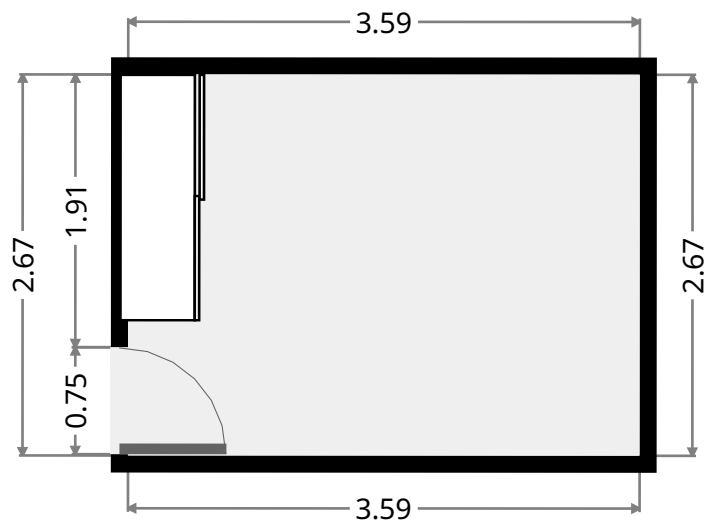
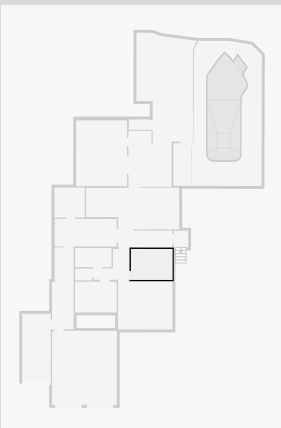

363 Lawrence Avenue

Hall

Width: 2.66 m
 Length: 3.14 m
 Area: 5.49 m²
 Perimeter: 11.62 m

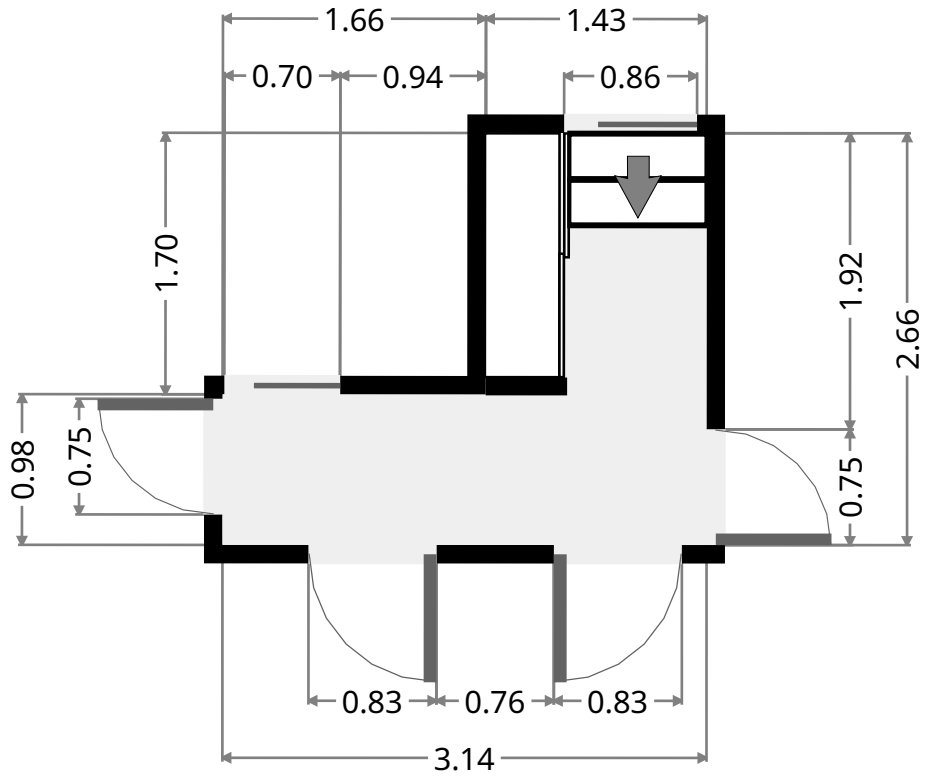
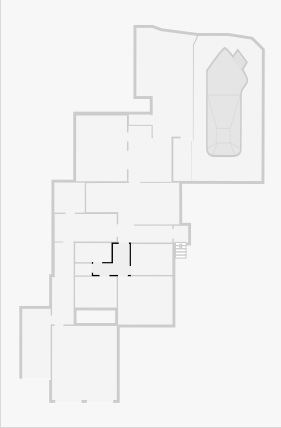

Laundry Room

Width: 1.65 m
 Length: 2.90 m
 Area: 4.77 m²
 Perimeter: 9.08 m

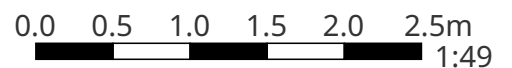
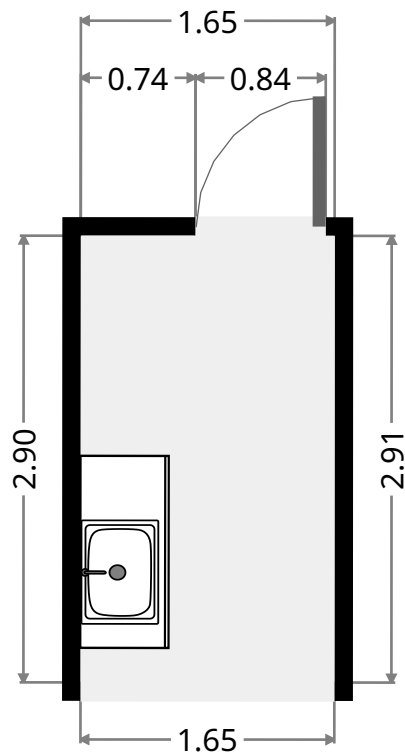
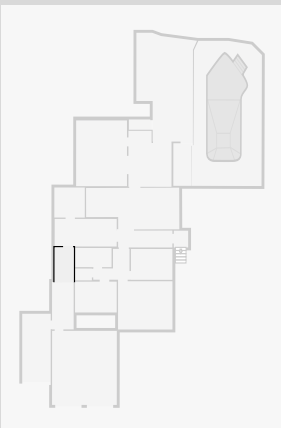

THIS FLOORPLAN IS PROVIDED WITHOUT WARRANTY OF ANY KIND. SENSOPIA DISCLAIMS ANY WARRANTY INCLUDING, WITHOUT LIMITATION, SATISFACTORY QUALITY OR ACCURACY OF DIMENSIONS.

363 Lawrence Avenue

Study

Width: 2.60 m
Length: 2.64 m
Area: 6.86 m²
Perimeter: 10.48 m

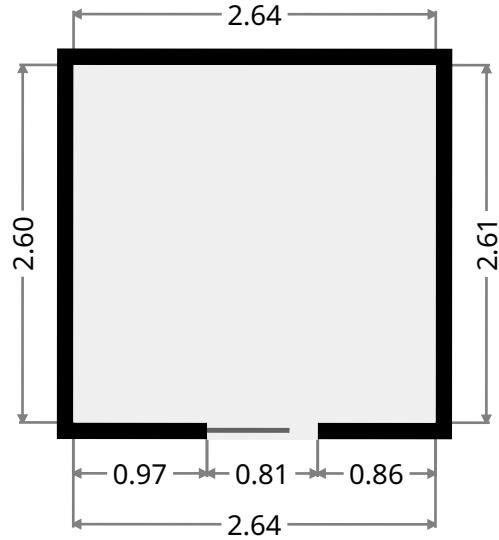
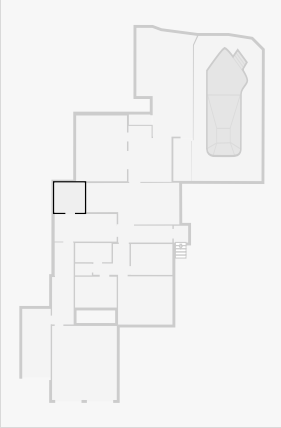

Kitchen

Width: 2.39 m
Length: 5.37 m
Area: 12.83 m²
Perimeter: 15.52 m

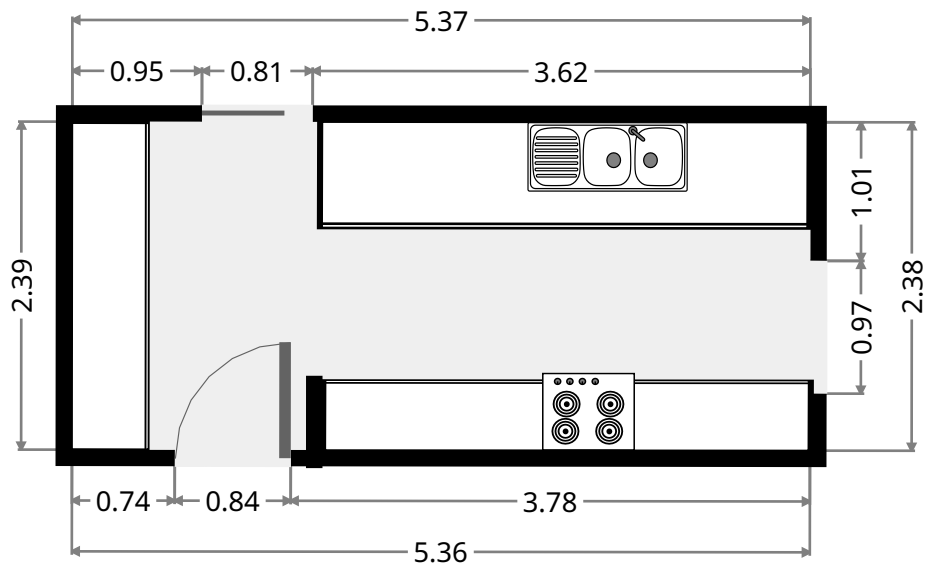
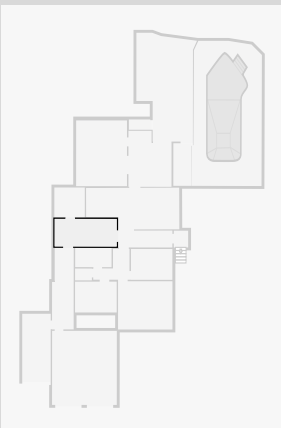

363 Lawrence Avenue

Living Room

Width: 3.61 m
Length: 8.07 m
Area: 26.08 m²
Perimeter: 23.34 m

