

# Ground Floor

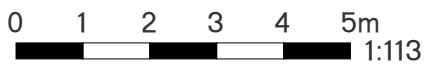
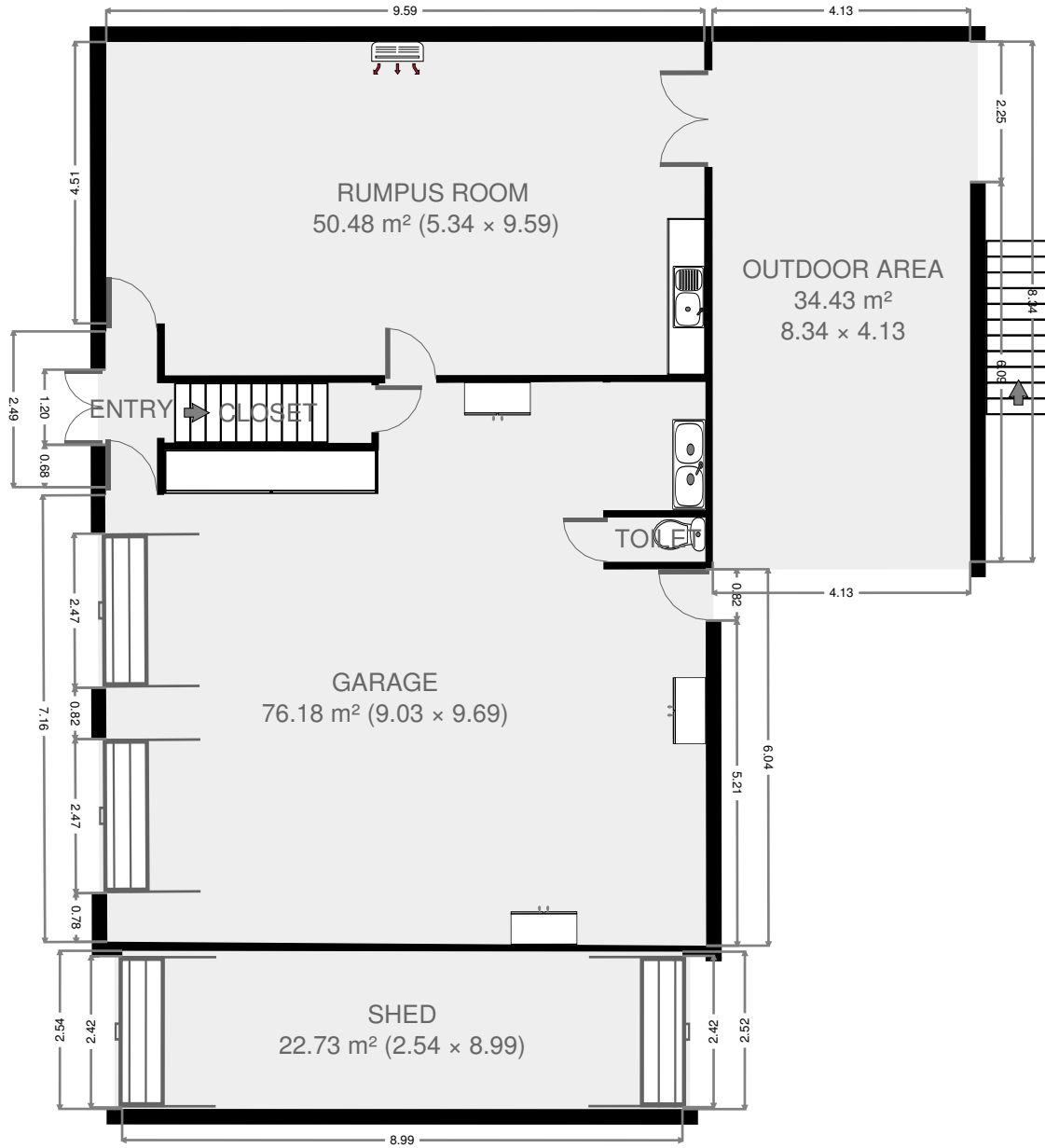

## 34 Scott Street

THIS FLOORPLAN IS PROVIDED WITHOUT WARRANTY OF ANY KIND. SENSOPIA DISCLAIMS ANY WARRANTY INCLUDING, WITHOUT LIMITATION, SATISFACTORY QUALITY OR ACCURACY OF DIMENSIONS.

# Garage

Width: 9.03 m  
 Length: 9.69 m  
 Area: 76.18 m<sup>2</sup>  
 Perimeter: 37.23 m

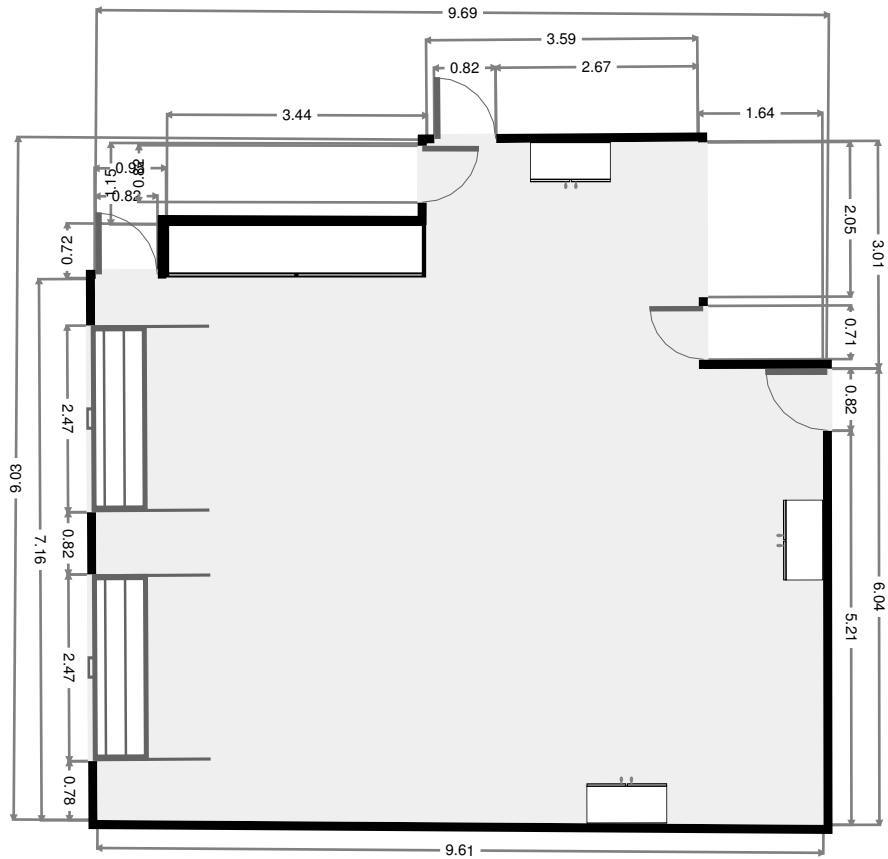
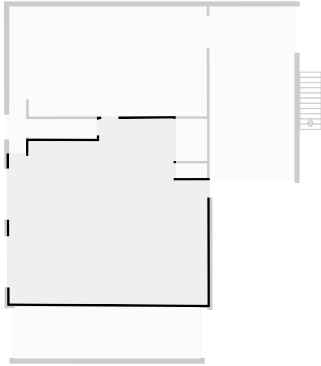

# Laundry Room

Width: 1.53 m  
 Length: 2.05 m  
 Area: 3.13 m<sup>2</sup>  
 Perimeter: 7.16 m

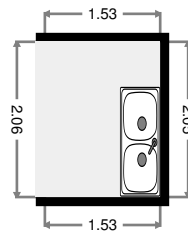
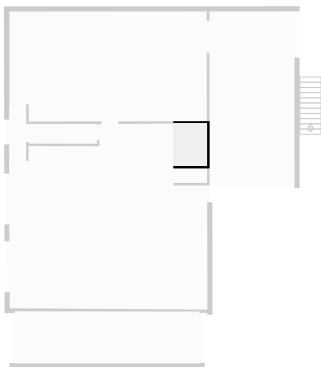

THIS FLOORPLAN IS PROVIDED WITHOUT WARRANTY OF ANY KIND. SENSOPIA DISCLAIMS ANY WARRANTY INCLUDING, WITHOUT LIMITATION, SATISFACTORY QUALITY OR ACCURACY OF DIMENSIONS.



# Toilet

Width: 0.71 m  
 Length: 1.51 m  
 Area: 1.07 m<sup>2</sup>  
 Perimeter: 4.45 m

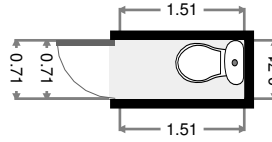
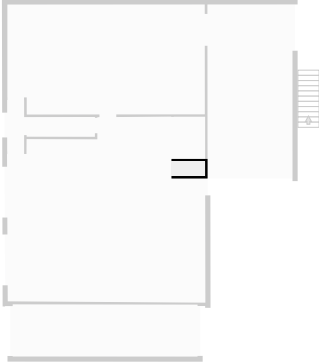

# Rumpus Room

Width: 5.34 m  
 Length: 9.59 m  
 Area: 50.48 m<sup>2</sup>  
 Perimeter: 29.87 m

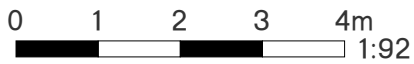
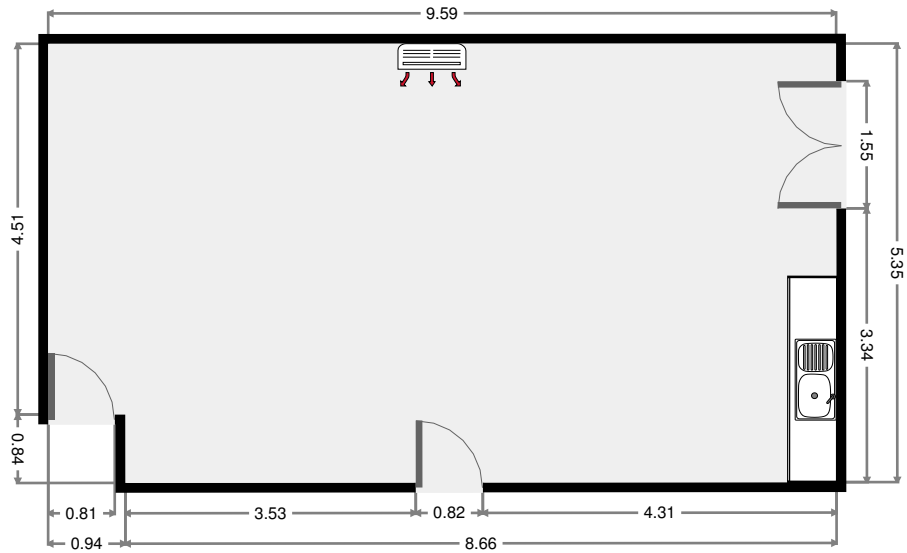
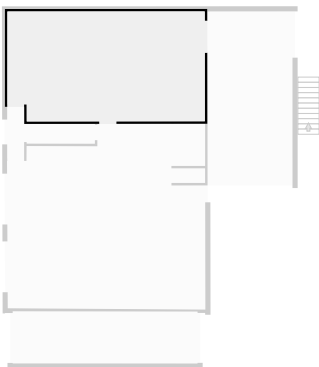

THIS FLOORPLAN IS PROVIDED WITHOUT WARRANTY OF ANY KIND. SENSOPIA DISCLAIMS ANY WARRANTY INCLUDING, WITHOUT LIMITATION, SATISFACTORY QUALITY OR ACCURACY OF DIMENSIONS.

# Entry

Width: 0.82 m  
 Length: 2.50 m  
 Area: 2.06 m<sup>2</sup>  
 Perimeter: 6.64 m

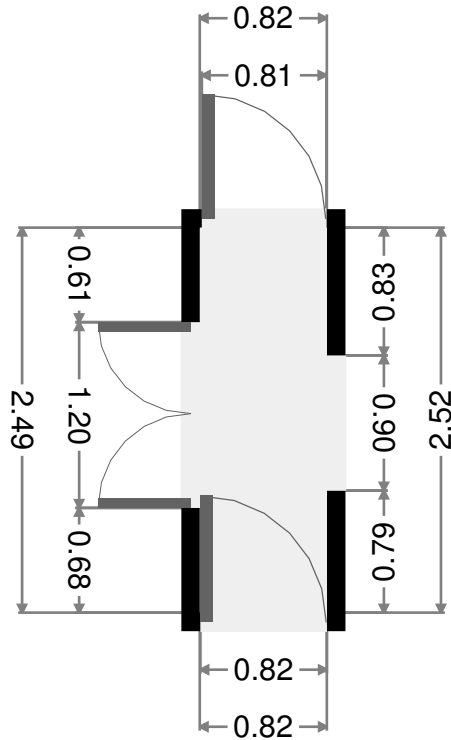
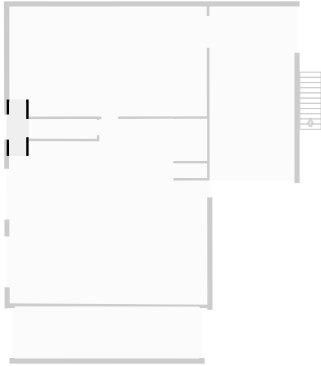

# Closet

Width: 0.96 m  
 Length: 3.32 m  
 Area: 3.18 m<sup>2</sup>  
 Perimeter: 8.55 m

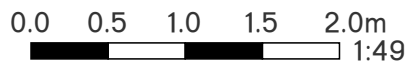
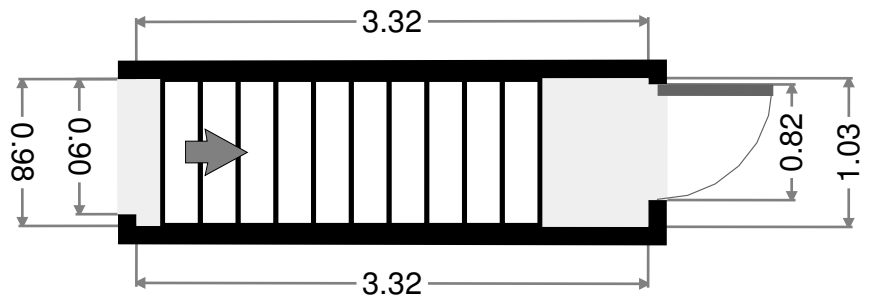
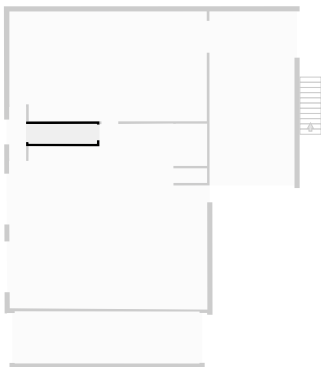

THIS FLOORPLAN IS PROVIDED WITHOUT WARRANTY OF ANY KIND. SENSOPIA DISCLAIMS ANY WARRANTY INCLUDING, WITHOUT LIMITATION, SATISFACTORY QUALITY OR ACCURACY OF DIMENSIONS.

# Outdoor Area

Width: 4.13 m  
 Length: 8.34 m  
 Area: 34.43 m<sup>2</sup>  
 Perimeter: 24.93 m

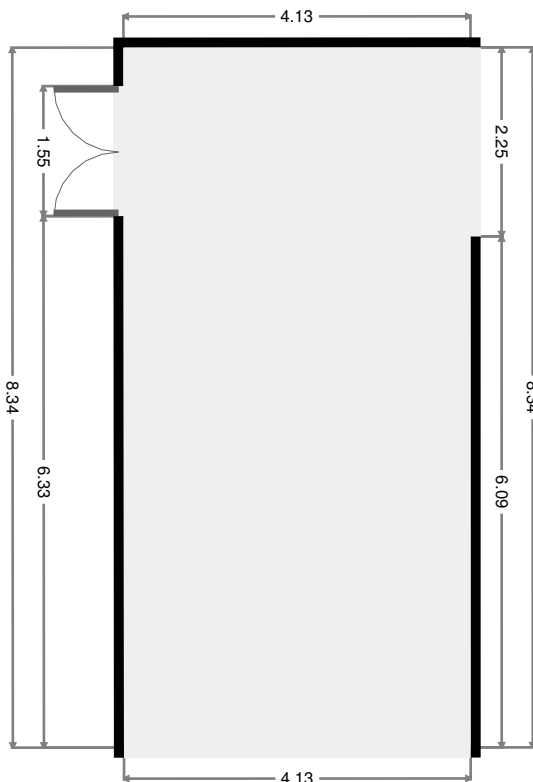
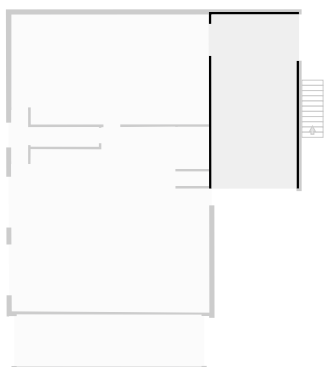

# Shed

Width: 2.54 m  
 Length: 8.99 m  
 Area: 22.73 m<sup>2</sup>  
 Perimeter: 23.03 m

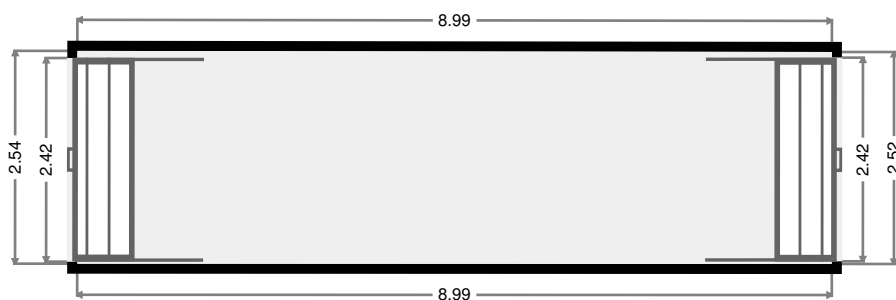
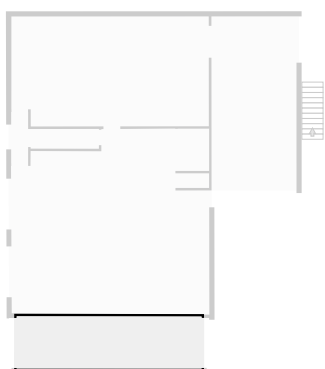

THIS FLOORPLAN IS PROVIDED WITHOUT WARRANTY OF ANY KIND. SENSOPIA DISCLAIMS ANY WARRANTY INCLUDING, WITHOUT LIMITATION, SATISFACTORY QUALITY OR ACCURACY OF DIMENSIONS.

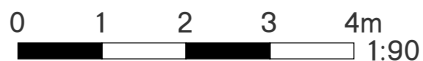

## 34 Scott Street

2017-05-09

# 1st Floor

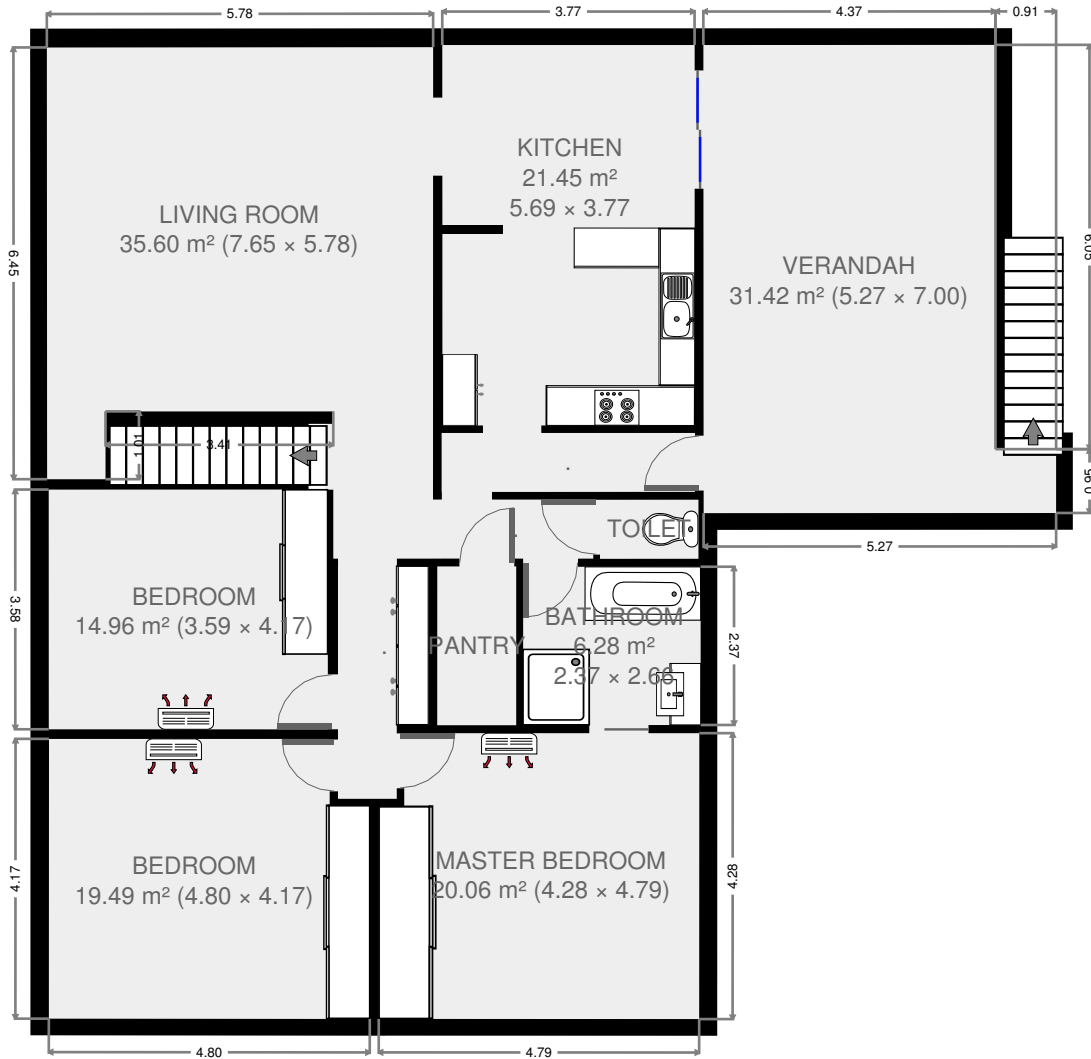

THIS FLOORPLAN IS PROVIDED WITHOUT WARRANTY OF ANY KIND. SENSOPIA DISCLAIMS ANY WARRANTY INCLUDING, WITHOUT LIMITATION, SATISFACTORY QUALITY OR ACCURACY OF DIMENSIONS.

## 34 Scott Street

# Living Room

Width: 5.78 m  
 Length: 7.65 m  
 Area: 35.60 m<sup>2</sup>  
 Perimeter: 28.86 m

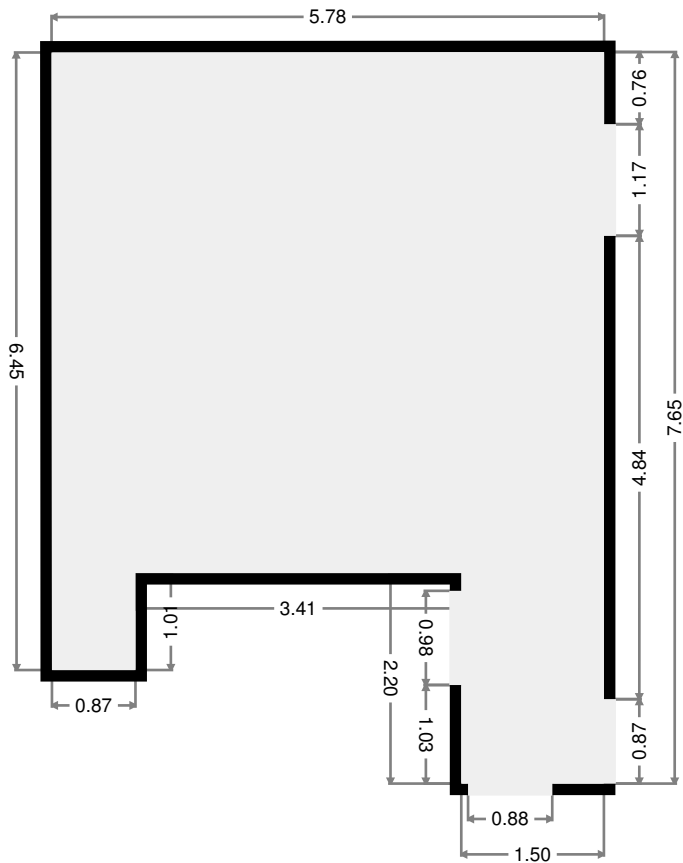
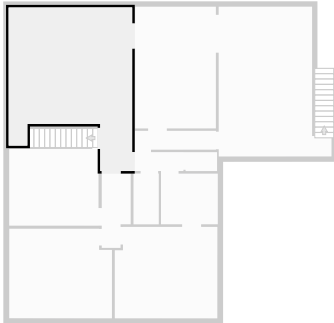

# Kitchen

Width: 3.77 m  
 Length: 5.69 m  
 Area: 21.45 m<sup>2</sup>  
 Perimeter: 18.92 m

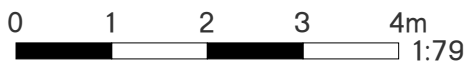
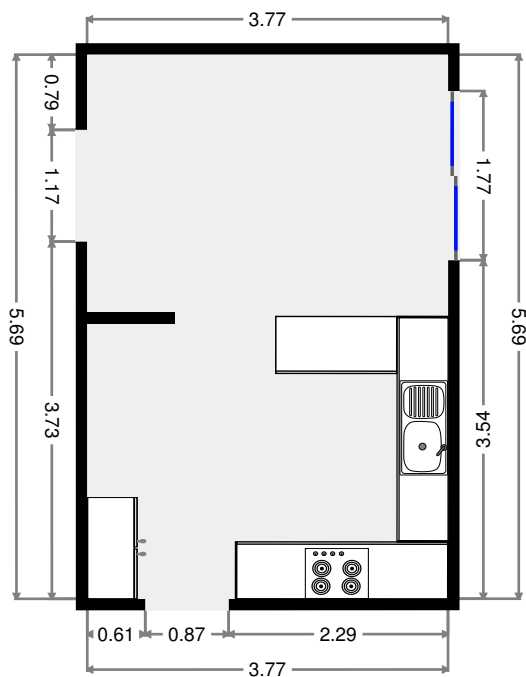
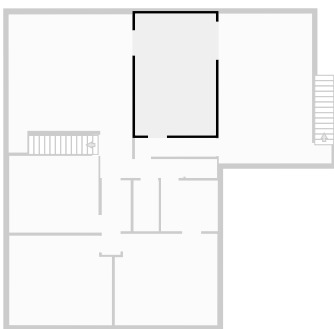

THIS FLOORPLAN IS PROVIDED WITHOUT WARRANTY OF ANY KIND. SENSOPIA DISCLAIMS ANY WARRANTY INCLUDING, WITHOUT LIMITATION, SATISFACTORY QUALITY OR ACCURACY OF DIMENSIONS.

- Width: 0.88 m  
 Length: 3.78 m  
 Area: 3.34 m<sup>2</sup>  
 Perimeter: 9.34 m

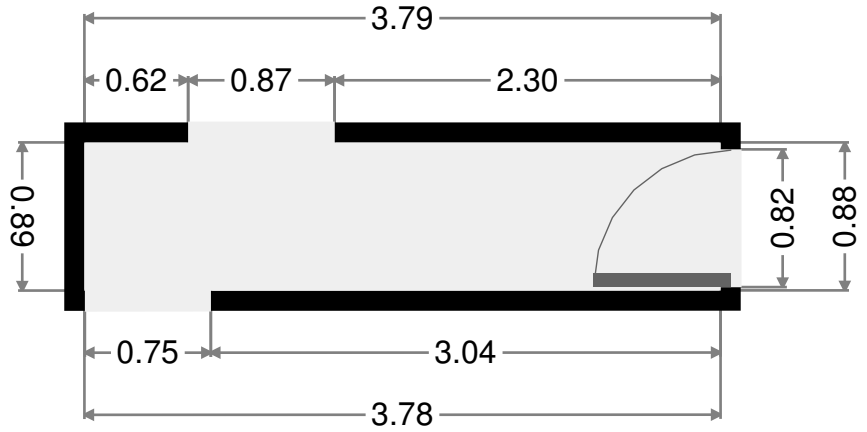
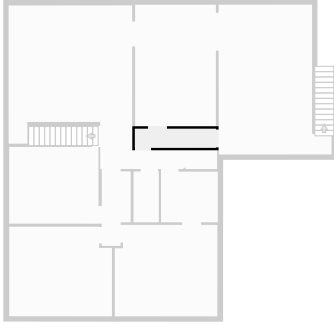

- Width: 0.88 m  
 Length: 2.32 m  
 Area: 2.04 m<sup>2</sup>  
 Perimeter: 6.39 m

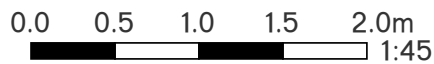
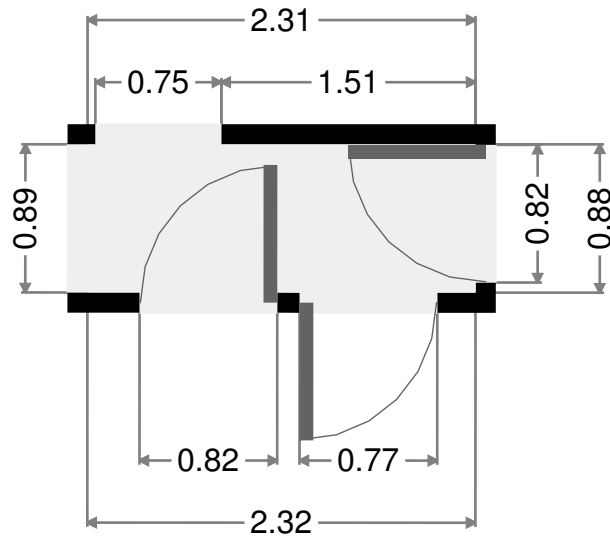
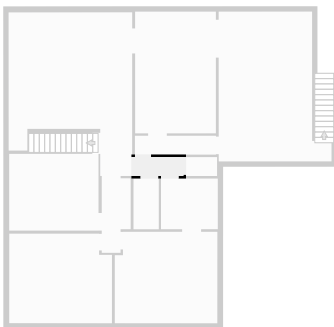

THIS FLOORPLAN IS PROVIDED WITHOUT WARRANTY OF ANY KIND. SENSOPIA DISCLAIMS ANY WARRANTY INCLUDING, WITHOUT LIMITATION, SATISFACTORY QUALITY OR ACCURACY OF DIMENSIONS.

# 34 Scott Street

2017-05-09



# Toilet

Width: 0.88 m  
Length: 1.48 m  
Area: 1.30 m<sup>2</sup>  
Perimeter: 4.71 m

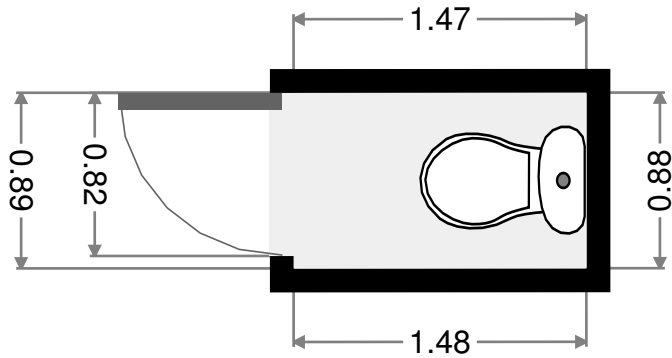
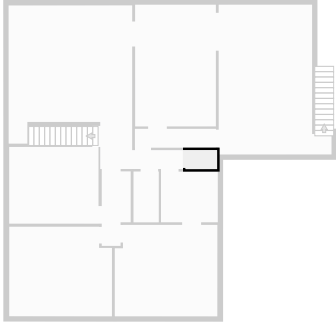

# Bathroom

Width: 2.37 m  
Length: 2.66 m  
Area: 6.28 m<sup>2</sup>  
Perimeter: 10.04 m

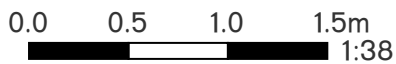
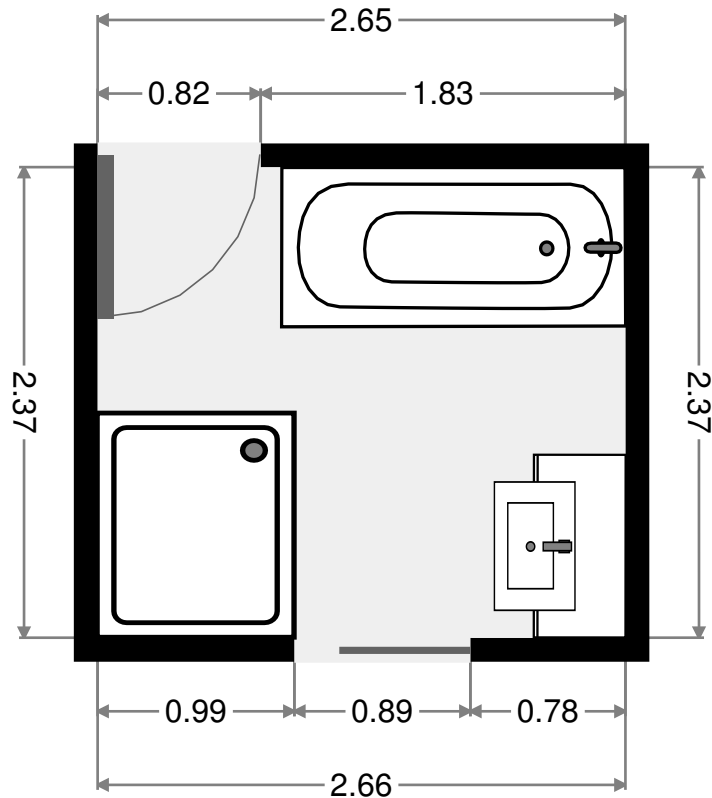
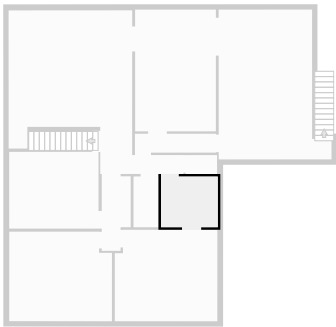

THIS FLOORPLAN IS PROVIDED WITHOUT WARRANTY OF ANY KIND. SENSOPIA DISCLAIMS ANY WARRANTY INCLUDING, WITHOUT LIMITATION, SATISFACTORY QUALITY OR ACCURACY OF DIMENSIONS.

# Pantry

Width: 1.19 m  
 Length: 2.37 m  
 Area: 2.80 m<sup>2</sup>  
 Perimeter: 7.11 m

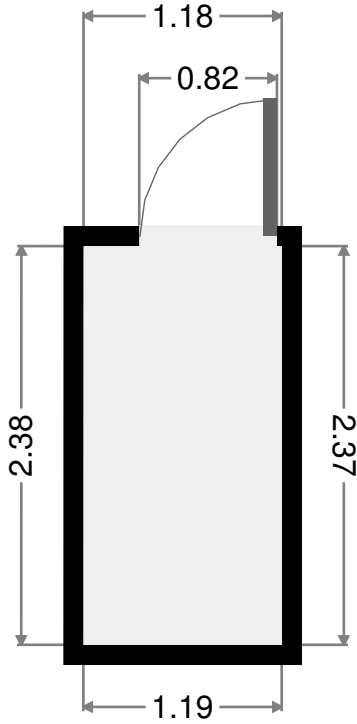
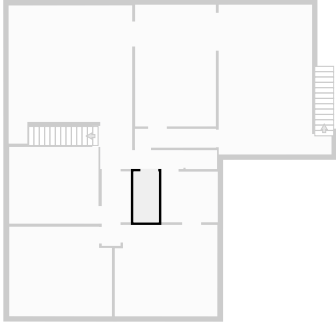

•  
 Width: 1.34 m  
 Length: 3.49 m  
 Area: 4.19 m<sup>2</sup>  
 Perimeter: 9.67 m

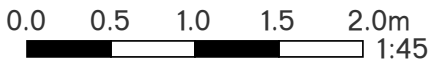
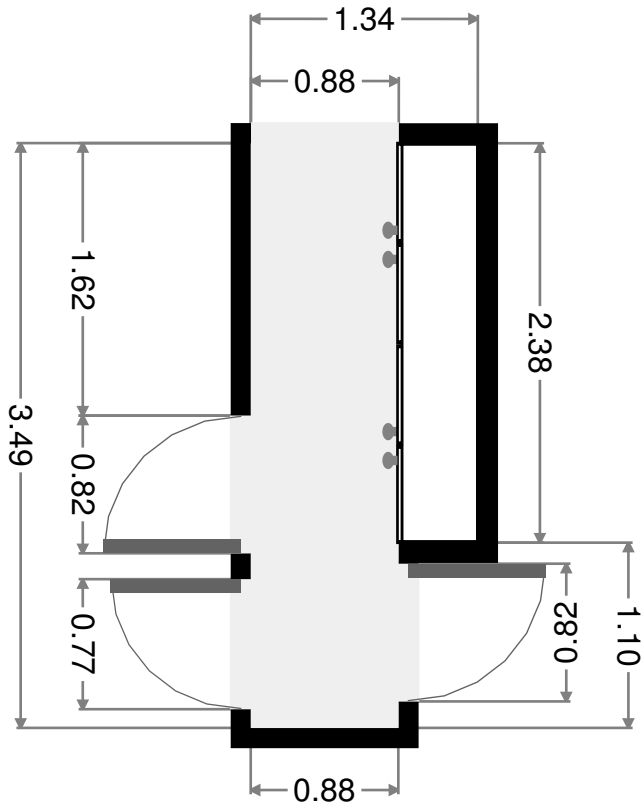
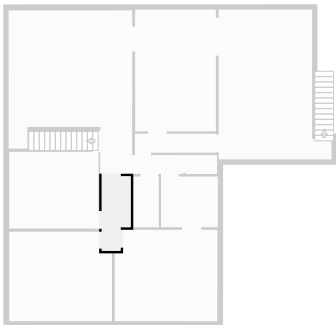

THIS FLOORPLAN IS PROVIDED WITHOUT WARRANTY OF ANY KIND. SENSOPIA DISCLAIMS ANY WARRANTY INCLUDING, WITHOUT LIMITATION, SATISFACTORY QUALITY OR ACCURACY OF DIMENSIONS.

# Master Bedroom

Width: 4.28 m  
Length: 4.79 m  
Area: 20.06 m<sup>2</sup>  
Perimeter: 18.13 m

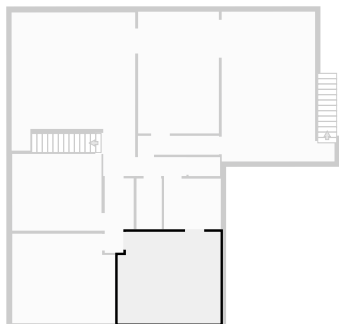
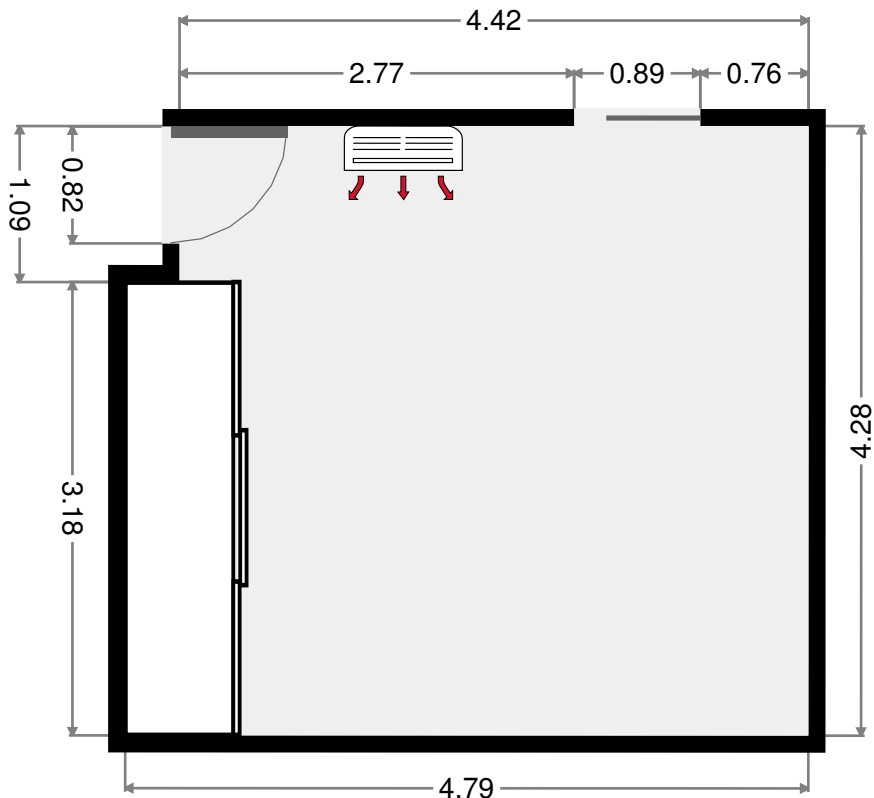

# Bedroom

Width: 4.17 m  
Length: 4.80 m  
Area: 19.49 m<sup>2</sup>  
Perimeter: 17.97 m

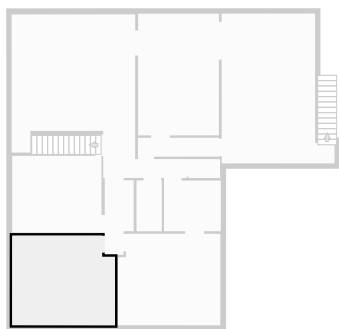
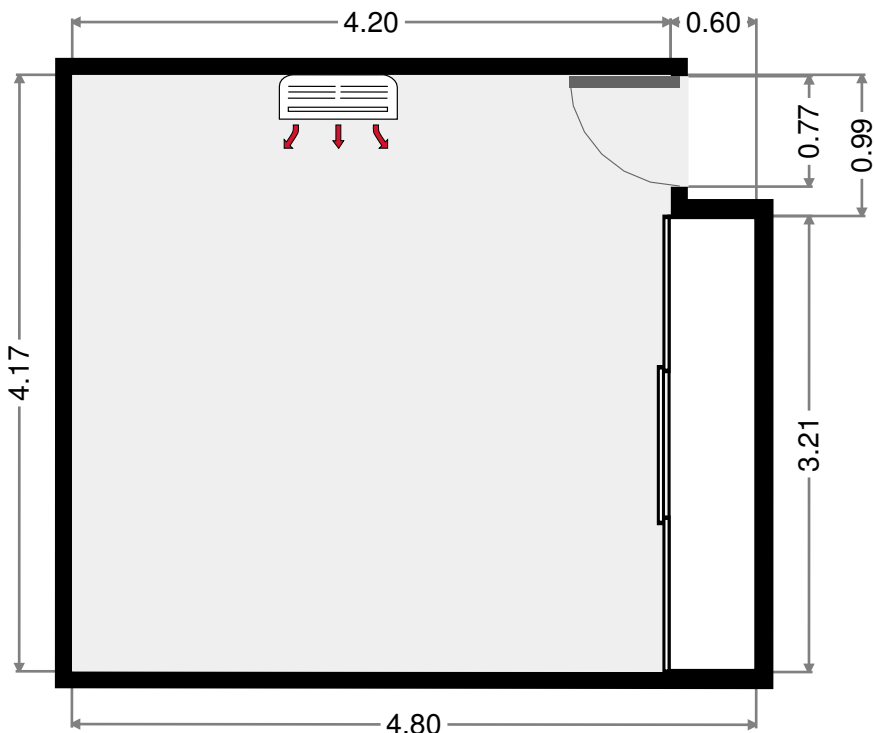

THIS FLOORPLAN IS PROVIDED WITHOUT WARRANTY OF ANY KIND. SENSOPIA DISCLAIMS ANY WARRANTY INCLUDING, WITHOUT LIMITATION, SATISFACTORY QUALITY OR ACCURACY OF DIMENSIONS.

# Bedroom

Width: 3.59 m  
 Length: 4.17 m  
 Area: 14.96 m<sup>2</sup>  
 Perimeter: 15.52 m

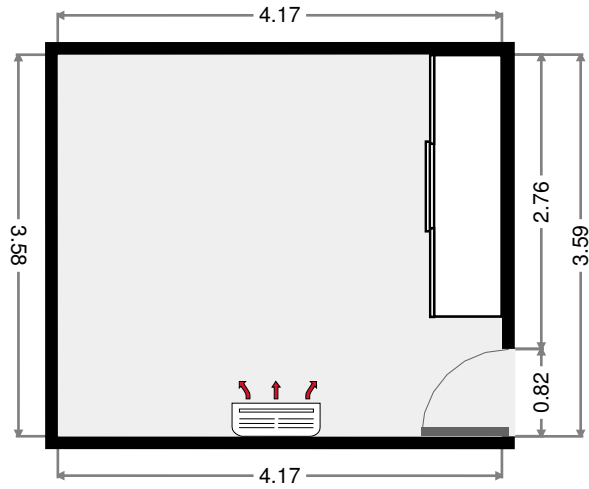
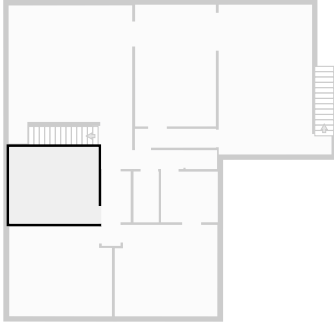

# Verandah

Width: 5.27 m  
 Length: 7.00 m  
 Area: 31.42 m<sup>2</sup>  
 Perimeter: 24.54 m

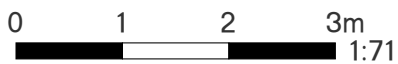
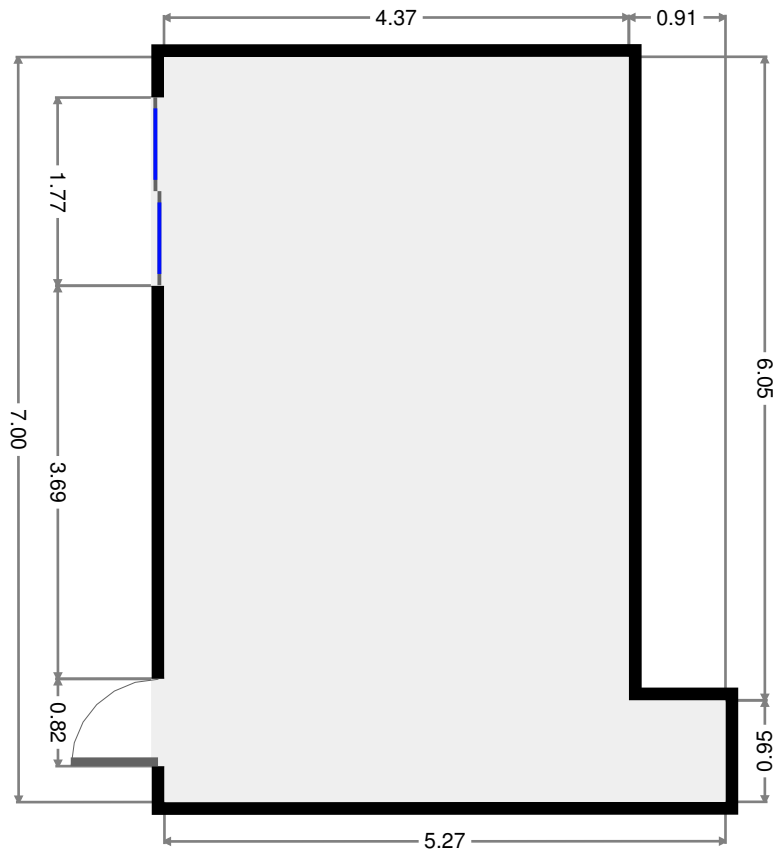
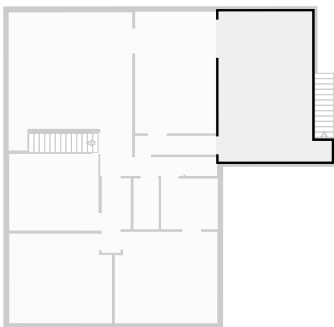

THIS FLOORPLAN IS PROVIDED WITHOUT WARRANTY OF ANY KIND. SENSOPIA DISCLAIMS ANY WARRANTY INCLUDING, WITHOUT LIMITATION, SATISFACTORY QUALITY OR ACCURACY OF DIMENSIONS.