

# 34 Price Drive

## Ground Floor

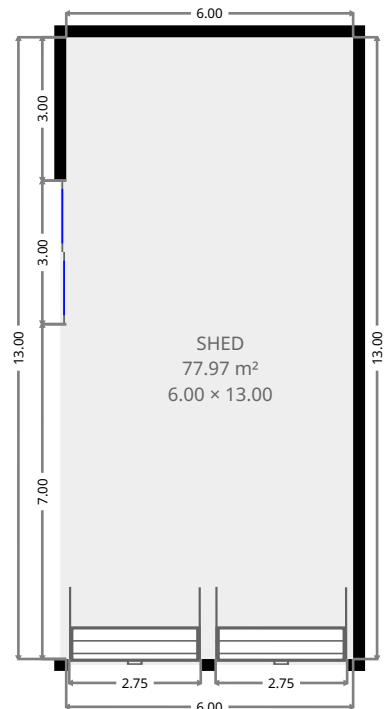

THIS FLOORPLAN IS PROVIDED WITHOUT WARRANTY OF ANY KIND. SENSOPIA DISCLAIMS ANY WARRANTY INCLUDING, WITHOUT LIMITATION, SATISFACTORY QUALITY OR ACCURACY OF DIMENSIONS.

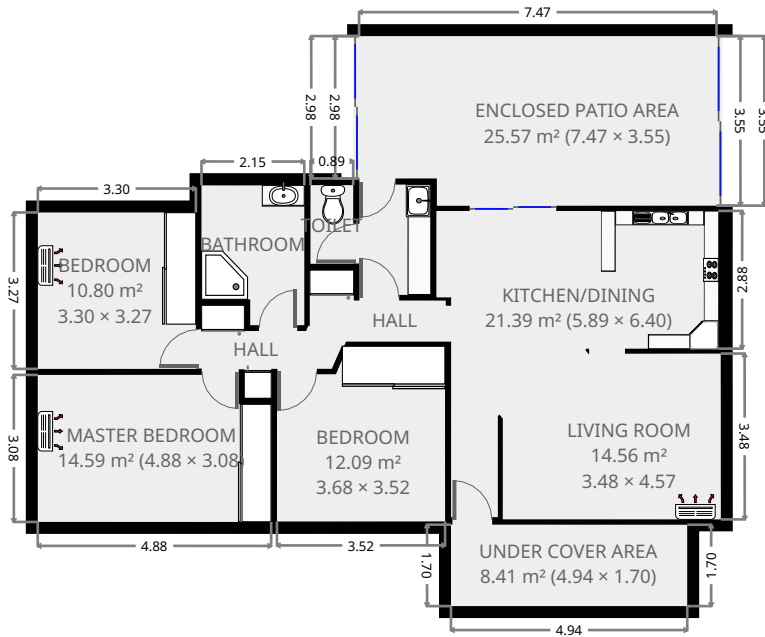
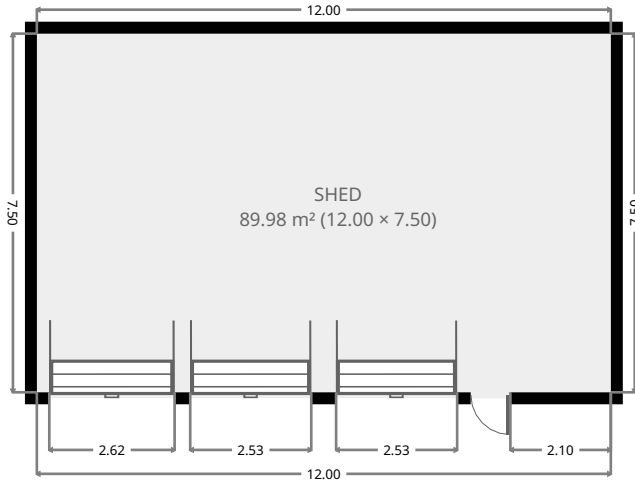

# 34 Price Drive

## Living Room

Width: 3.48 m  
 Length: 4.57 m  
 Area: 14.56 m<sup>2</sup>  
 Perimeter: 15.14 m  
 Ceiling Height: 2.17 m

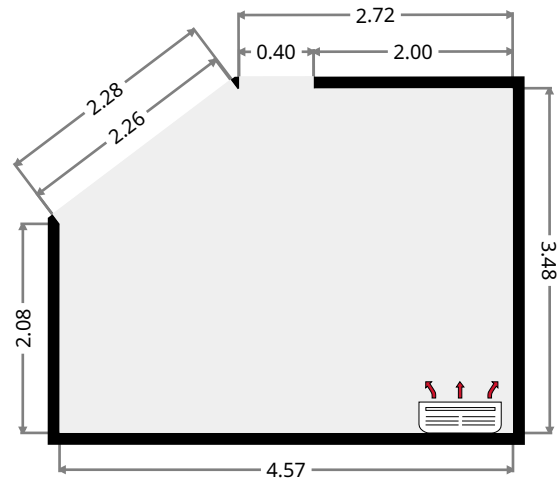
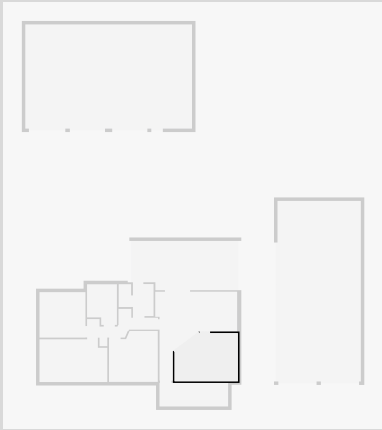

## Kitchen/Dining

Width: 5.89 m  
 Length: 6.40 m  
 Area: 21.39 m<sup>2</sup>  
 Perimeter: 23.66 m

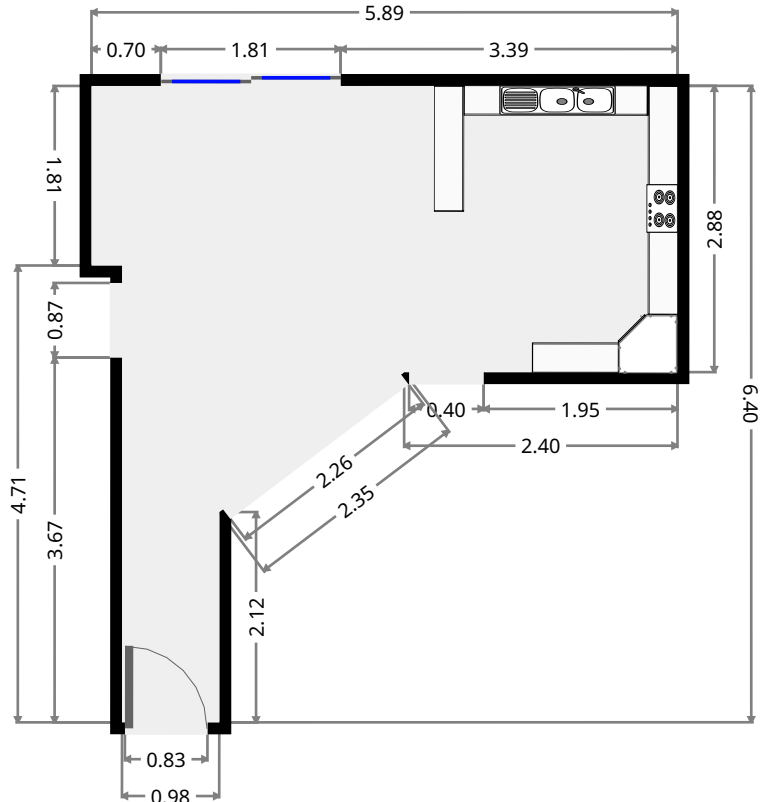
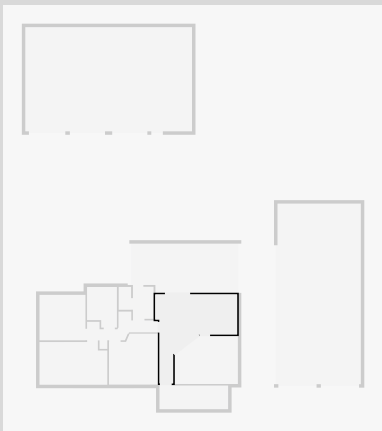

THIS FLOORPLAN IS PROVIDED WITHOUT WARRANTY OF ANY KIND. SENSOPIA DISCLAIMS ANY WARRANTY INCLUDING, WITHOUT LIMITATION, SATISFACTORY QUALITY OR ACCURACY OF DIMENSIONS.

# 34 Price Drive

## Enclosed Patio Area

Width: 3.55 m  
 Length: 7.47 m  
 Area: 25.57 m<sup>2</sup>  
 Perimeter: 22.04 m

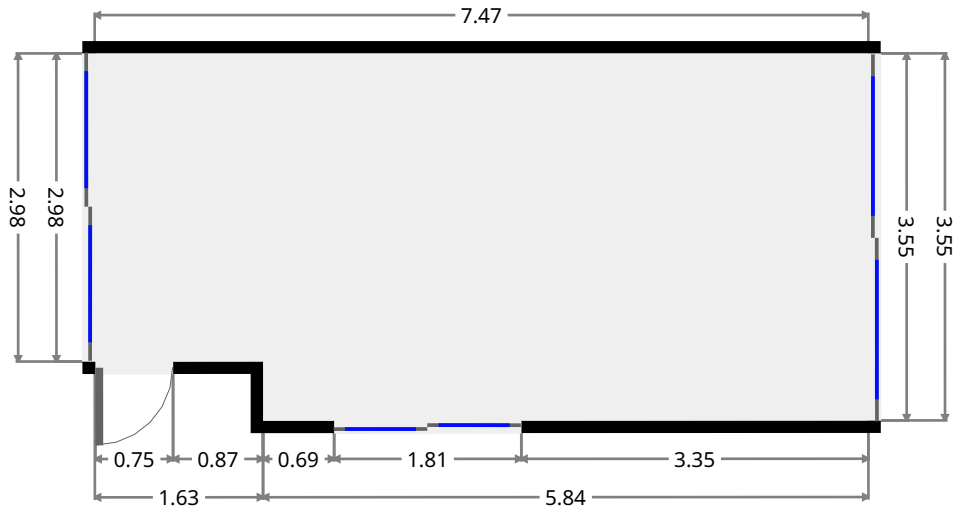
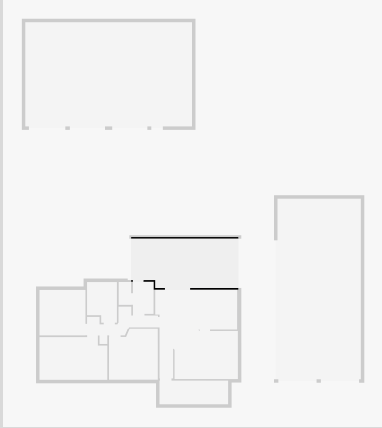

## Hall

Width: 1.50 m  
 Length: 2.84 m  
 Area: 2.90 m<sup>2</sup>  
 Perimeter: 8.42 m

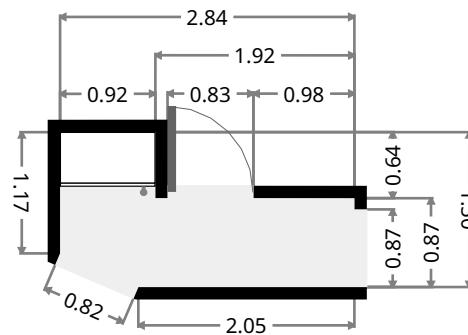
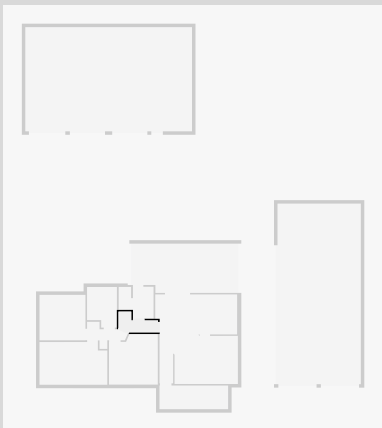

THIS FLOORPLAN IS PROVIDED WITHOUT WARRANTY OF ANY KIND. SENSOPIA DISCLAIMS ANY WARRANTY INCLUDING, WITHOUT LIMITATION, SATISFACTORY QUALITY OR ACCURACY OF DIMENSIONS.

# 34 Price Drive

## Laundry Room

Width: 1.48 m  
 Length: 2.30 m  
 Area: 3.42 m<sup>2</sup>  
 Perimeter: 7.58 m

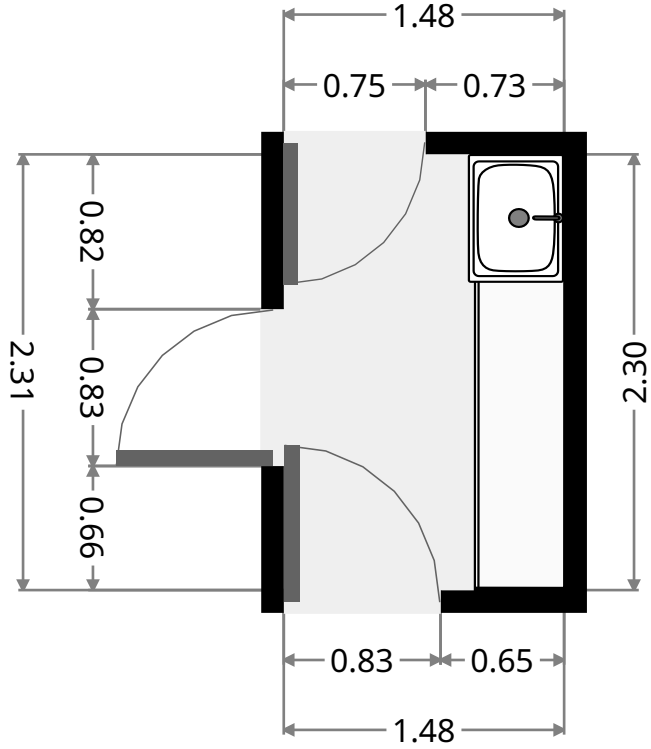
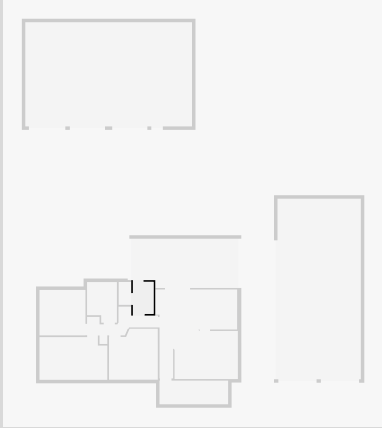

## Toilet

Width: 0.89 m  
 Length: 1.64 m  
 Area: 1.47 m<sup>2</sup>  
 Perimeter: 5.07 m

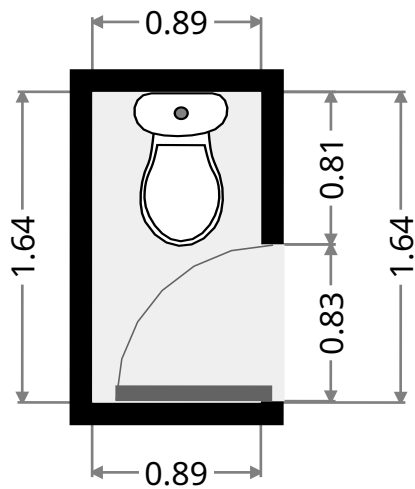
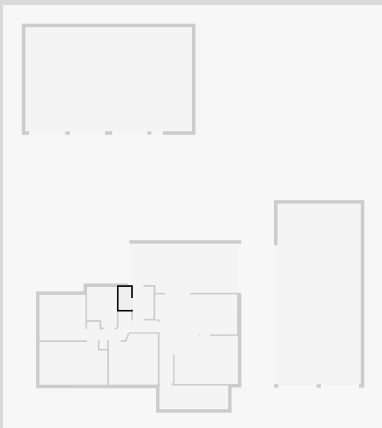

THIS FLOORPLAN IS PROVIDED WITHOUT WARRANTY OF ANY KIND. SENSOPIA DISCLAIMS ANY WARRANTY INCLUDING, WITHOUT LIMITATION, SATISFACTORY QUALITY OR ACCURACY OF DIMENSIONS.

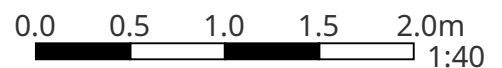

# 34 Price Drive

## Hall

Width: 1.95 m  
 Length: 2.72 m  
 Area: 2.99 m<sup>2</sup>  
 Perimeter: 9.35 m

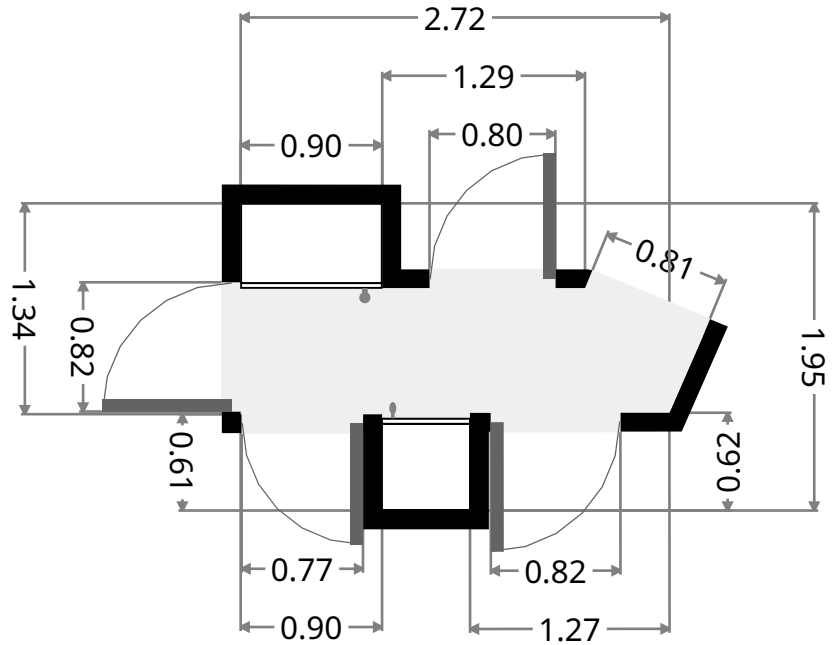
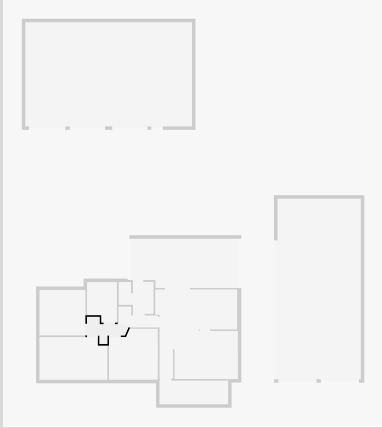

## Bedroom

Width: 3.52 m  
 Length: 3.68 m  
 Area: 12.09 m<sup>2</sup>  
 Perimeter: 14.16 m

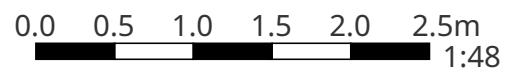
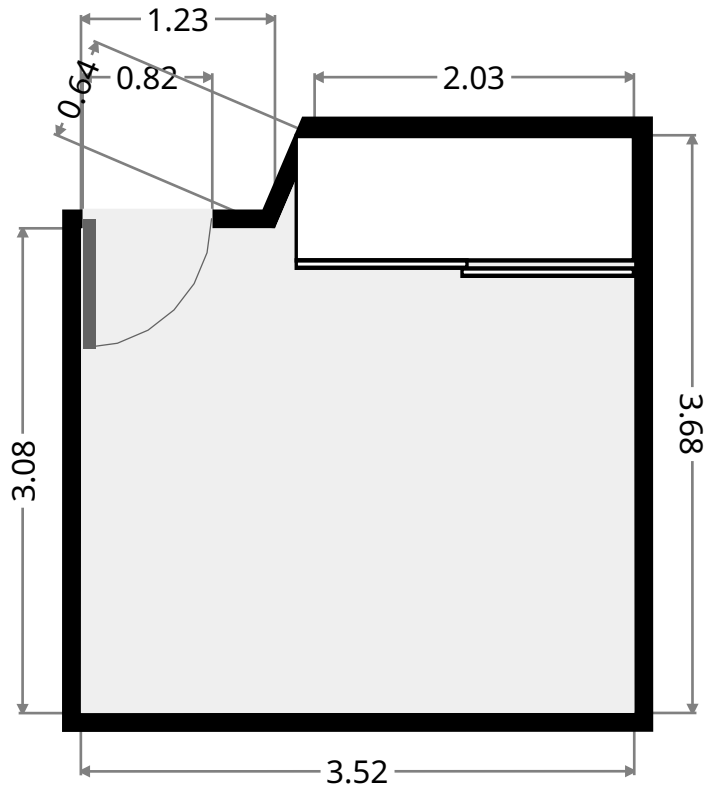
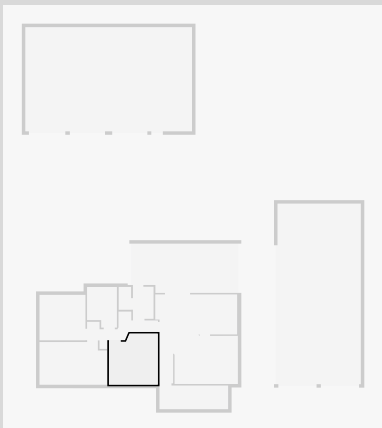

THIS FLOORPLAN IS PROVIDED WITHOUT WARRANTY OF ANY KIND. SENSOPIA DISCLAIMS ANY WARRANTY INCLUDING, WITHOUT LIMITATION, SATISFACTORY QUALITY OR ACCURACY OF DIMENSIONS.

# 34 Price Drive

## Master Bedroom

Width: 3.08 m  
 Length: 4.88 m  
 Area: 14.59 m<sup>2</sup>  
 Perimeter: 15.91 m

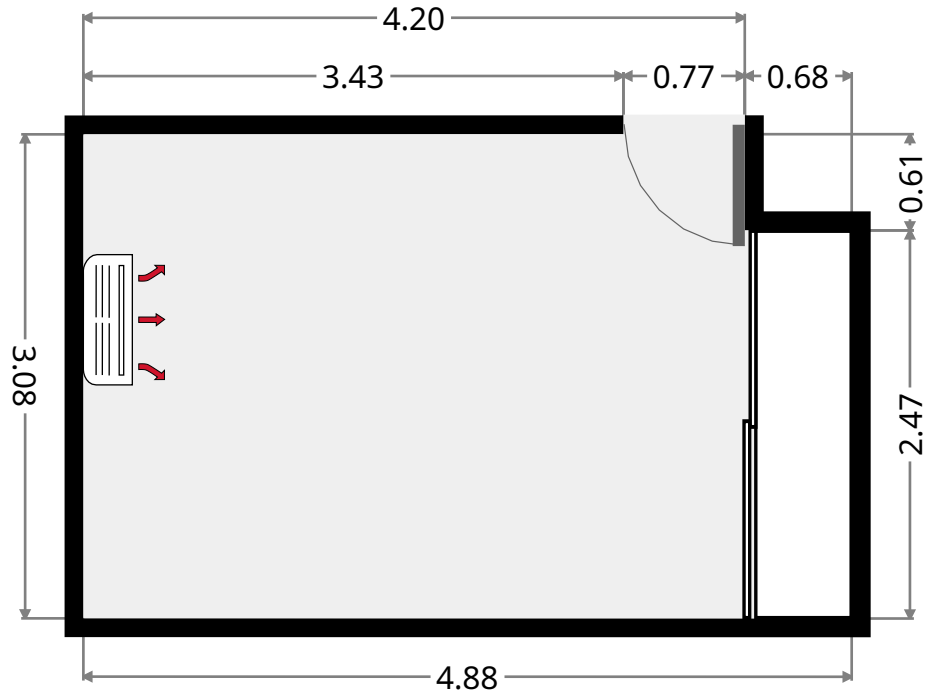
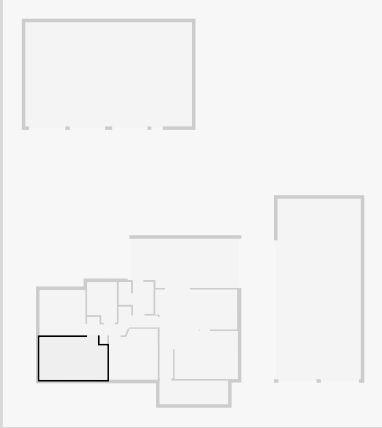

## Bedroom

Width: 3.27 m  
 Length: 3.30 m  
 Area: 10.80 m<sup>2</sup>  
 Perimeter: 13.15 m

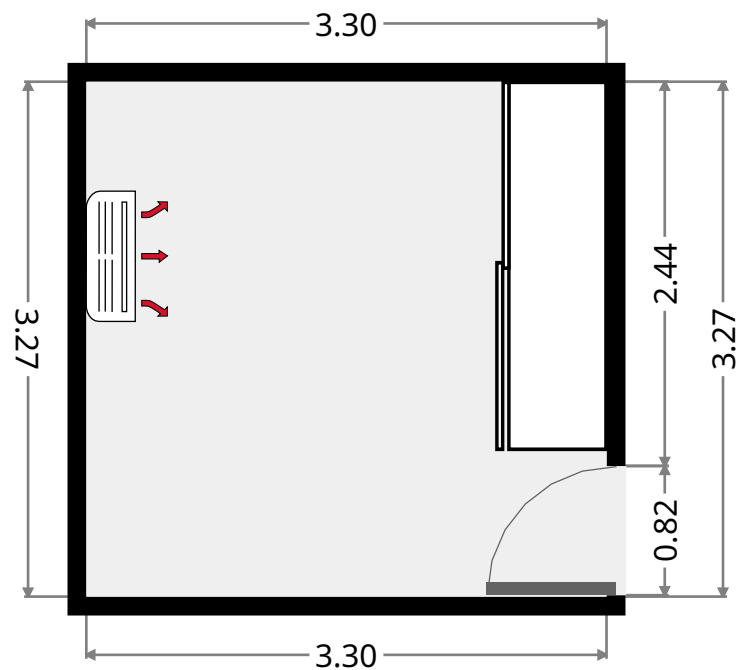
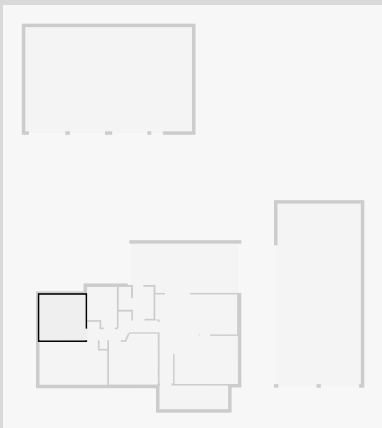

THIS FLOORPLAN IS PROVIDED WITHOUT WARRANTY OF ANY KIND. SENSOPIA DISCLAIMS ANY WARRANTY INCLUDING, WITHOUT LIMITATION, SATISFACTORY QUALITY OR ACCURACY OF DIMENSIONS.

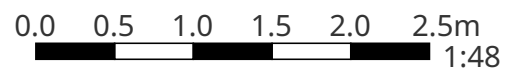

# 34 Price Drive

## Bathroom

Width: 2.15 m  
 Length: 2.92 m  
 Area: 5.73 m<sup>2</sup>  
 Perimeter: 10.14 m

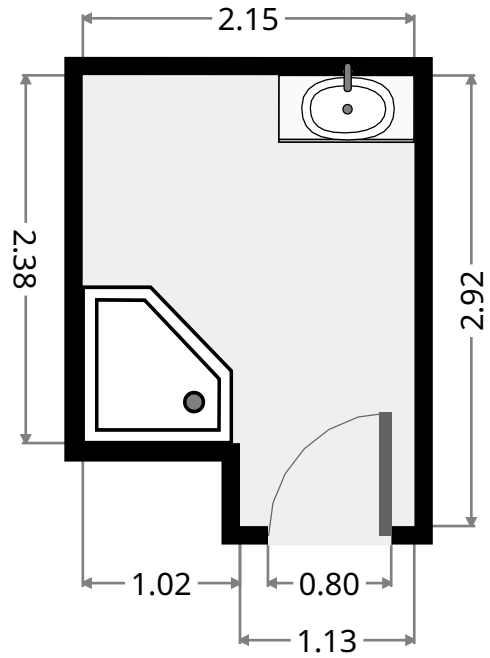
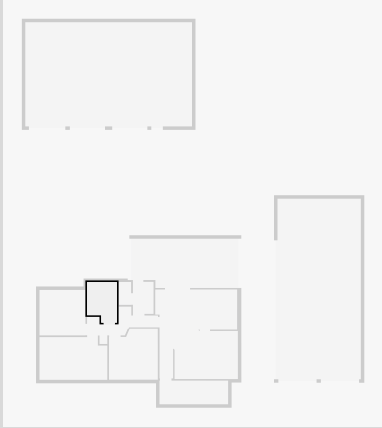

## Under cover Area

Width: 1.70 m  
 Length: 4.94 m  
 Area: 8.41 m<sup>2</sup>  
 Perimeter: 13.28 m

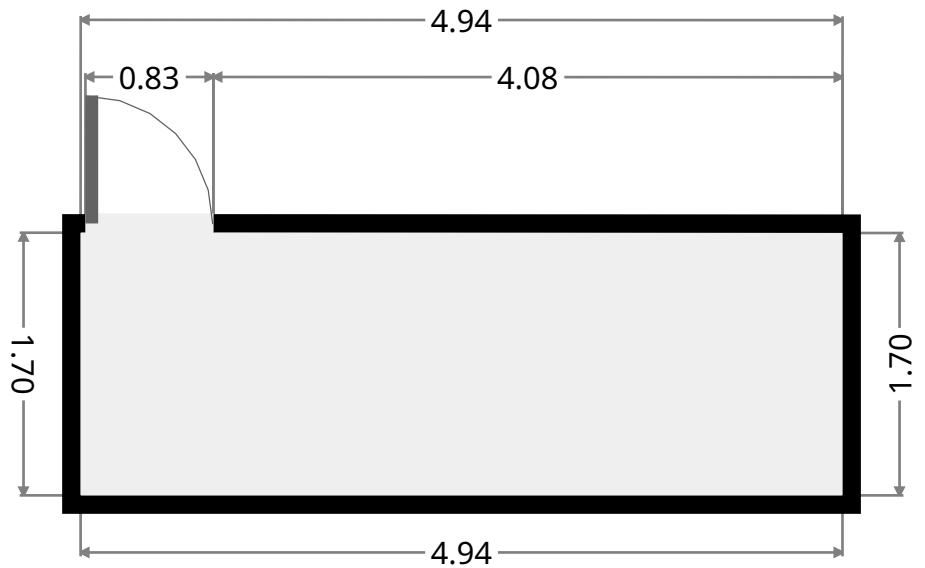
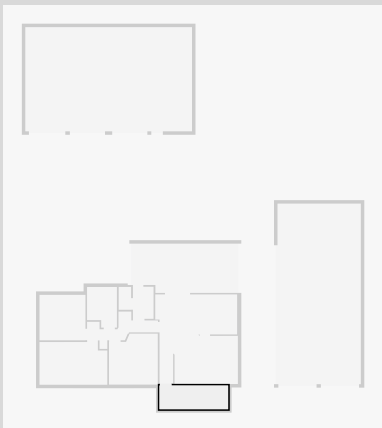

# 34 Price Drive

## Shed

Width: 6.00 m  
Length: 13.00 m  
Area: 77.97 m<sup>2</sup>  
Perimeter: 37.99 m

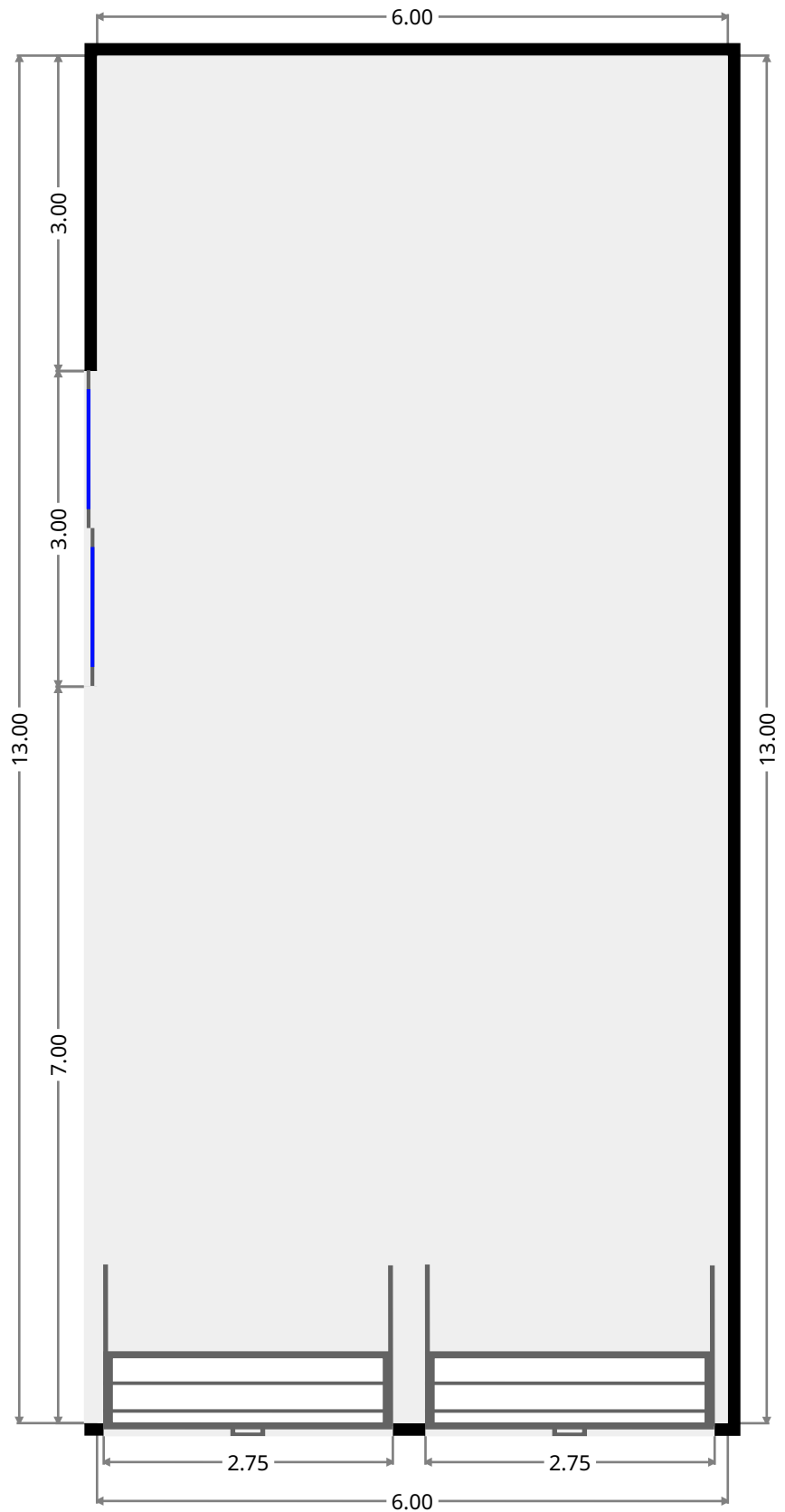
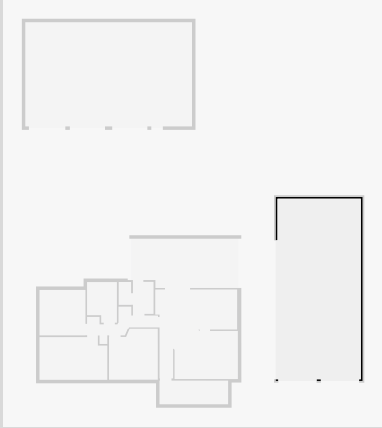

THIS FLOORPLAN IS PROVIDED WITHOUT WARRANTY OF ANY KIND. SENSOPIA DISCLAIMS ANY WARRANTY INCLUDING, WITHOUT LIMITATION, SATISFACTORY QUALITY OR ACCURACY OF DIMENSIONS.





# 34 Price Drive

## Shed

Width: 7.50 m  
Length: 12.00 m  
Area: 89.98 m<sup>2</sup>  
Perimeter: 39.00 m

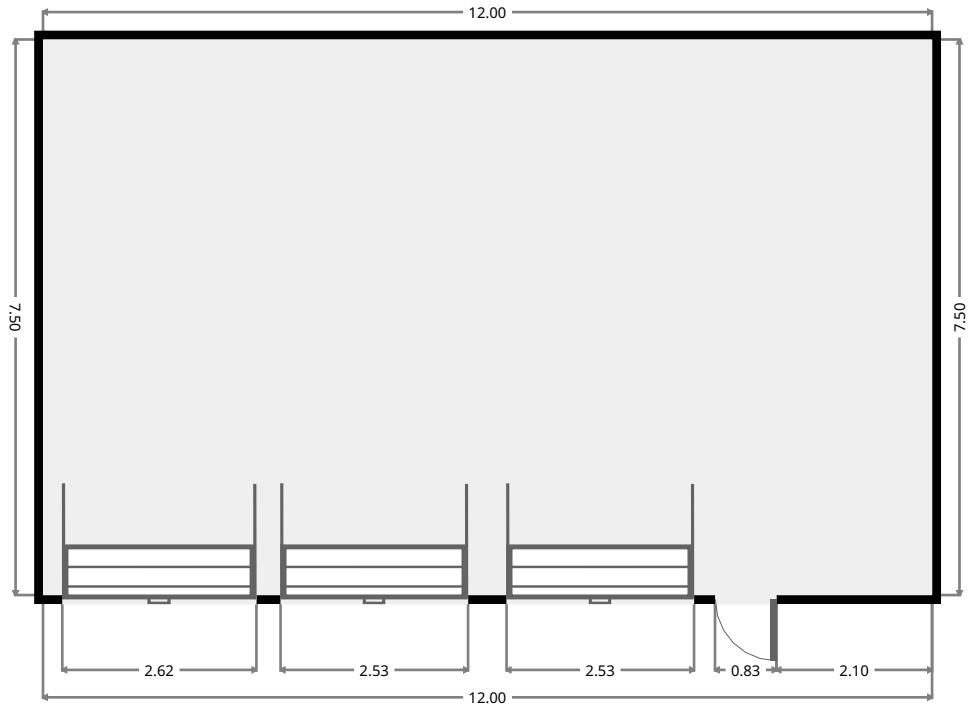
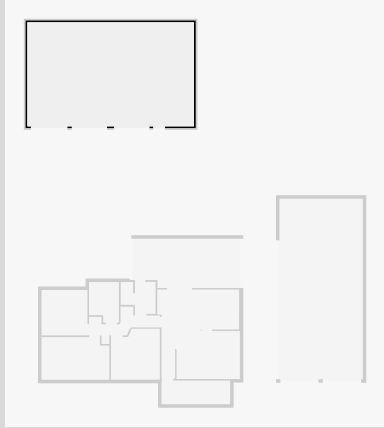

THIS FLOORPLAN IS PROVIDED WITHOUT WARRANTY OF ANY KIND. SENSOPIA DISCLAIMS ANY WARRANTY INCLUDING, WITHOUT LIMITATION, SATISFACTORY QUALITY OR ACCURACY OF DIMENSIONS.

