

327 Warnock Street

Ground Floor

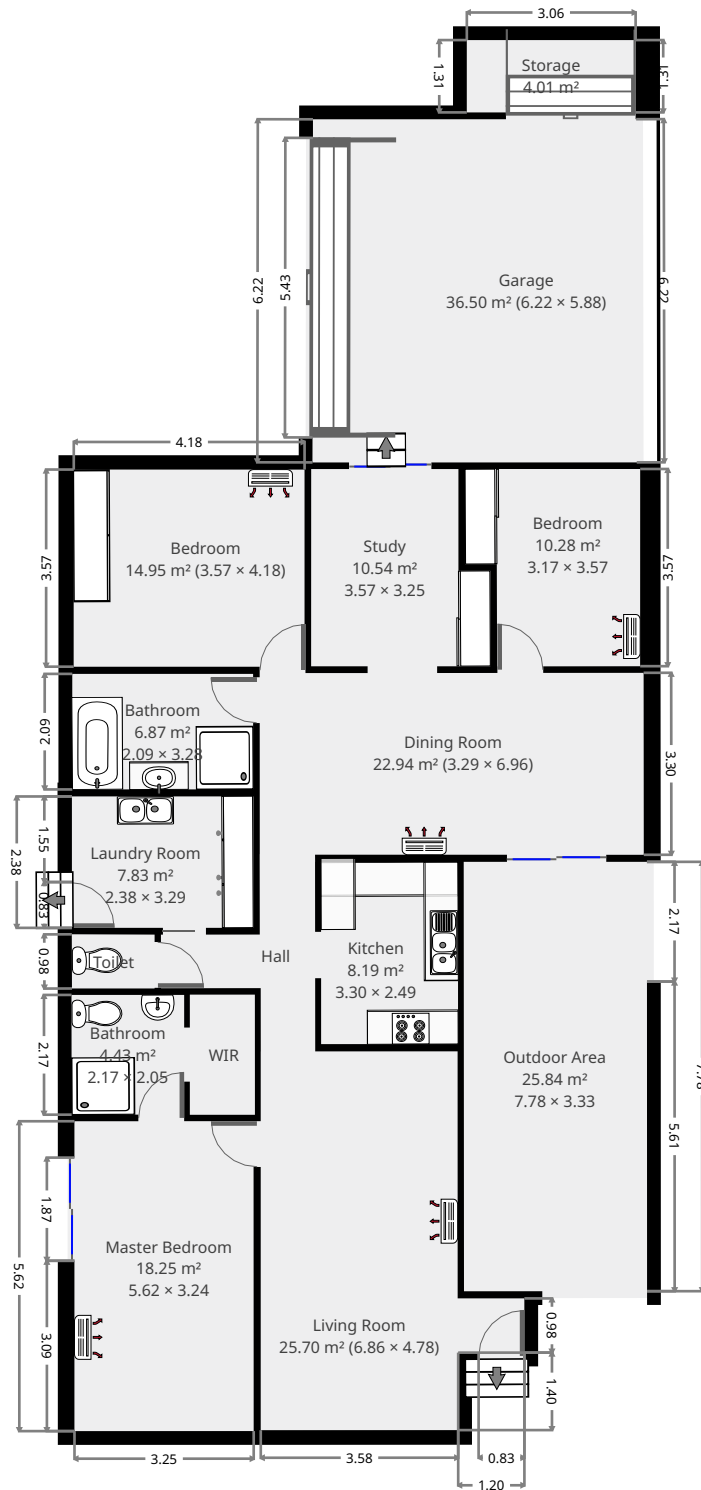

THIS FLOORPLAN IS PROVIDED WITHOUT WARRANTY OF ANY KIND. SENSOPIA DISCLAIMS ANY WARRANTY INCLUDING, WITHOUT LIMITATION, SATISFACTORY QUALITY OR ACCURACY OF DIMENSIONS.



327 Warnock Street

Living Room

Width: 4.78 m
 Length: 6.86 m
 Area: 25.70 m²
 Perimeter: 23.29 m

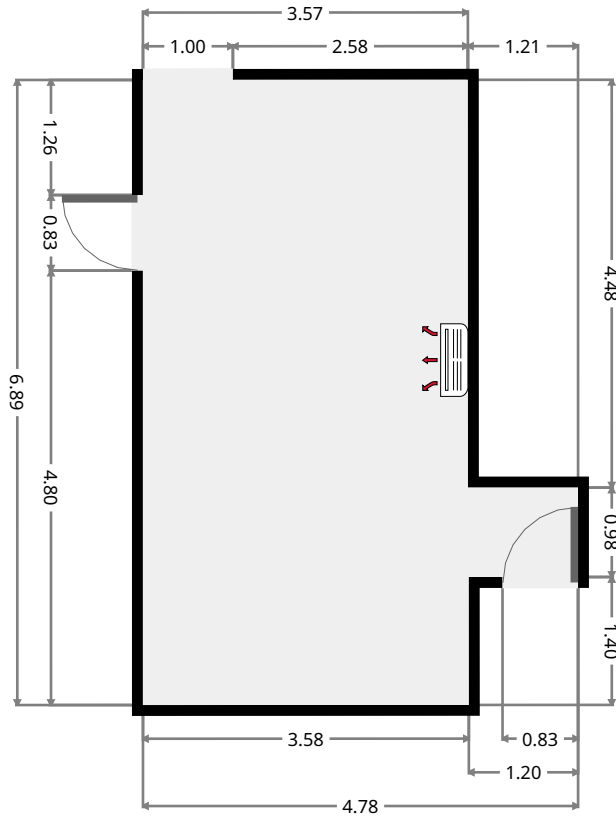
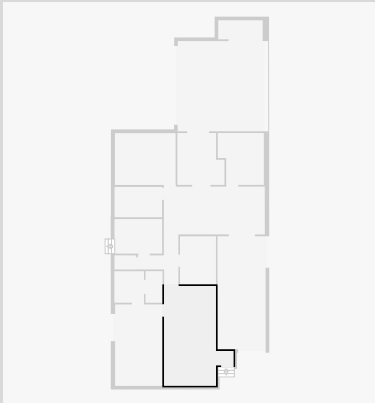

Master Bedroom

Width: 3.24 m
 Length: 5.62 m
 Area: 18.25 m²
 Perimeter: 17.73 m

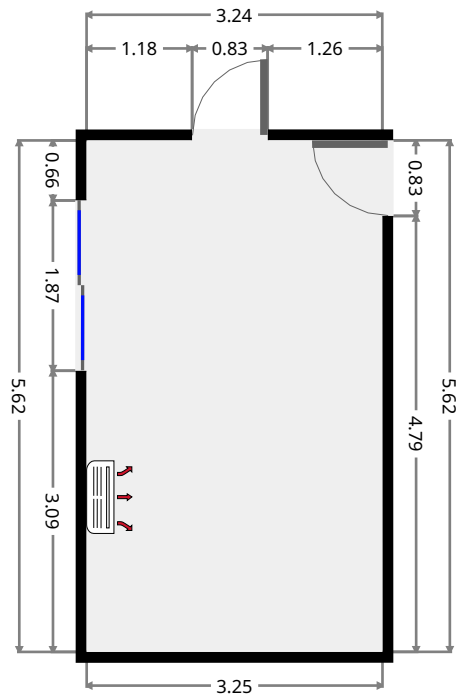
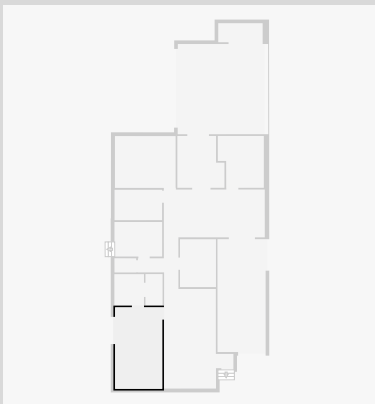

327 Warnock Street

Bathroom

Width: 2.05 m
 Length: 2.17 m
 Area: 4.43 m²
 Perimeter: 8.42 m

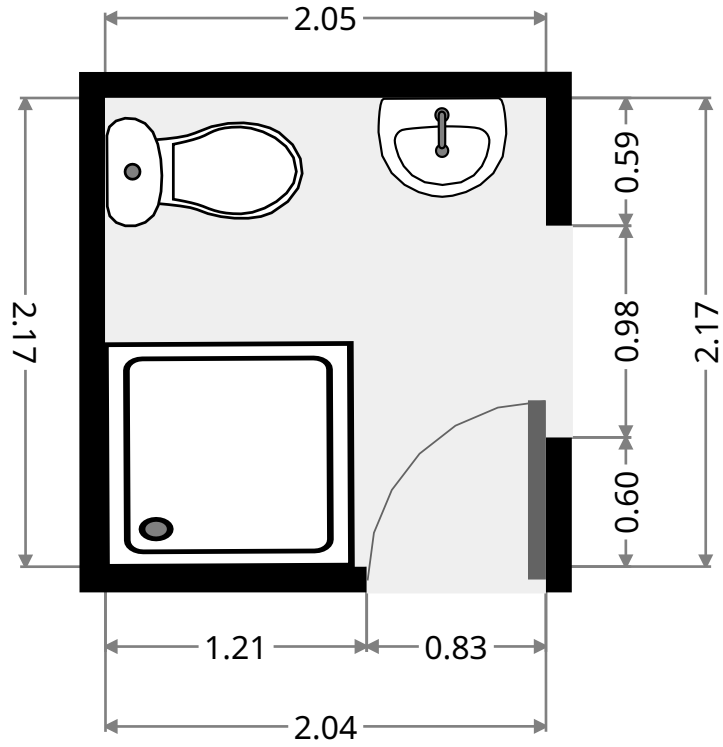
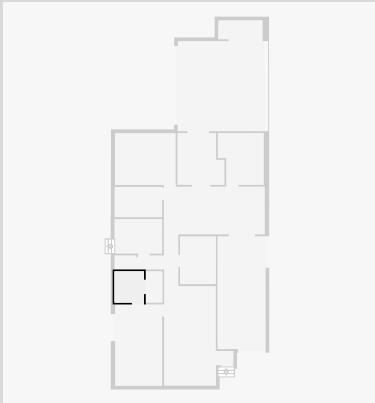

WIR

Width: 1.18 m
 Length: 2.18 m
 Area: 2.57 m²
 Perimeter: 6.72 m

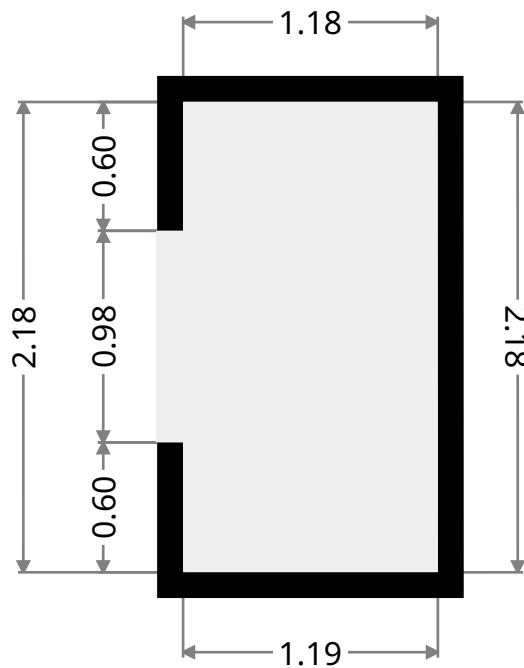
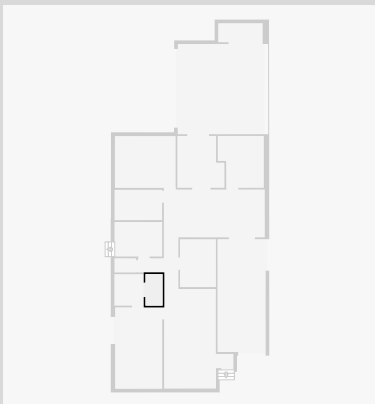

327 Warnock Street

Hall

Width: 2.80 m
 Length: 3.37 m
 Area: 5.09 m²
 Perimeter: 12.31 m

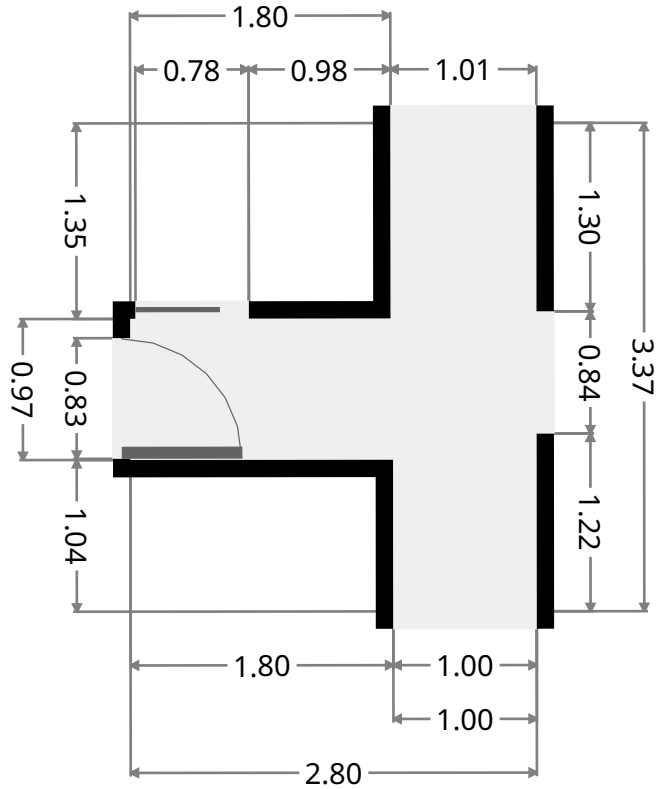
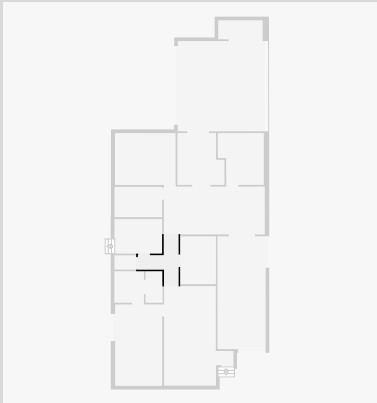

Laundry Room

Width: 2.38 m
 Length: 3.29 m
 Area: 7.83 m²
 Perimeter: 11.34 m

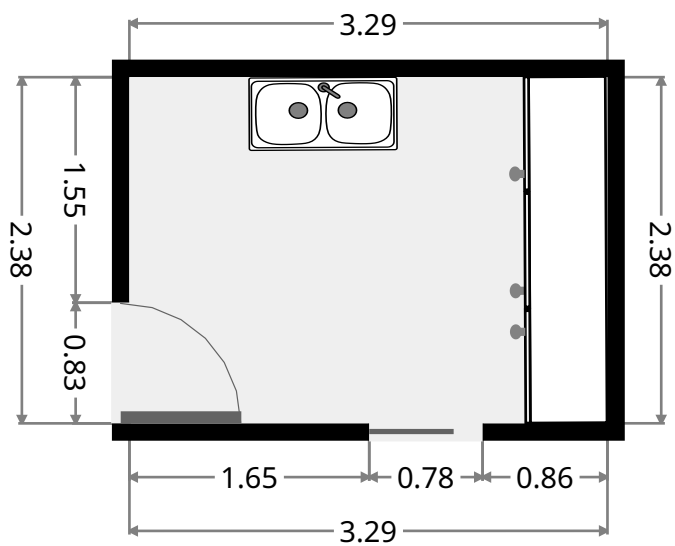
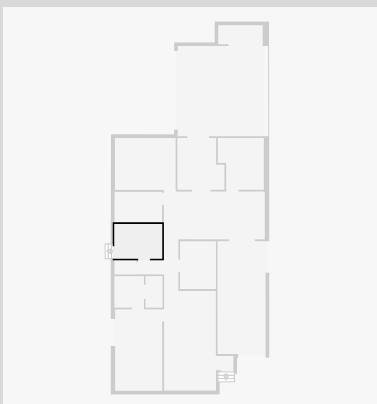

THIS FLOORPLAN IS PROVIDED WITHOUT WARRANTY OF ANY KIND. SENSOPIA DISCLAIMS ANY WARRANTY INCLUDING, WITHOUT LIMITATION, SATISFACTORY QUALITY OR ACCURACY OF DIMENSIONS.

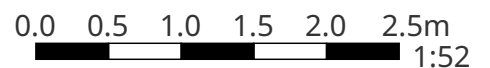

327 Warnock Street

Toilet

Width: 0.98 m
Length: 1.50 m
Area: 1.47 m²
Perimeter: 4.96 m

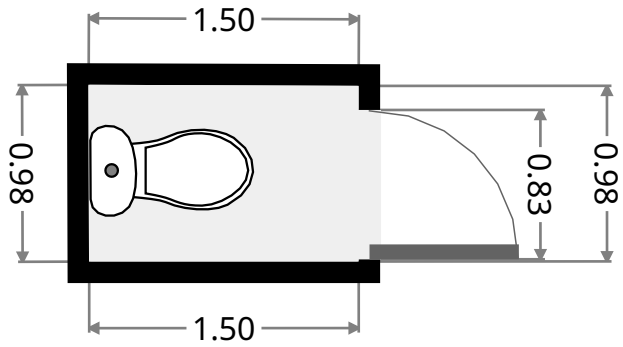
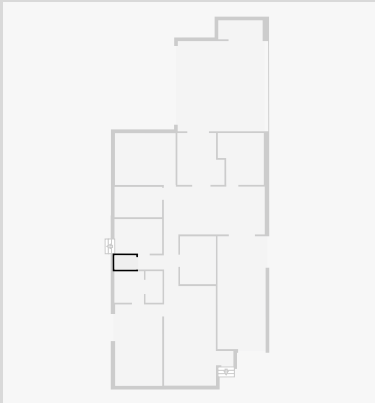

Kitchen

Width: 2.49 m
Length: 3.30 m
Area: 8.19 m²
Perimeter: 11.56 m

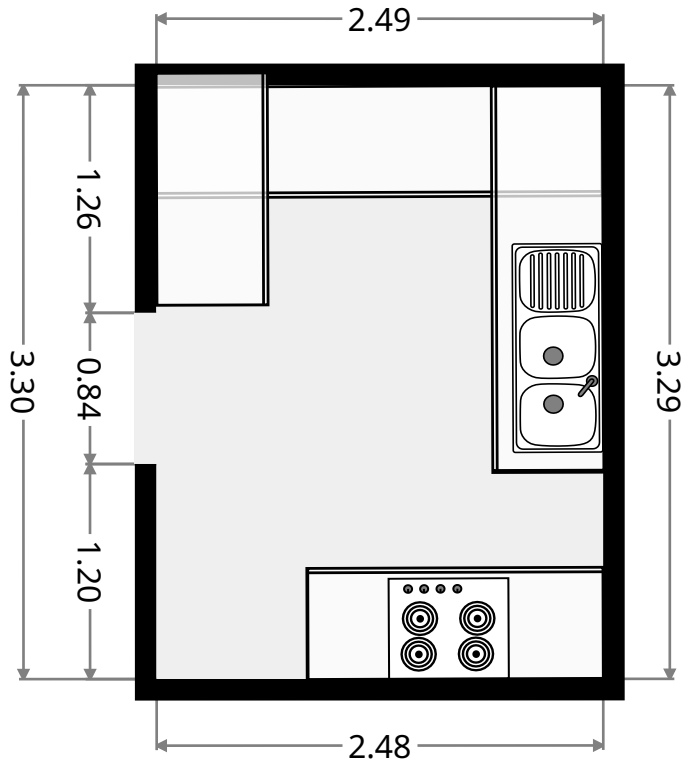
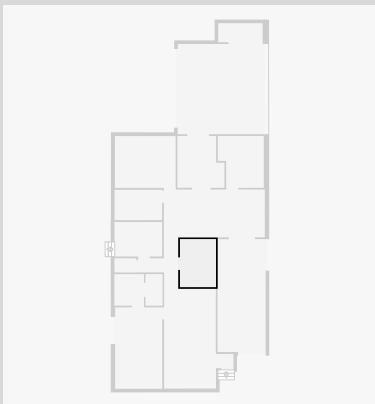

THIS FLOORPLAN IS PROVIDED WITHOUT WARRANTY OF ANY KIND. SENSOPIA DISCLAIMS ANY WARRANTY INCLUDING, WITHOUT LIMITATION, SATISFACTORY QUALITY OR ACCURACY OF DIMENSIONS.

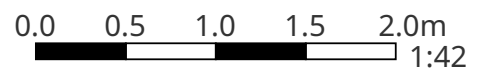

327 Warnock Street

Dining Room

Width: 3.29 m
Length: 6.96 m
Area: 22.94 m²
Perimeter: 20.51 m

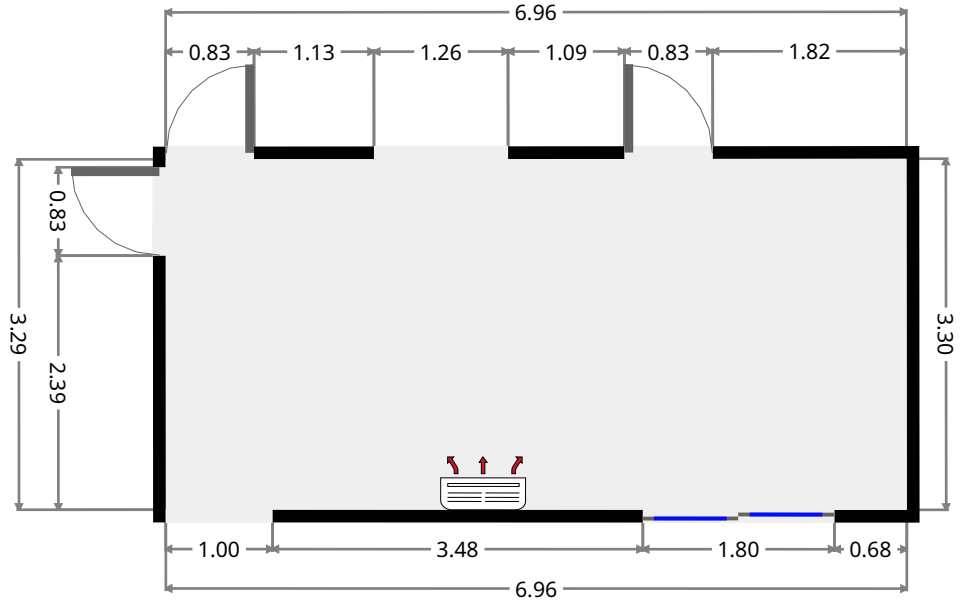
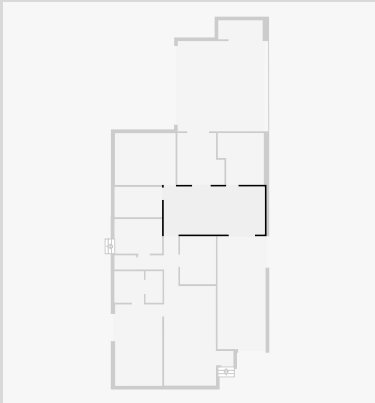

Bathroom

Width: 2.09 m
Length: 3.28 m
Area: 6.87 m²
Perimeter: 10.75 m

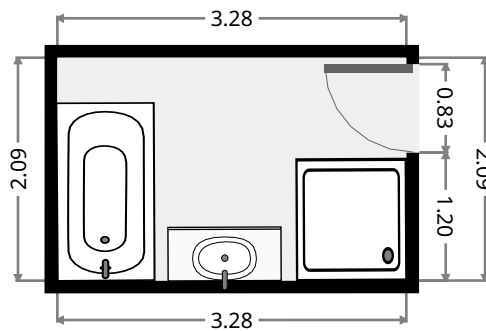
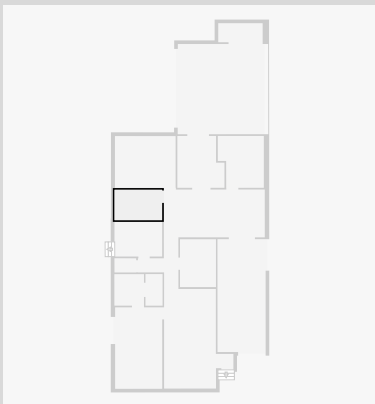

327 Warnock Street

Bedroom

Width: 3.57 m
 Length: 4.18 m
 Area: 14.95 m²
 Perimeter: 15.52 m

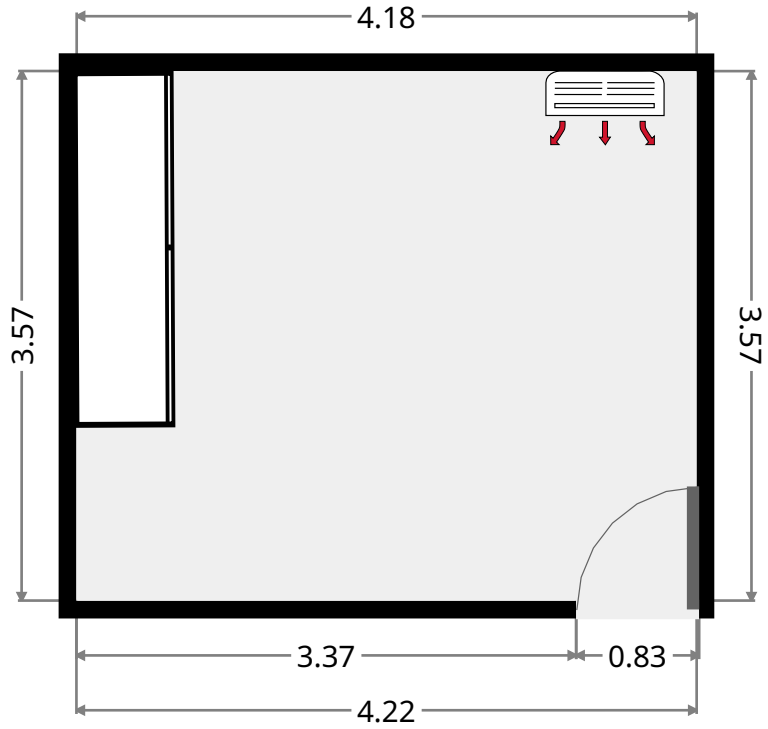
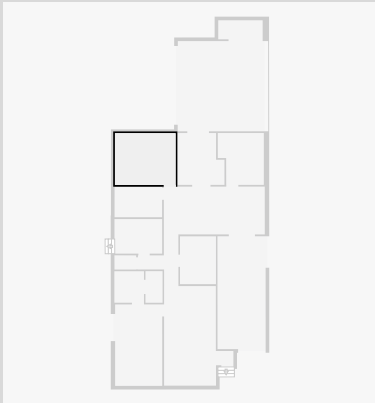

Study

Width: 3.25 m
 Length: 3.57 m
 Area: 10.54 m²
 Perimeter: 13.65 m

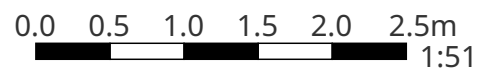
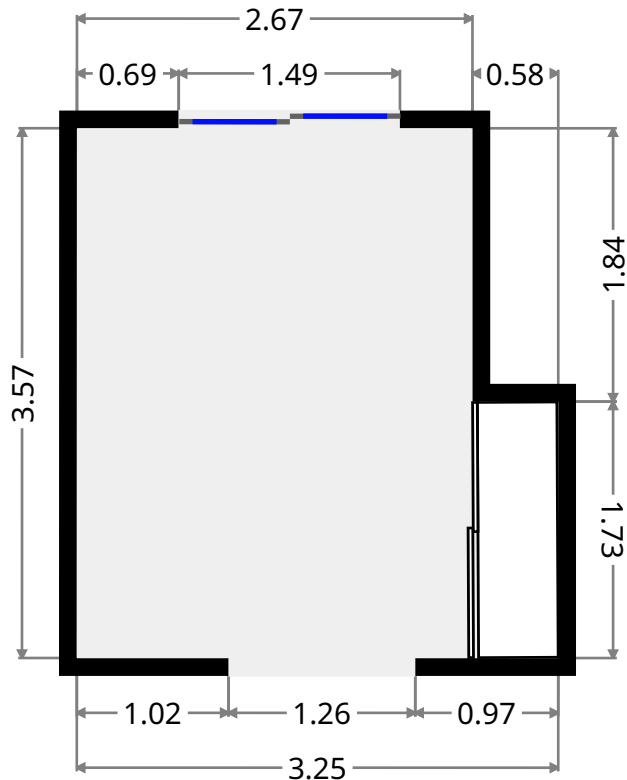
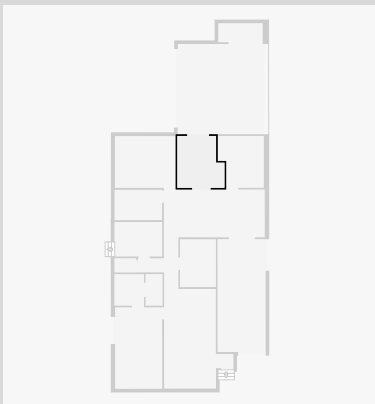

THIS FLOORPLAN IS PROVIDED WITHOUT WARRANTY OF ANY KIND. SENSOPIA DISCLAIMS ANY WARRANTY INCLUDING, WITHOUT LIMITATION, SATISFACTORY QUALITY OR ACCURACY OF DIMENSIONS.

327 Warnock Street

Bedroom

Width: 3.17 m
Length: 3.57 m
Area: 10.28 m²
Perimeter: 13.50 m

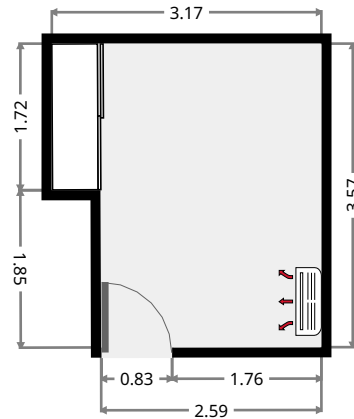
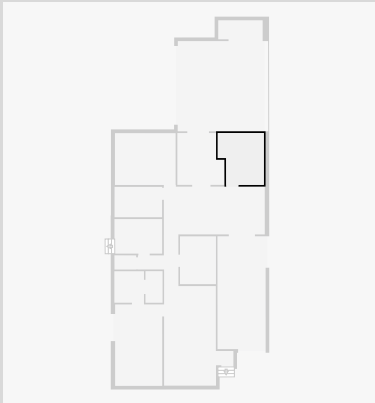

Garage

Width: 5.88 m
Length: 6.22 m
Area: 36.50 m²
Perimeter: 24.18 m

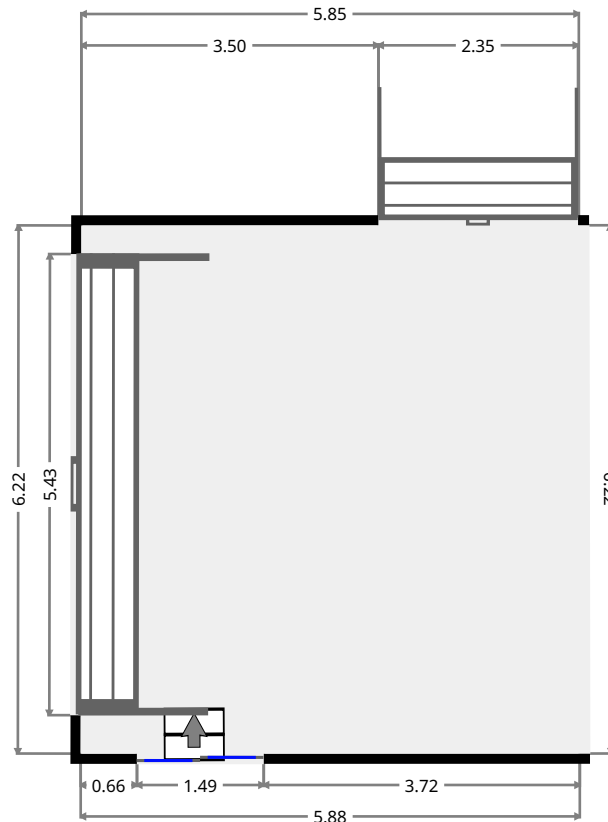
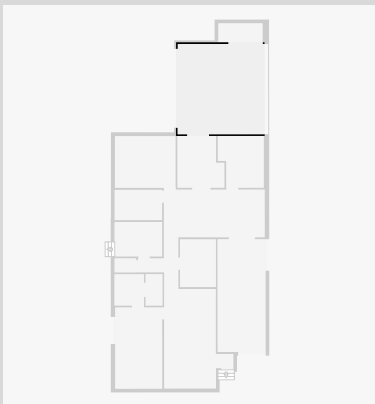

THIS FLOORPLAN IS PROVIDED WITHOUT WARRANTY OF ANY KIND. SENSOPIA DISCLAIMS ANY WARRANTY INCLUDING, WITHOUT LIMITATION, SATISFACTORY QUALITY OR ACCURACY OF DIMENSIONS.

327 Warnock Street

Storage

Width: 1.31 m
Length: 3.06 m
Area: 4.01 m²
Perimeter: 8.74 m

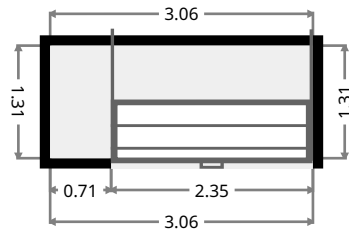
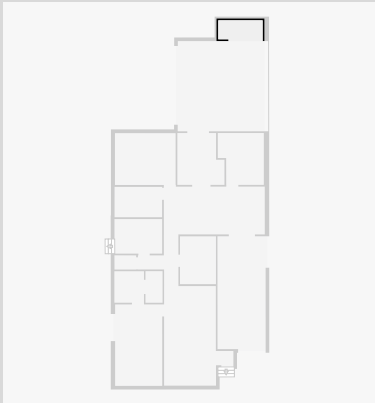

Outdoor Area

Width: 3.33 m
Length: 7.78 m
Area: 25.84 m²
Perimeter: 22.21 m

