

31 Glencoe Street

Ground Floor

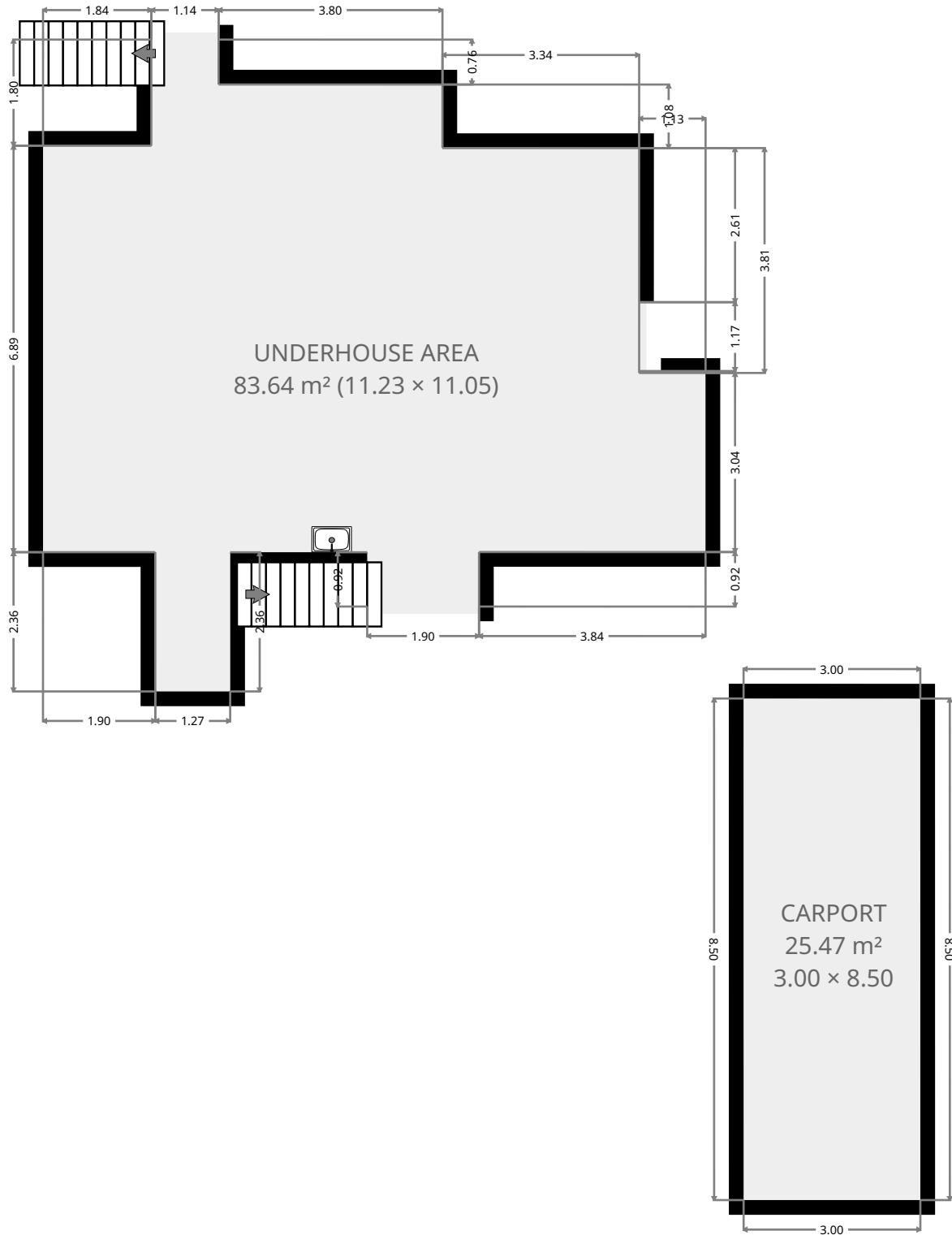

THIS FLOORPLAN IS PROVIDED WITHOUT WARRANTY OF ANY KIND. SENSOPIA DISCLAIMS ANY WARRANTY INCLUDING, WITHOUT LIMITATION, SATISFACTORY QUALITY OR ACCURACY OF DIMENSIONS.

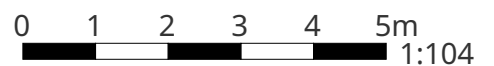

31 Glencoe Street

Underhouse Area

Width: 11.05 m
Length: 11.23 m
Area: 83.64 m²
Perimeter: 46.40 m

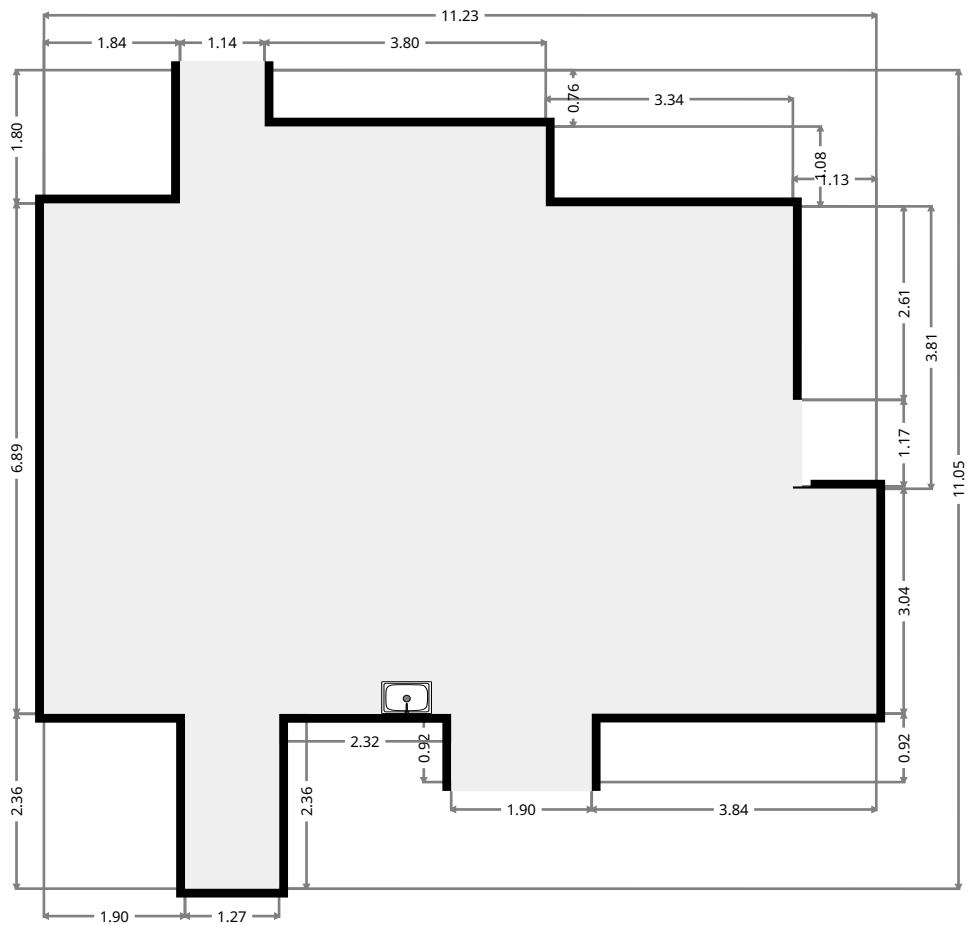
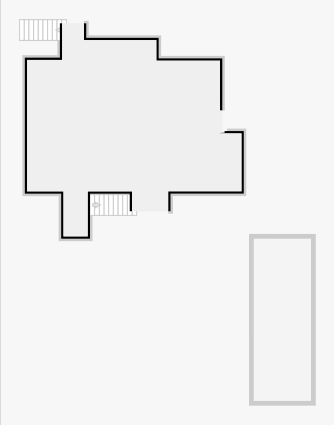

THIS FLOORPLAN IS PROVIDED WITHOUT WARRANTY OF ANY KIND. SENSOPIA DISCLAIMS ANY WARRANTY INCLUDING, WITHOUT LIMITATION, SATISFACTORY QUALITY OR ACCURACY OF DIMENSIONS.

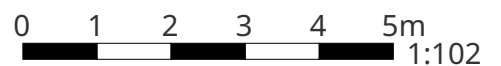

31 Glencoe Street

Carport

Width: 3.00 m
Length: 8.50 m
Area: 25.47 m²
Perimeter: 22.99 m

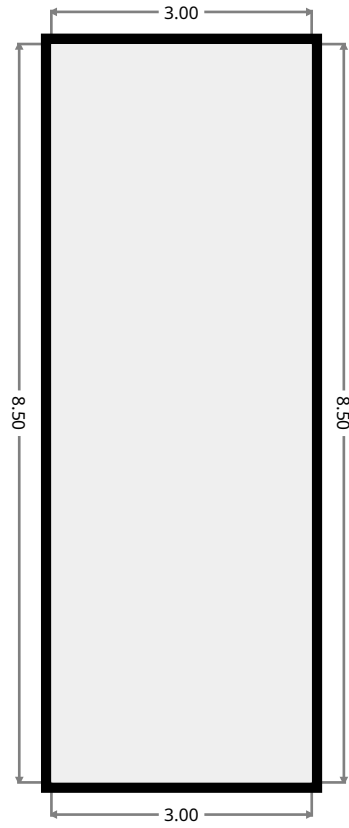
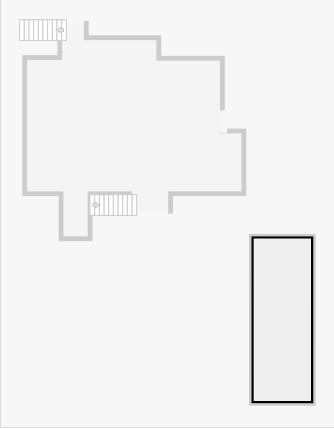

31 Glencoe Street

1st Floor



THIS FLOORPLAN IS PROVIDED WITHOUT WARRANTY OF ANY KIND. SENSOPIA DISCLAIMS ANY WARRANTY INCLUDING, WITHOUT LIMITATION, SATISFACTORY QUALITY OR ACCURACY OF DIMENSIONS.

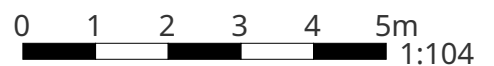

31 Glencoe Street

Living/Dining/Kitchen

Width: 6.89 m
 Length: 7.30 m
 Area: 39.92 m²
 Perimeter: 28.38 m

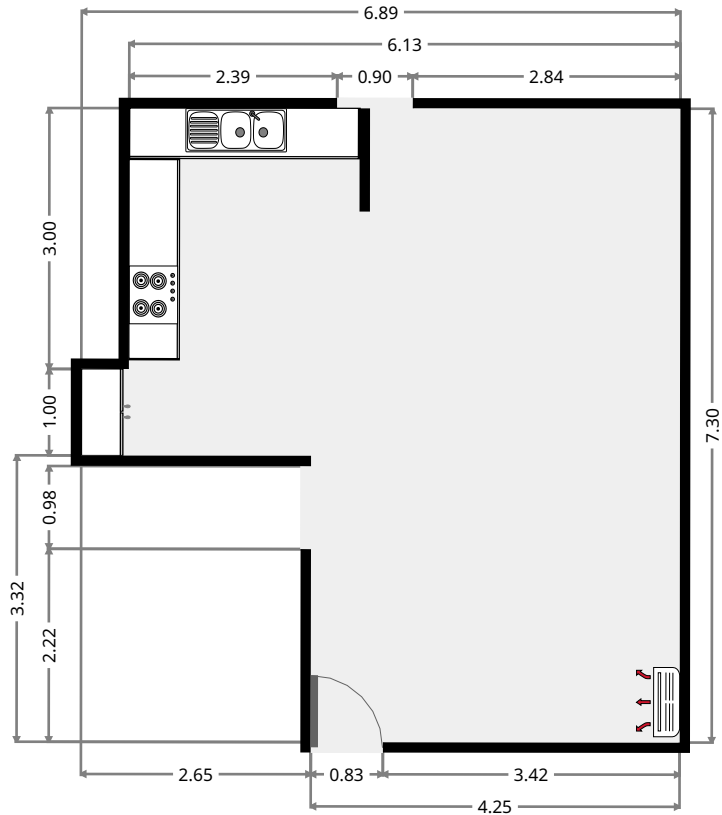
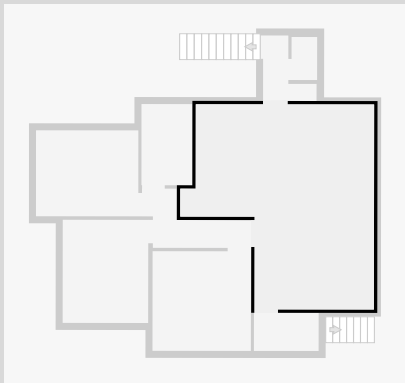

Hall

Width: 1.90 m
 Length: 2.34 m
 Area: 2.70 m²
 Perimeter: 8.46 m

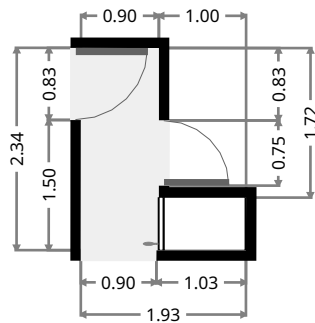
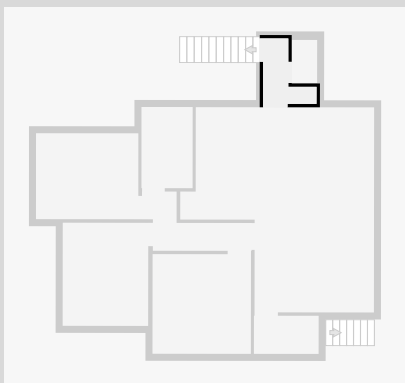

31 Glencoe Street

Toilet

Width: 0.91 m
 Length: 1.52 m
 Area: 1.39 m²
 Perimeter: 4.88 m

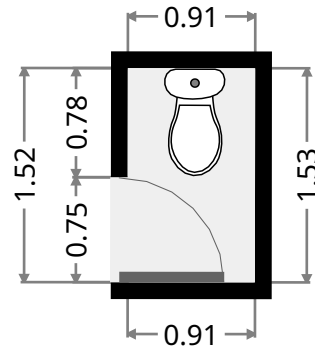
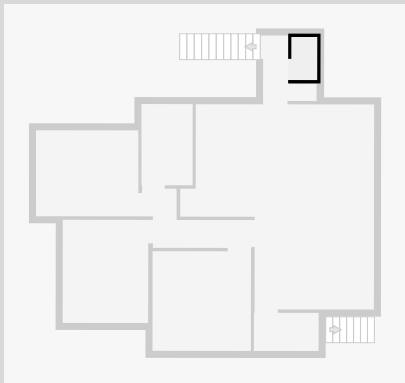

Hall

Width: 2.11 m
 Length: 3.90 m
 Area: 4.80 m²
 Perimeter: 12.01 m

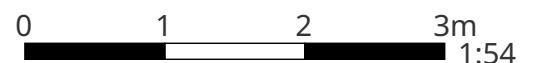
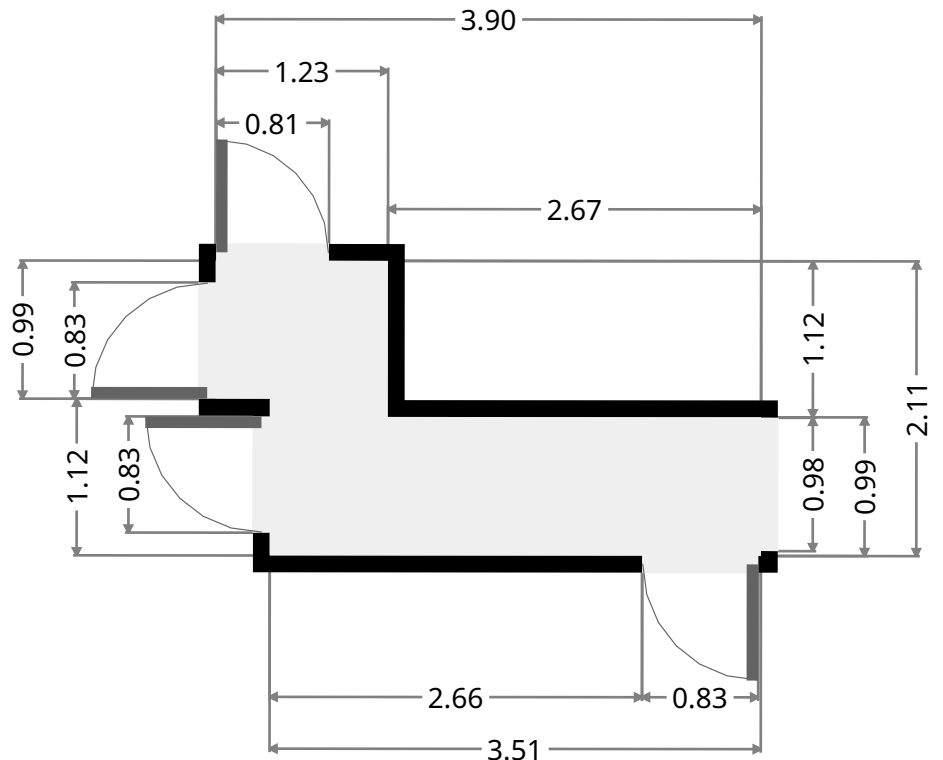
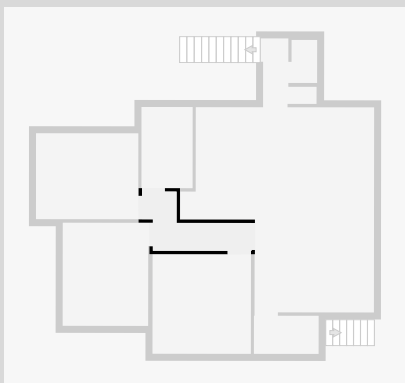

THIS FLOORPLAN IS PROVIDED WITHOUT WARRANTY OF ANY KIND. SENSOPIA DISCLAIMS ANY WARRANTY INCLUDING, WITHOUT LIMITATION, SATISFACTORY QUALITY OR ACCURACY OF DIMENSIONS.

31 Glencoe Street

Bedroom

Width: 3.04 m
 Length: 3.67 m
 Area: 11.16 m²
 Perimeter: 13.42 m

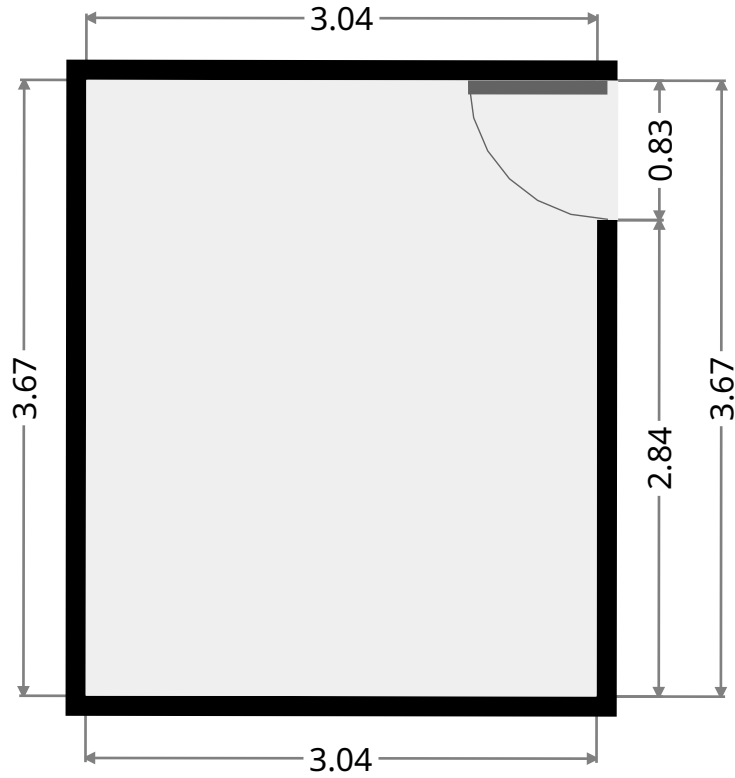
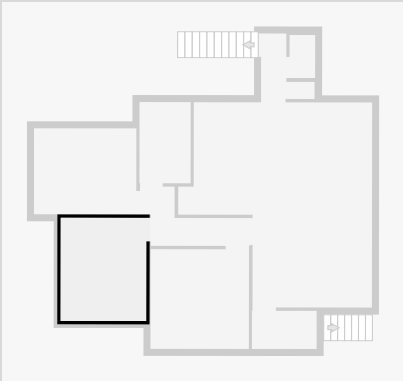

Bedroom

Width: 3.06 m
 Length: 3.64 m
 Area: 11.13 m²
 Perimeter: 13.40 m

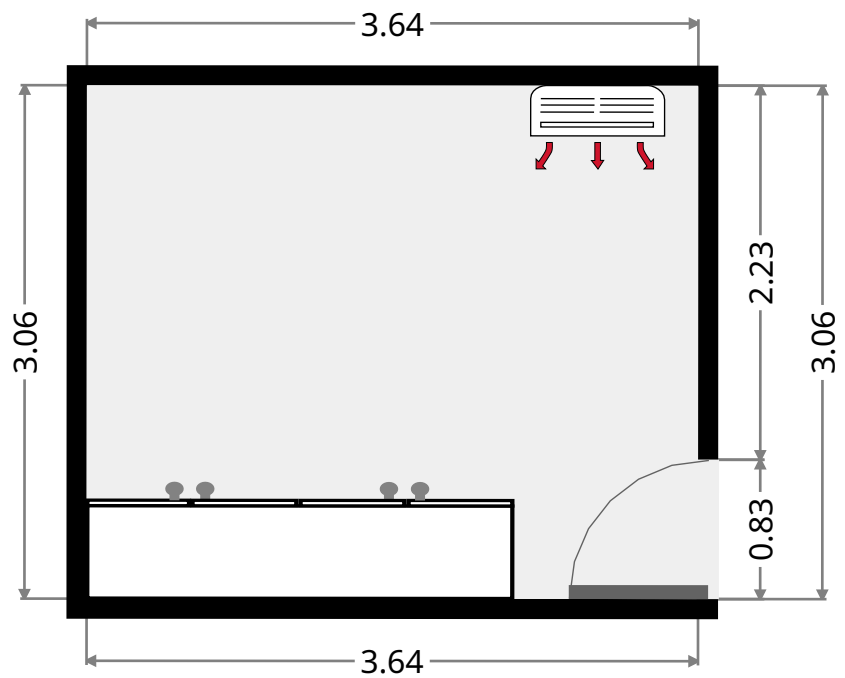
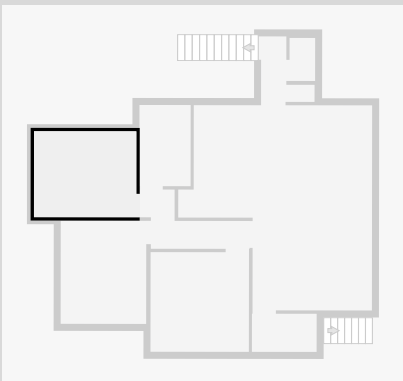

THIS FLOORPLAN IS PROVIDED WITHOUT WARRANTY OF ANY KIND. SENSOPIA DISCLAIMS ANY WARRANTY INCLUDING, WITHOUT LIMITATION, SATISFACTORY QUALITY OR ACCURACY OF DIMENSIONS.

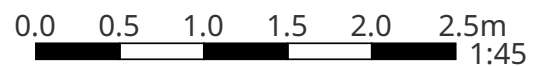

31 Glencoe Street

Bathroom

Width: 1.82 m
Length: 2.89 m
Area: 5.25 m²
Perimeter: 9.41 m

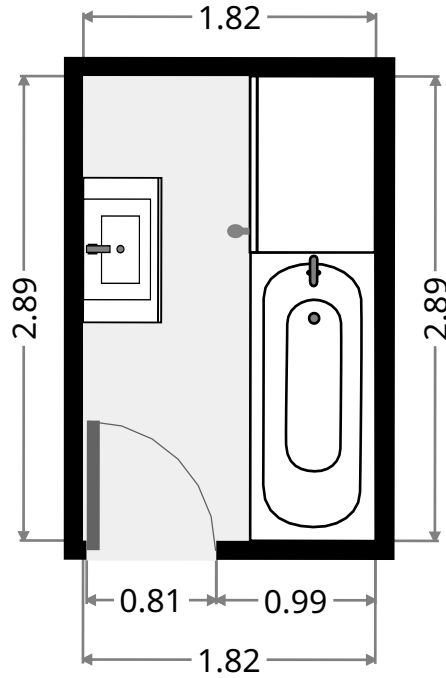
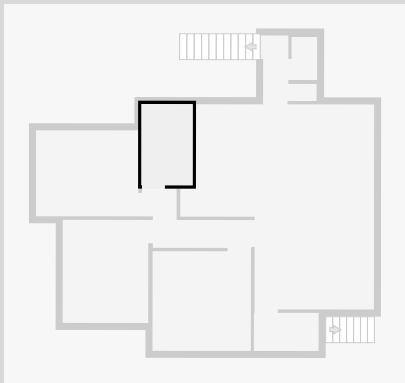

Master Bedroom

Width: 3.50 m
Length: 3.54 m
Area: 12.40 m²
Perimeter: 14.08 m

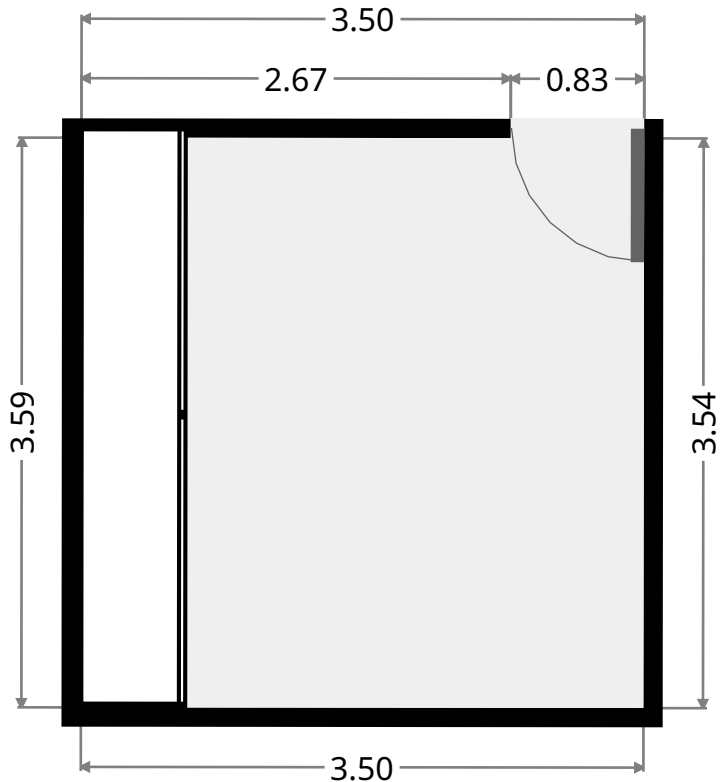
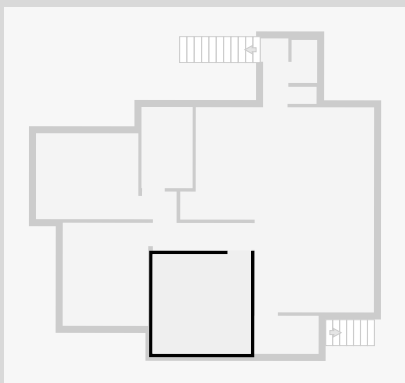

THIS FLOORPLAN IS PROVIDED WITHOUT WARRANTY OF ANY KIND. SENSOPIA DISCLAIMS ANY WARRANTY INCLUDING, WITHOUT LIMITATION, SATISFACTORY QUALITY OR ACCURACY OF DIMENSIONS.

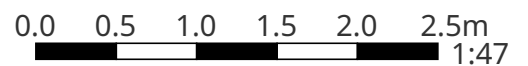

31 Glencoe Street

Verandah

Width: 1.36 m
Length: 2.30 m
Area: 3.12 m²
Perimeter: 7.32 m

