

31 Belbowrie Avenue

Ground Floor



THIS FLOORPLAN IS PROVIDED WITHOUT WARRANTY OF ANY KIND. SENSOPIA DISCLAIMS ANY WARRANTY INCLUDING, WITHOUT LIMITATION, SATISFACTORY QUALITY OR ACCURACY OF DIMENSIONS.



31 Belbowrie Avenue

Media Room

Width: 3.98 m
 Length: 4.03 m
 Area: 16.02 m²
 Perimeter: 16.01 m

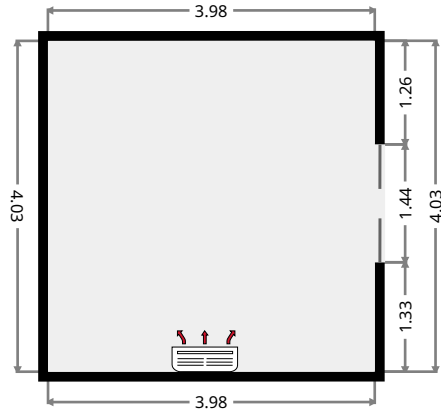
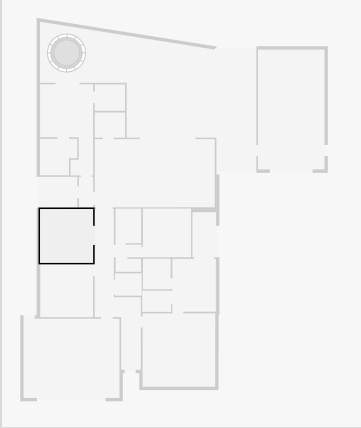

Awning

Width: 3.00 m
 Length: 9.00 m
 Area: 26.99 m²
 Perimeter: 24.00 m

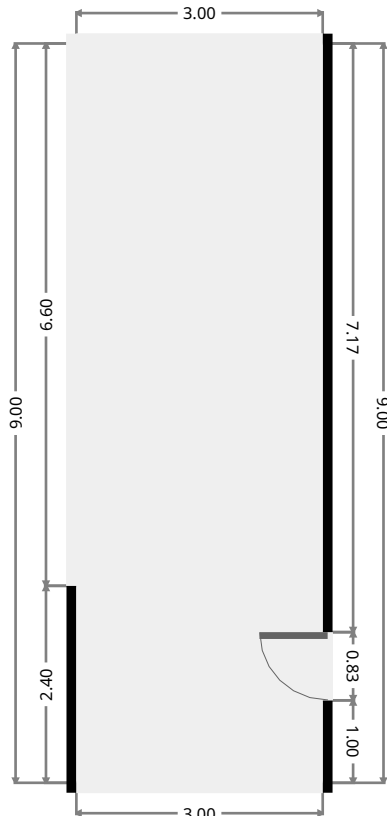

THIS FLOORPLAN IS PROVIDED WITHOUT WARRANTY OF ANY KIND. SENSOPIA DISCLAIMS ANY WARRANTY INCLUDING, WITHOUT LIMITATION, SATISFACTORY QUALITY OR ACCURACY OF DIMENSIONS.

31 Belbowrie Avenue

Garage

Width: 5.00 m
 Length: 9.00 m
 Area: 45.00 m²
 Perimeter: 28.00 m

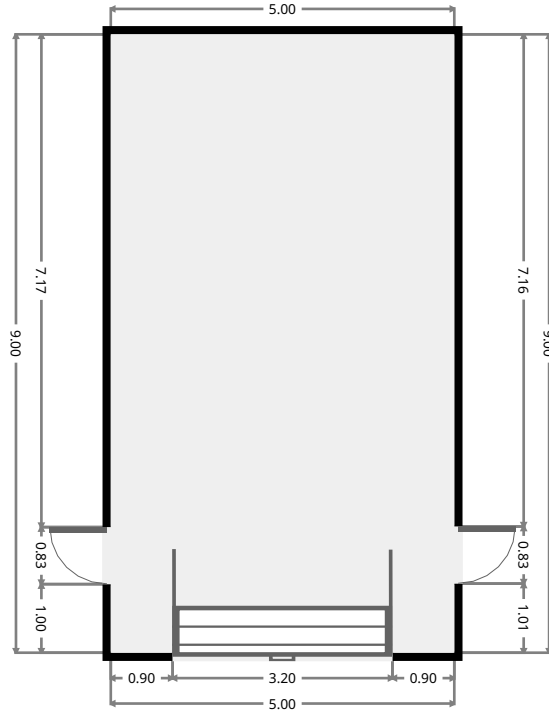
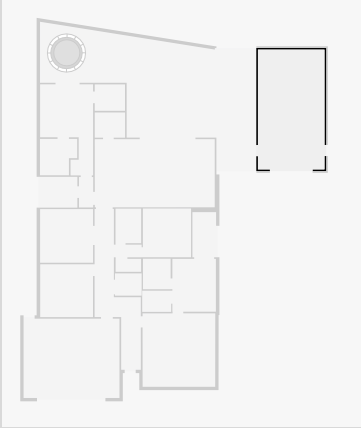

Outdoor Area

Width: 0.00 m
 Length: 13.30 m
 Area: 73.73 m²
 Perimeter: 41.74 m

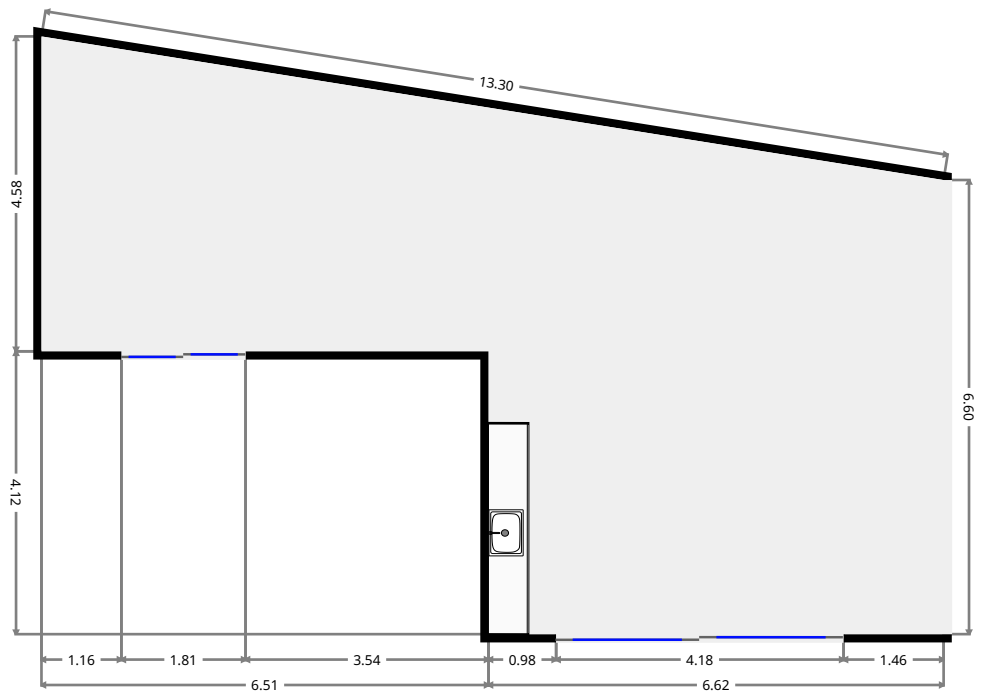

THIS FLOORPLAN IS PROVIDED WITHOUT WARRANTY OF ANY KIND. SENSOPIA DISCLAIMS ANY WARRANTY INCLUDING, WITHOUT LIMITATION, SATISFACTORY QUALITY OR ACCURACY OF DIMENSIONS.

31 Belbowrie Avenue

Laundry Room

Width: 1.78 m
Length: 3.39 m
Area: 6.03 m²
Perimeter: 10.33 m

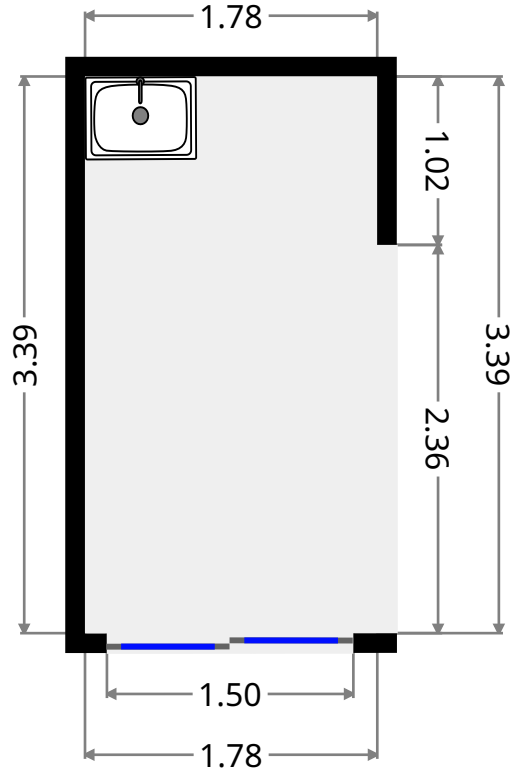

WIR

Width: 1.98 m
Length: 2.27 m
Area: 4.50 m²
Perimeter: 8.51 m

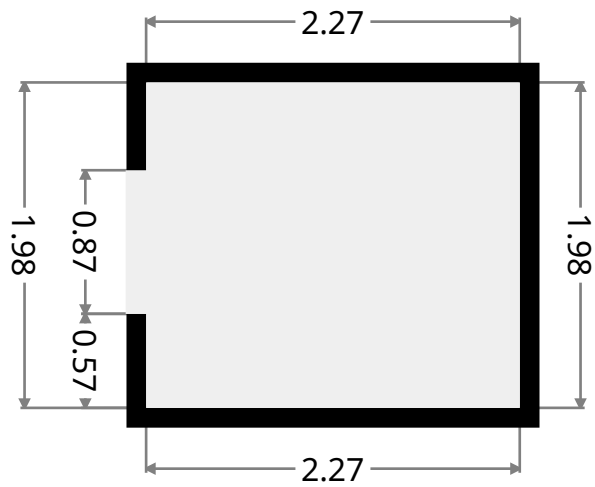

31 Belbowrie Avenue

Laundry Room

Width: 2.32 m
 Length: 2.81 m
 Area: 6.50 m²
 Perimeter: 10.24 m

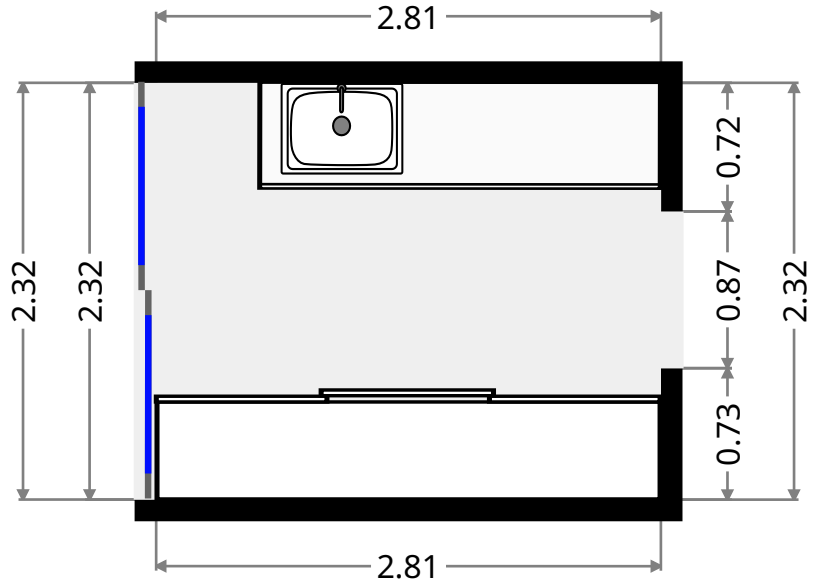

Hall

Width: 1.07 m
 Length: 2.28 m
 Area: 2.45 m²
 Perimeter: 6.71 m

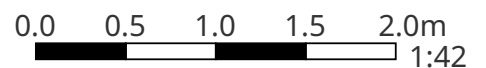
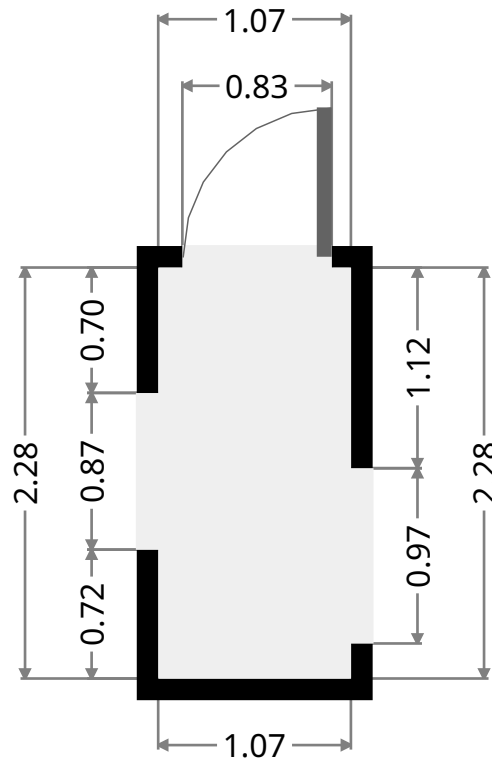
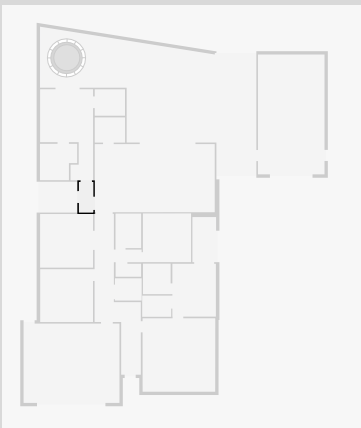

THIS FLOORPLAN IS PROVIDED WITHOUT WARRANTY OF ANY KIND. SENSOPIA DISCLAIMS ANY WARRANTY INCLUDING, WITHOUT LIMITATION, SATISFACTORY QUALITY OR ACCURACY OF DIMENSIONS.

31 Belbowrie Avenue

Pantry

Width: 1.89 m
 Length: 2.28 m
 Area: 4.31 m²
 Perimeter: 8.34 m

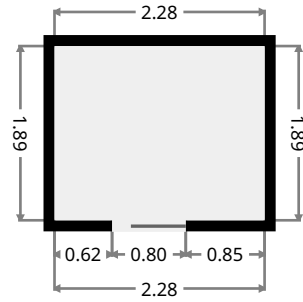

Kitchen/Living/Dining

Width: 5.12 m
 Length: 9.01 m
 Area: 46.10 m²
 Perimeter: 28.25 m

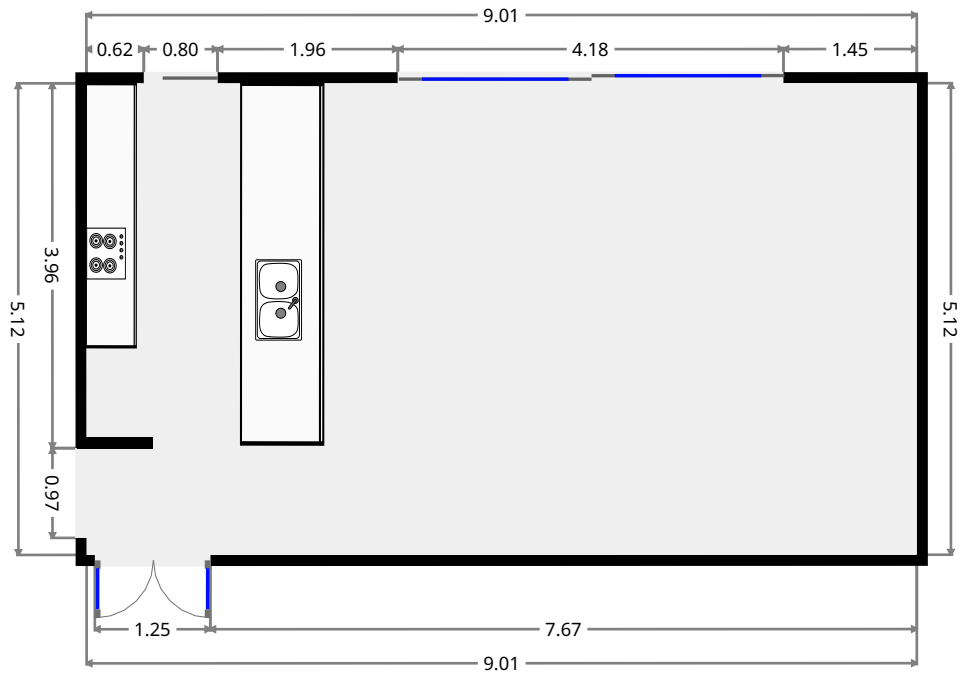
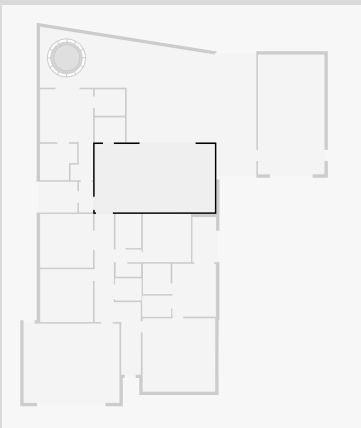

THIS FLOORPLAN IS PROVIDED WITHOUT WARRANTY OF ANY KIND. SENSOPIA DISCLAIMS ANY WARRANTY INCLUDING, WITHOUT LIMITATION, SATISFACTORY QUALITY OR ACCURACY OF DIMENSIONS.

31 Belbowrie Avenue

Hall

Width: 3.47 m
 Length: 12.08 m
 Area: 20.62 m²
 Perimeter: 31.11 m

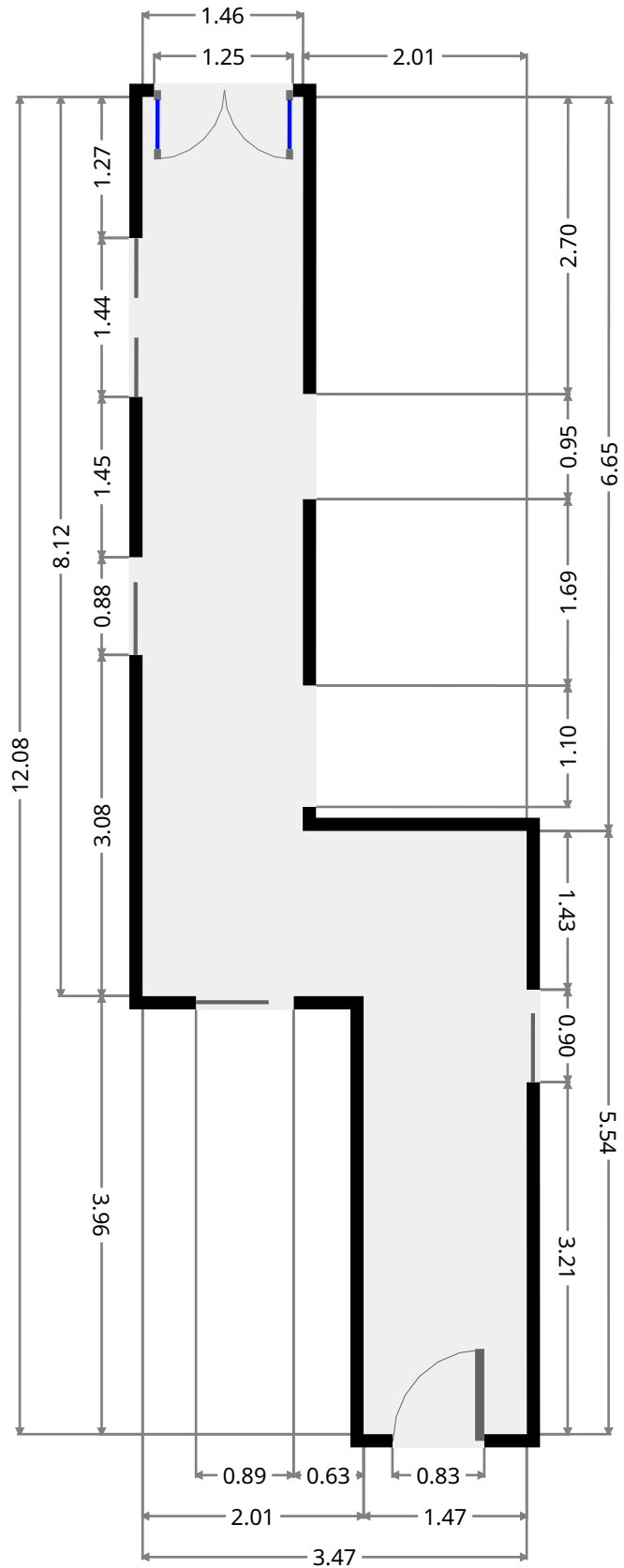

THIS FLOORPLAN IS PROVIDED WITHOUT WARRANTY OF ANY KIND. SENSOPIA DISCLAIMS ANY WARRANTY INCLUDING, WITHOUT LIMITATION, SATISFACTORY QUALITY OR ACCURACY OF DIMENSIONS.

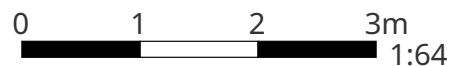

31 Belbowrie Avenue

Bathroom

Width: 1.93 m
Length: 2.60 m
Area: 5.01 m²
Perimeter: 9.05 m

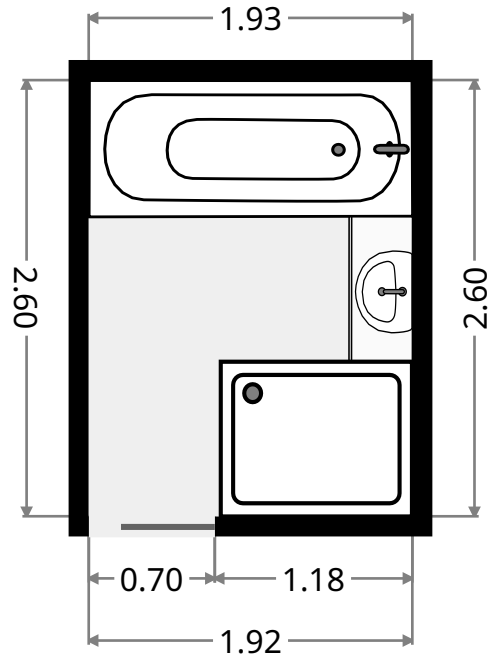

Bedroom

Width: 3.62 m
Length: 3.67 m
Area: 13.25 m²
Perimeter: 14.56 m

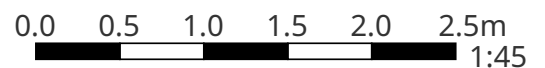
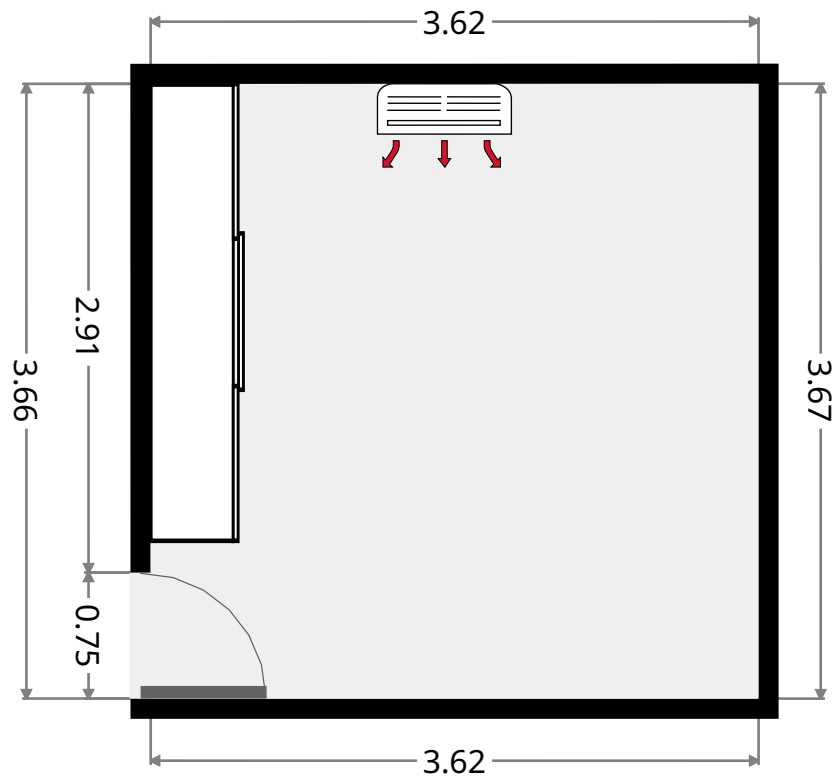
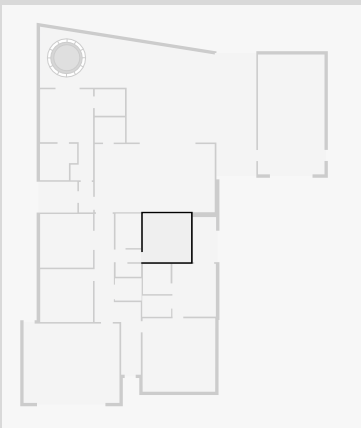

31 Belbowrie Avenue

Toilet

Width: 0.98 m
 Length: 1.92 m
 Area: 1.87 m²
 Perimeter: 5.78 m

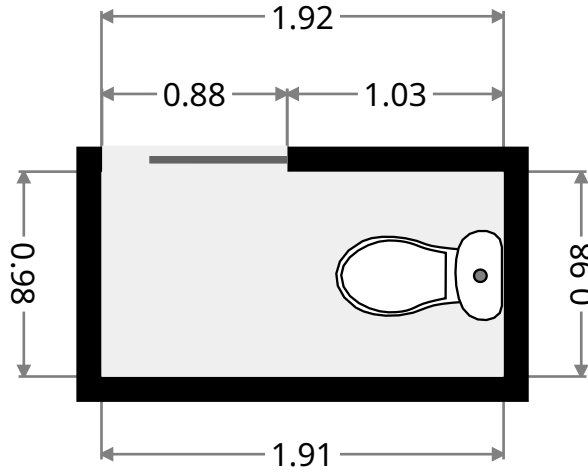

Hall

Width: 0.95 m
 Length: 2.00 m
 Area: 1.90 m²
 Perimeter: 5.90 m

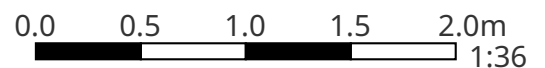
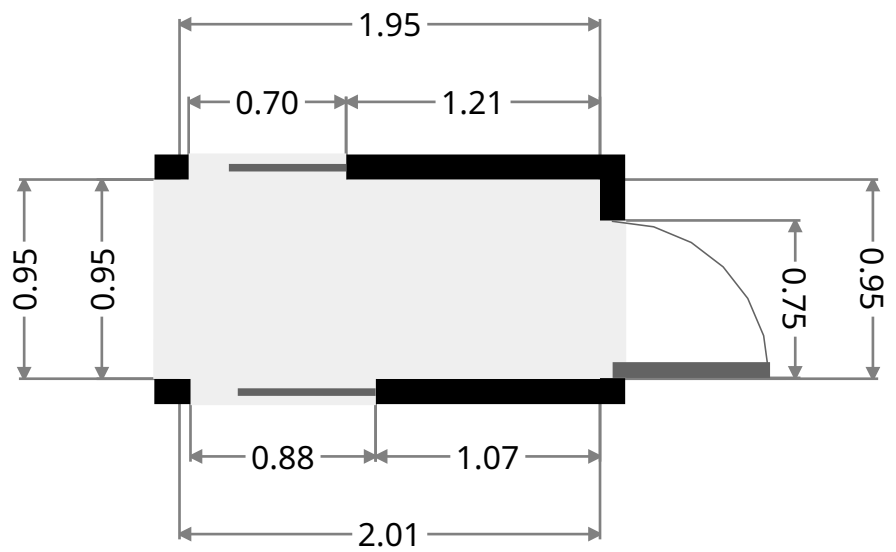

31 Belbowrie Avenue

Bedroom

Width: 3.97 m
Length: 3.97 m
Area: 15.74 m²
Perimeter: 15.87 m

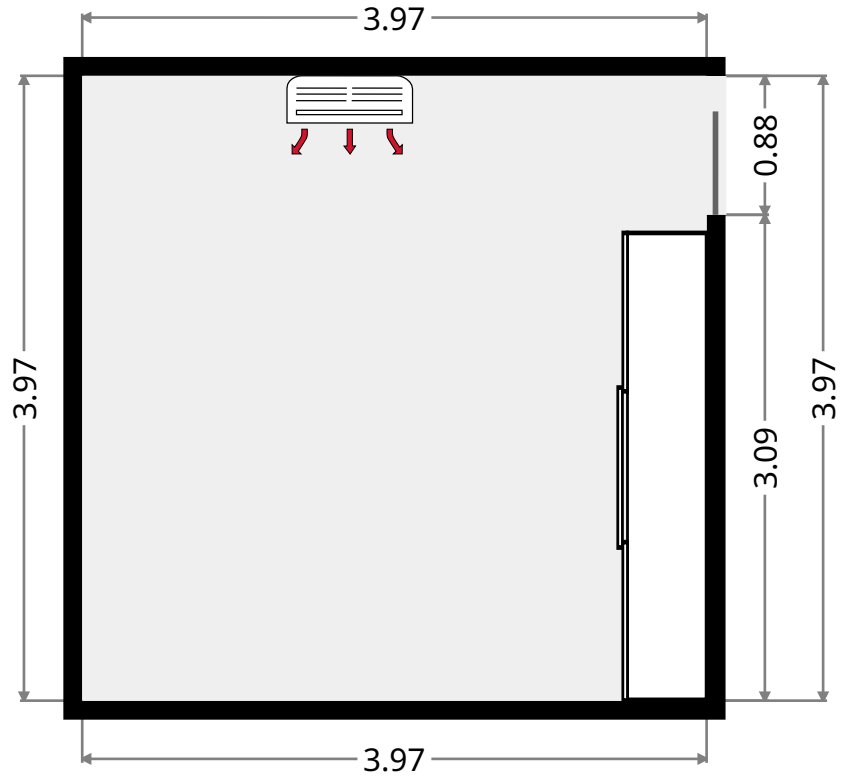

Study

Width: 1.67 m
Length: 2.01 m
Area: 3.35 m²
Perimeter: 7.35 m

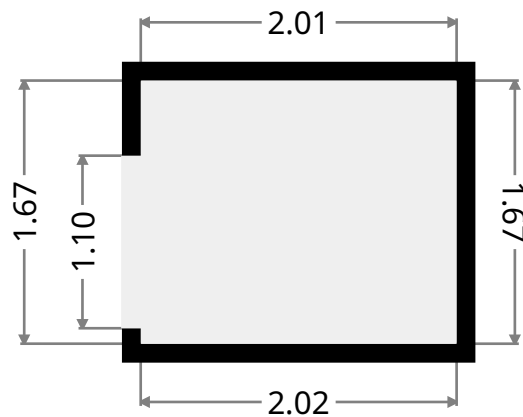

31 Belbowrie Avenue

Garage

Width: 5.96 m
 Length: 7.20 m
 Area: 42.92 m²
 Perimeter: 26.32 m

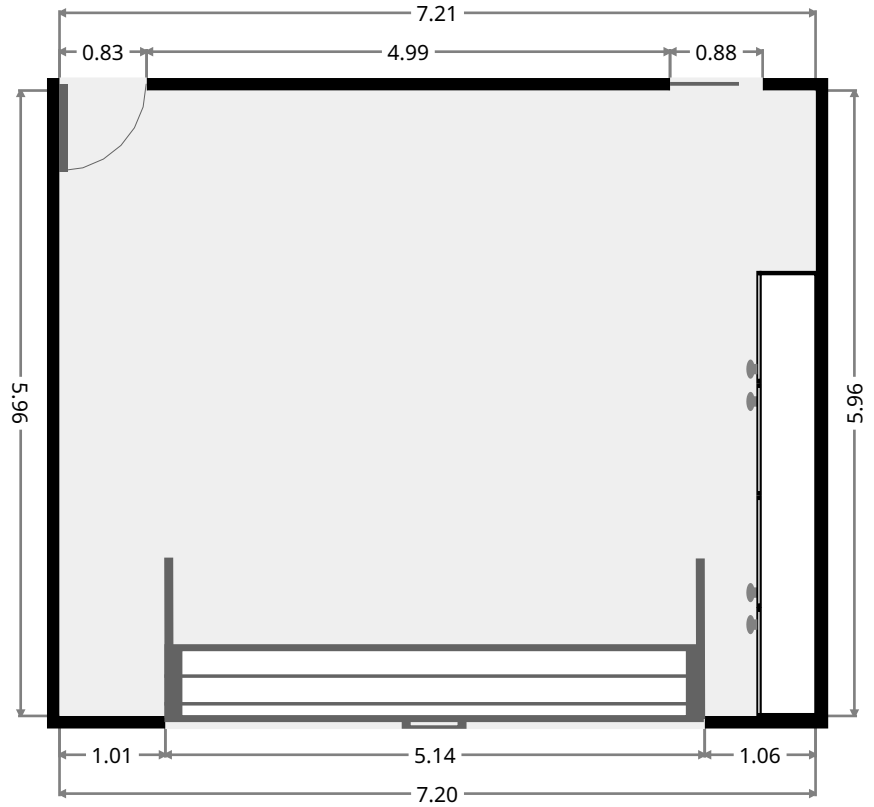
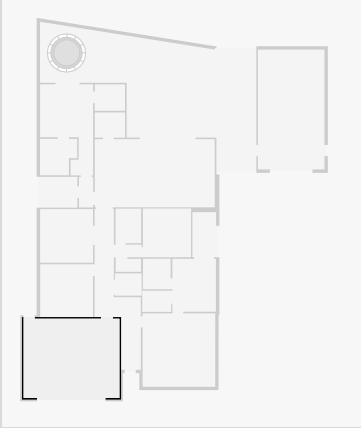

•
 Width: 1.59 m
 Length: 2.17 m
 Area: 3.46 m²
 Perimeter: 7.53 m

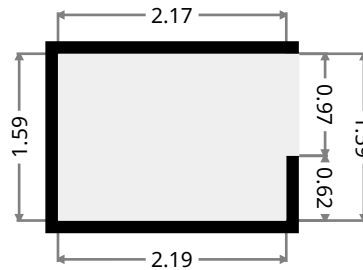

THIS FLOORPLAN IS PROVIDED WITHOUT WARRANTY OF ANY KIND. SENSOPIA DISCLAIMS ANY WARRANTY INCLUDING, WITHOUT LIMITATION, SATISFACTORY QUALITY OR ACCURACY OF DIMENSIONS.

31 Belbowrie Avenue

Bathroom

Width: 2.08 m
 Length: 2.30 m
 Area: 4.76 m²
 Perimeter: 8.74 m

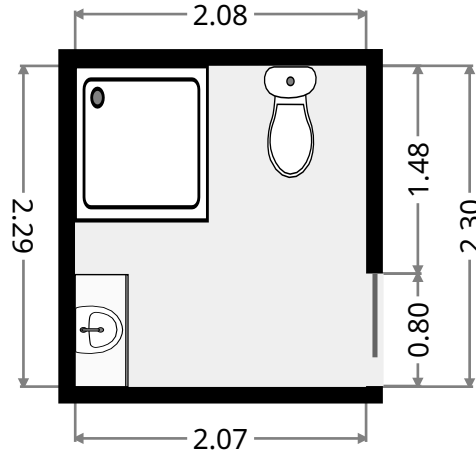

Bedroom

Width: 3.27 m
 Length: 3.97 m
 Area: 12.96 m²
 Perimeter: 14.47 m

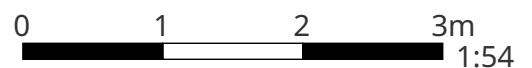
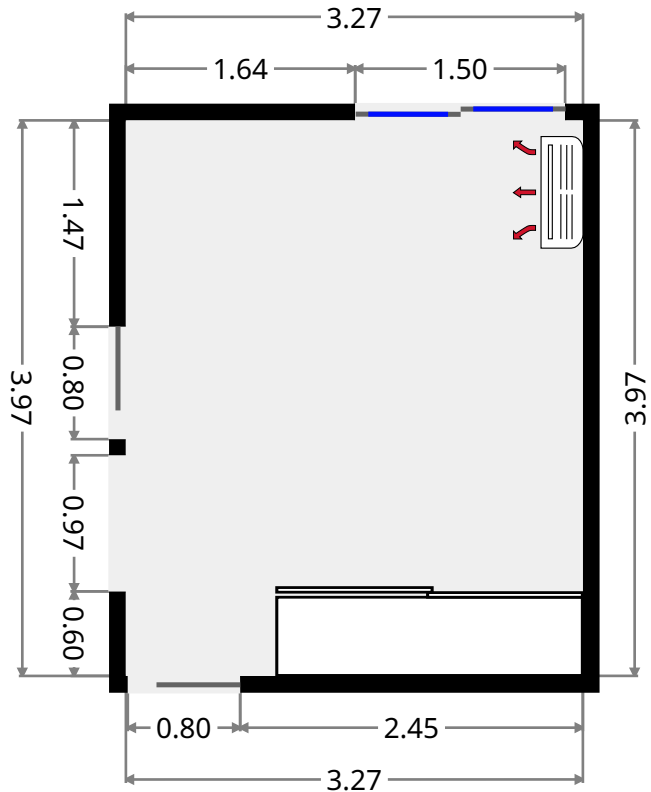
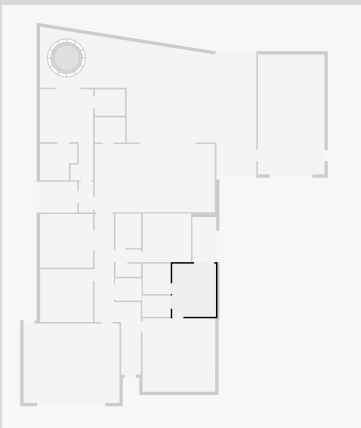

THIS FLOORPLAN IS PROVIDED WITHOUT WARRANTY OF ANY KIND. SENSOPIA DISCLAIMS ANY WARRANTY INCLUDING, WITHOUT LIMITATION, SATISFACTORY QUALITY OR ACCURACY OF DIMENSIONS.

31 Belbowrie Avenue

Rumpus Room

Width: 5.46 m
Length: 5.51 m
Area: 30.09 m²
Perimeter: 21.94 m

