

30 Rosewood Drive

Ground Floor

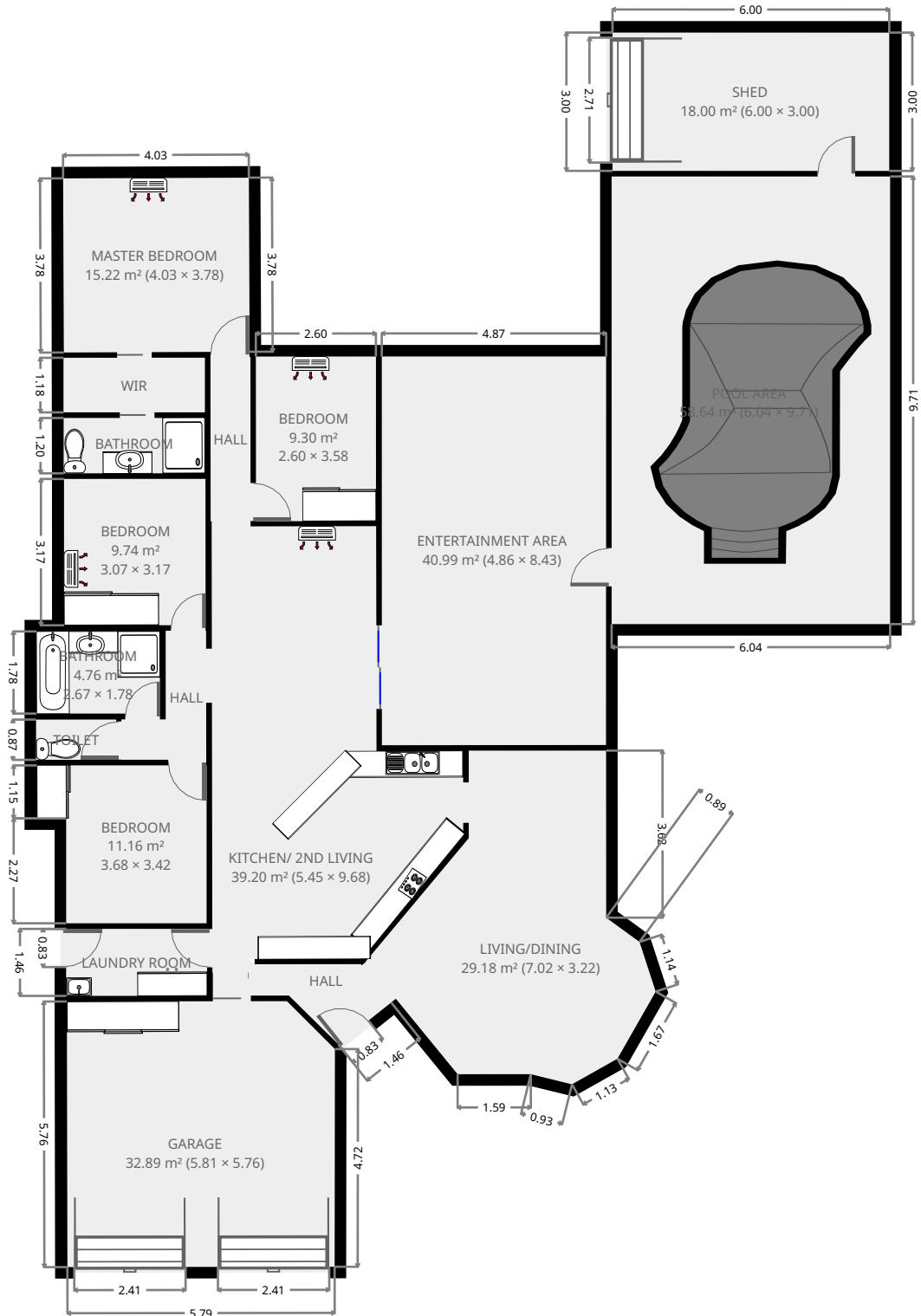

THIS FLOORPLAN IS PROVIDED WITHOUT WARRANTY OF ANY KIND. SENSOPIA DISCLAIMS ANY WARRANTY INCLUDING, WITHOUT LIMITATION, SATISFACTORY QUALITY OR ACCURACY OF DIMENSIONS.



30 Rosewood Drive

Bedroom

Width: 3.42 m
Length: 3.68 m
Area: 11.16 m²
Perimeter: 14.21 m

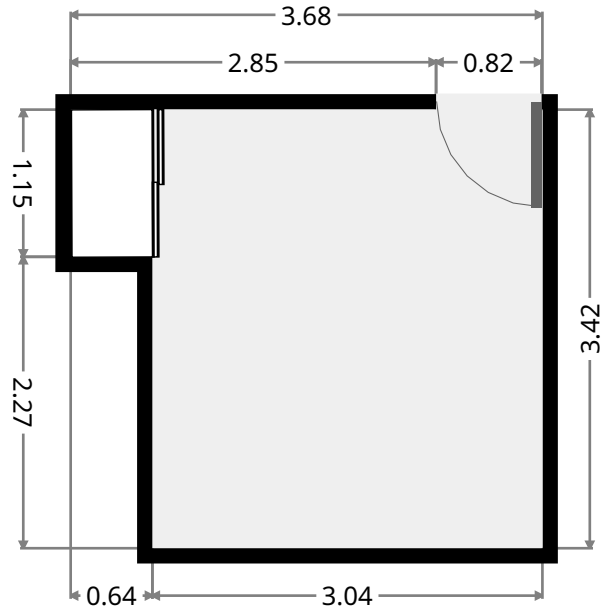
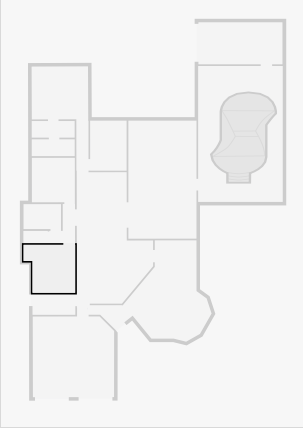

Shed

Width: 3.00 m
Length: 6.00 m
Area: 18.00 m²
Perimeter: 18.00 m

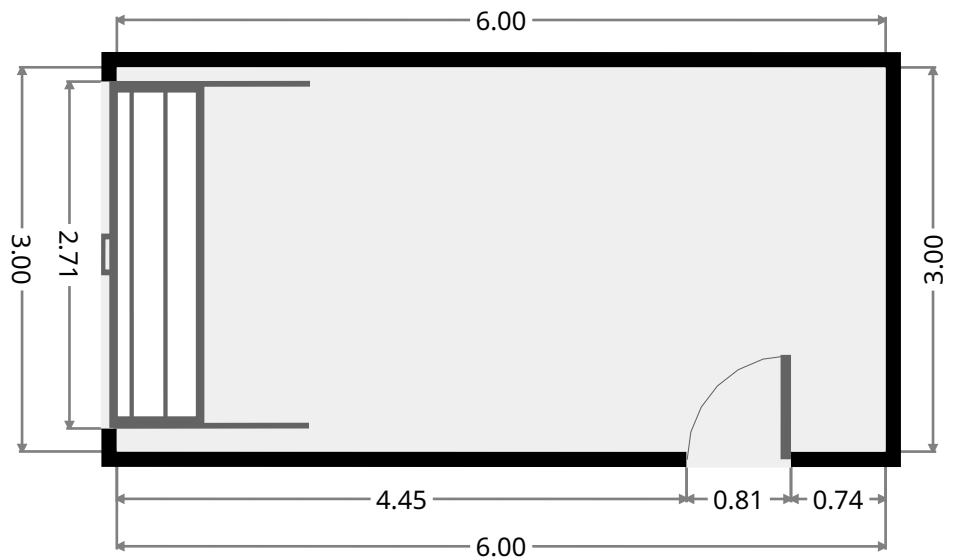
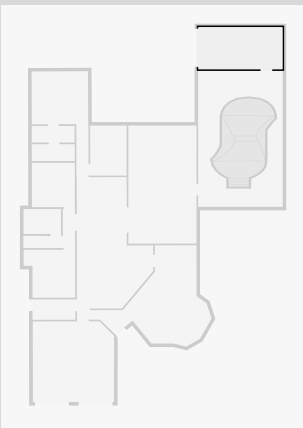

30 Rosewood Drive

Pool Area

Width: 6.04 m
 Length: 9.71 m
 Area: 58.64 m²
 Perimeter: 31.50 m

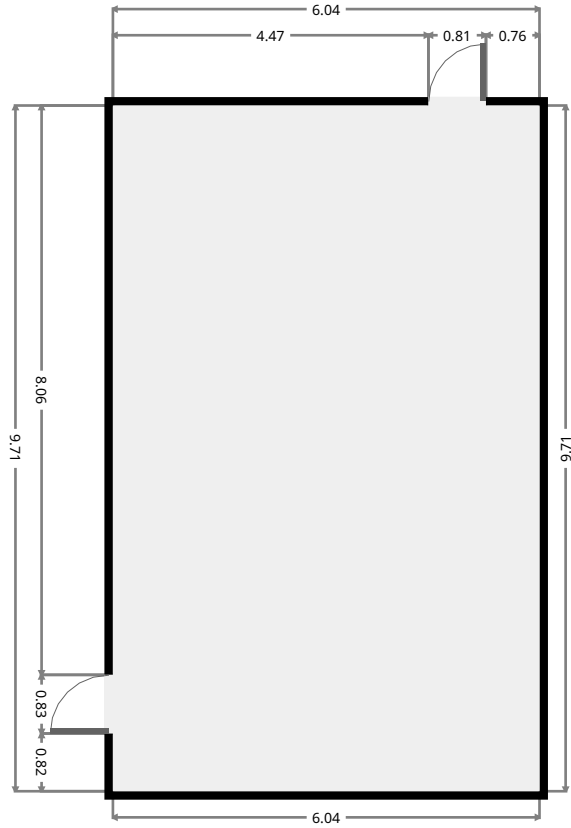
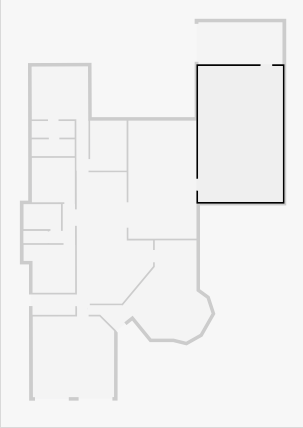

Entertainment Area

Width: 4.86 m
 Length: 8.43 m
 Area: 40.99 m²
 Perimeter: 26.58 m

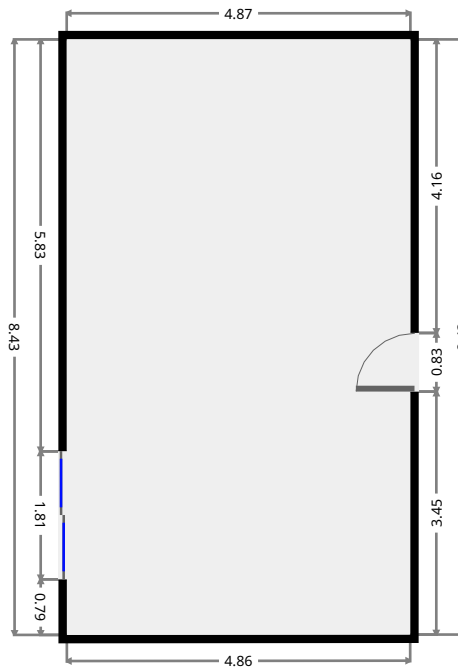
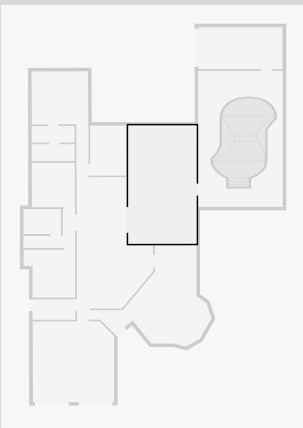

30 Rosewood Drive

Bathroom

Width: 1.20 m
Length: 3.07 m
Area: 3.68 m²
Perimeter: 8.53 m

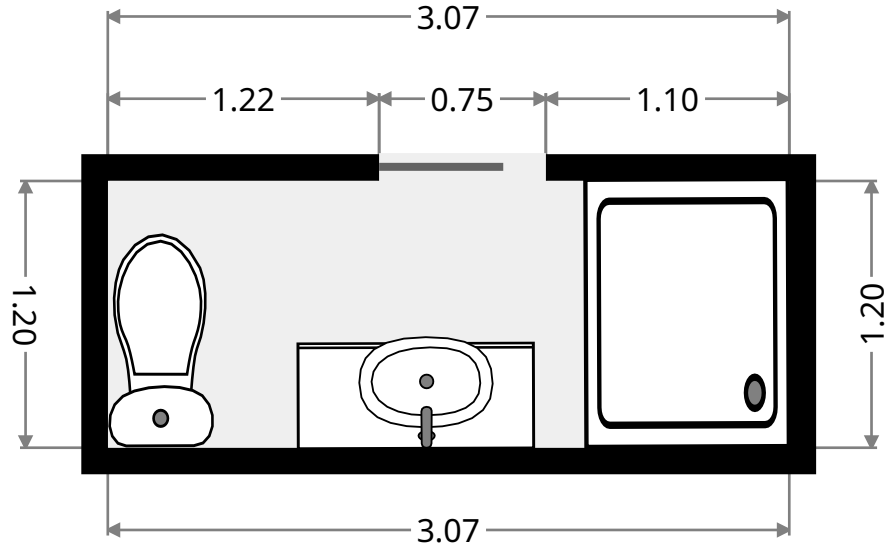
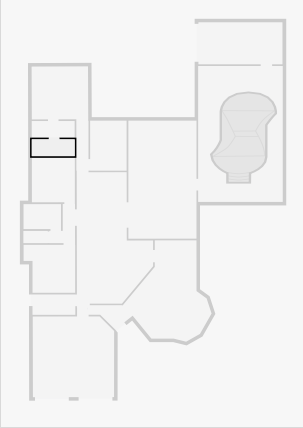

WIR

Width: 1.18 m
Length: 3.07 m
Area: 3.63 m²
Perimeter: 8.50 m

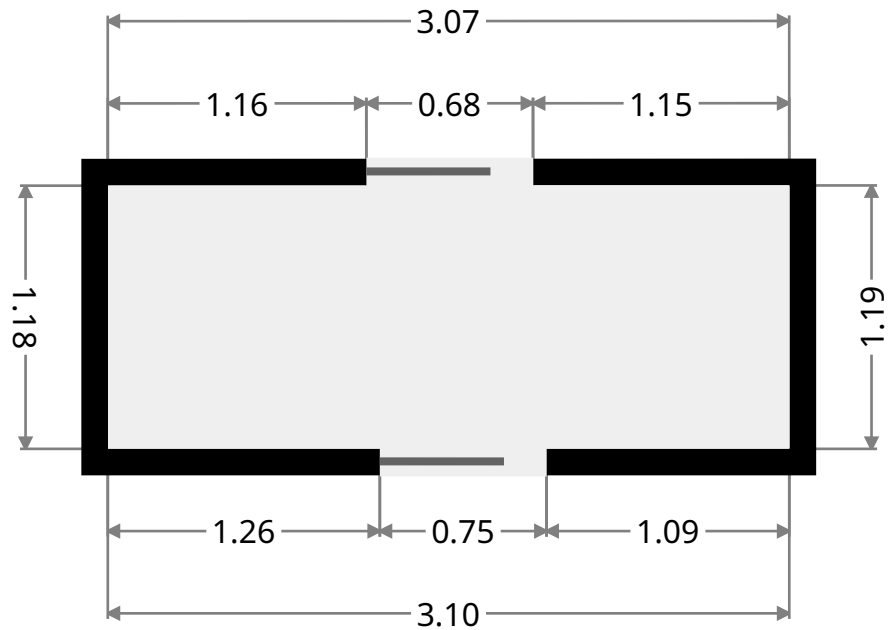
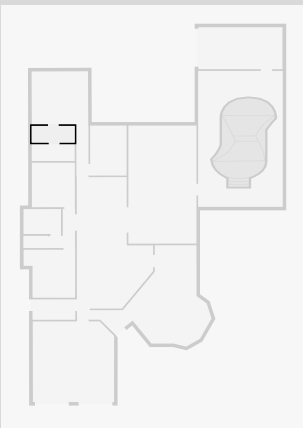

30 Rosewood Drive

Master Bedroom

Width: 3.78 m
Length: 4.03 m
Area: 15.22 m²
Perimeter: 15.61 m

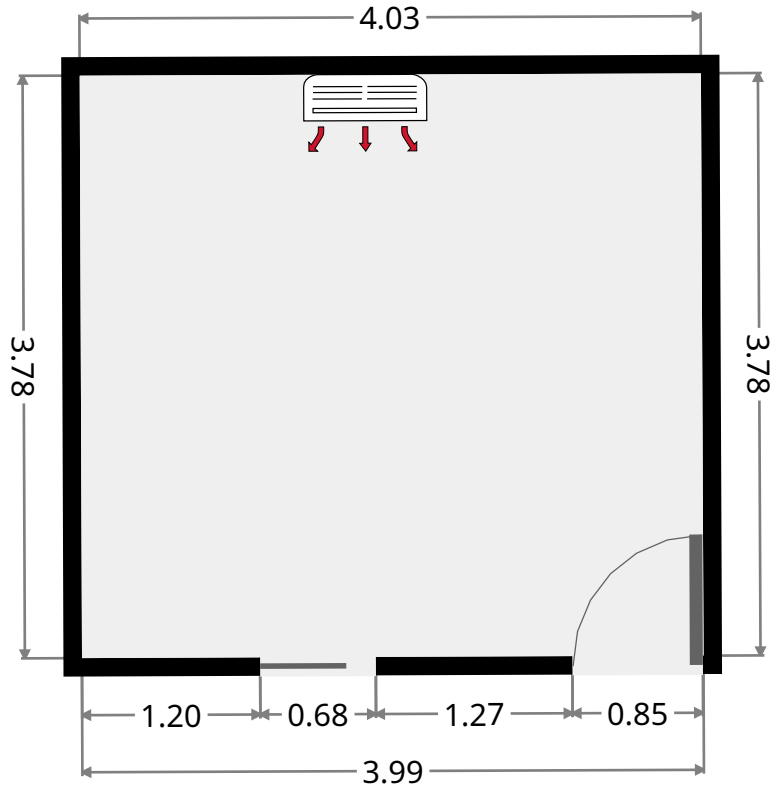
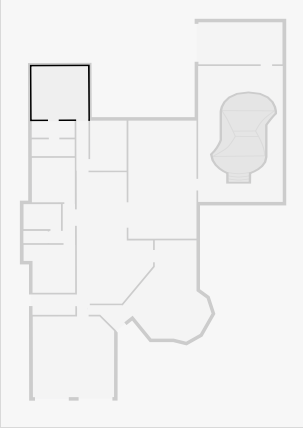

Bedroom

Width: 2.60 m
Length: 3.58 m
Area: 9.30 m²
Perimeter: 12.35 m

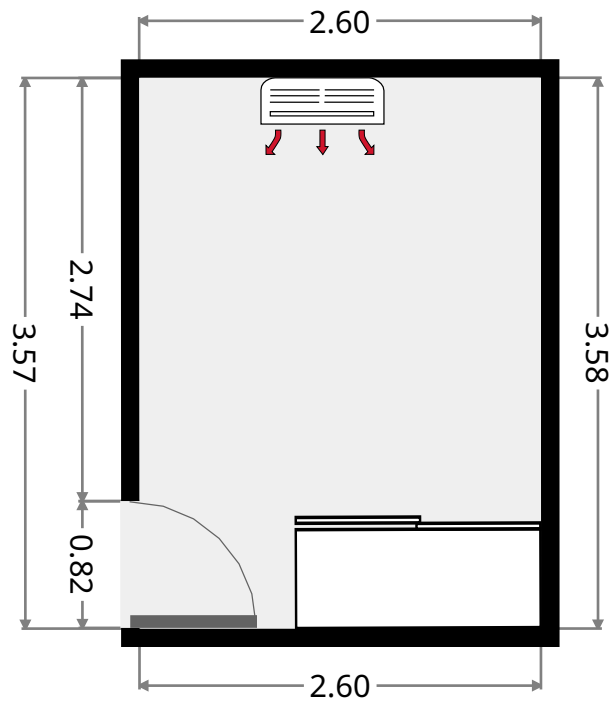
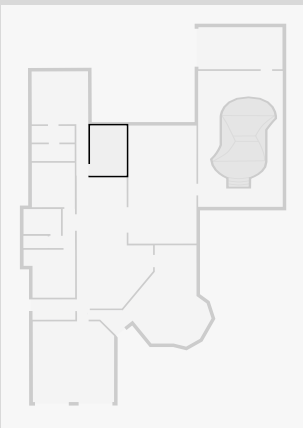

30 Rosewood Drive

Hall

Width: 0.86 m
 Length: 3.57 m
 Area: 3.09 m²
 Perimeter: 8.86 m

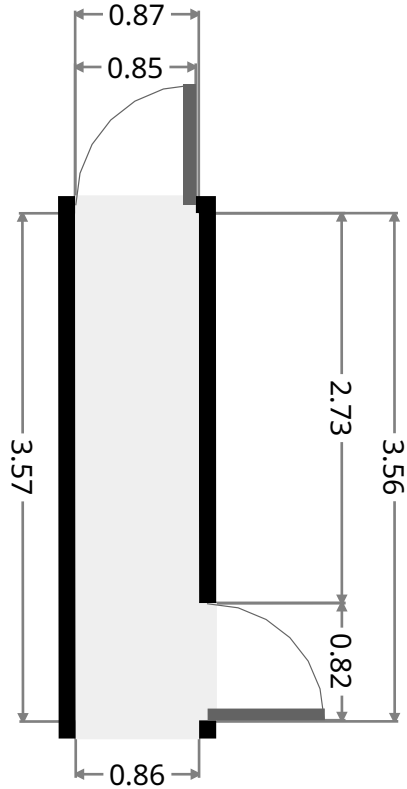
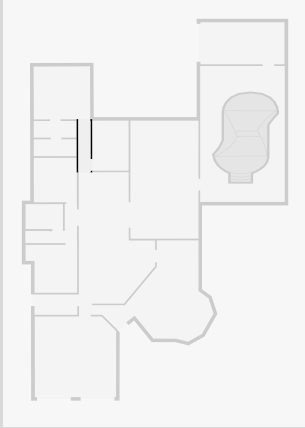

Hall

Width: 0.68 m
 Length: 3.21 m
 Area: 3.34 m²
 Perimeter: 9.57 m

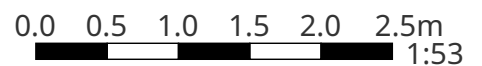
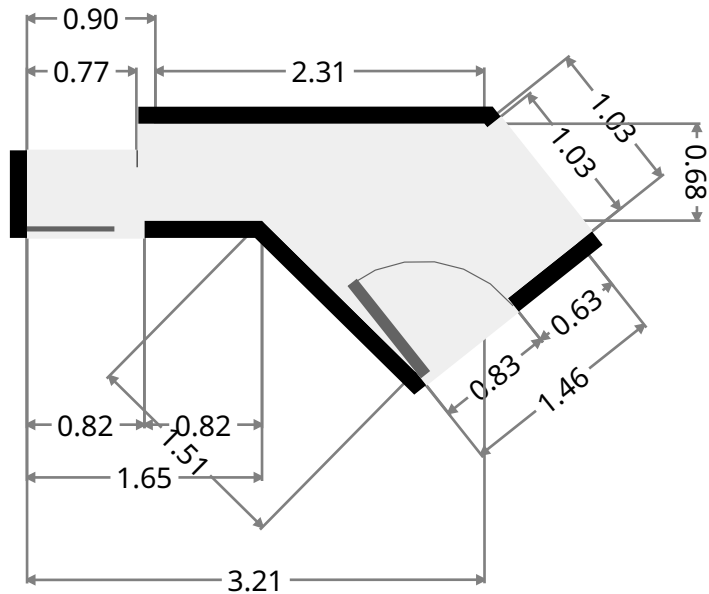
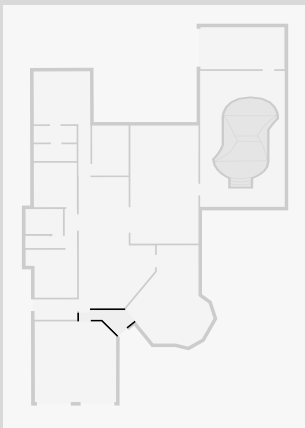

30 Rosewood Drive

Toilet

Width: 0.87 m
Length: 1.74 m
Area: 1.52 m²
Perimeter: 5.22 m

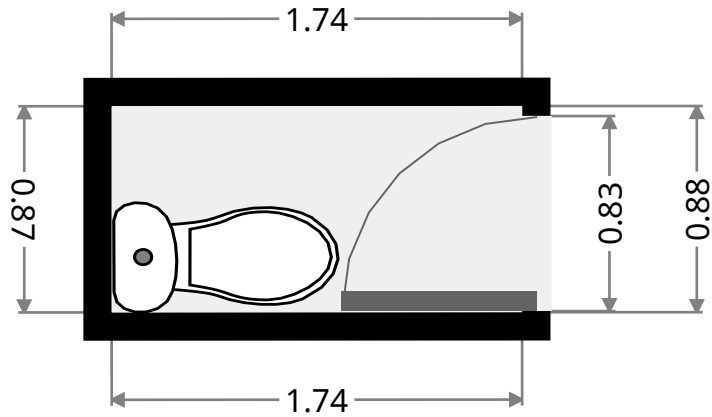
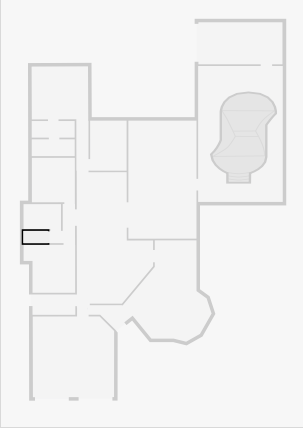

Bathroom

Width: 1.78 m
Length: 2.67 m
Area: 4.76 m²
Perimeter: 8.91 m

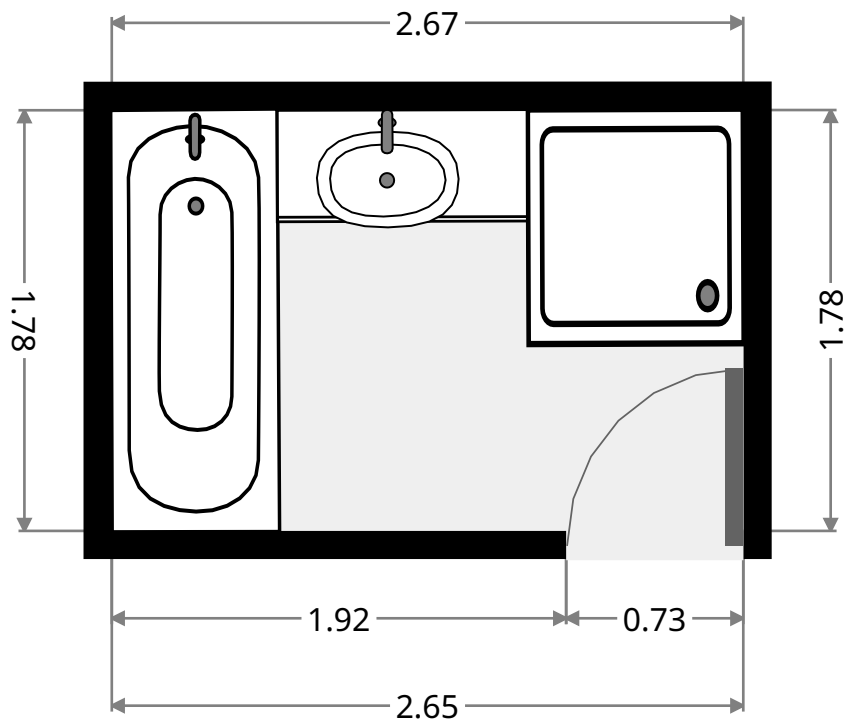
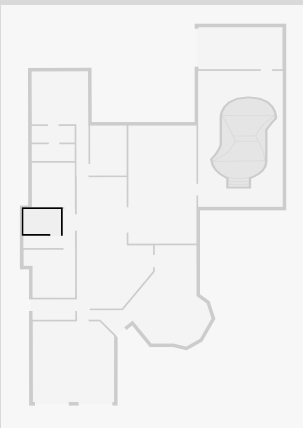

30 Rosewood Drive

Bedroom

Width: 3.07 m
 Length: 3.17 m
 Area: 9.74 m²
 Perimeter: 12.48 m

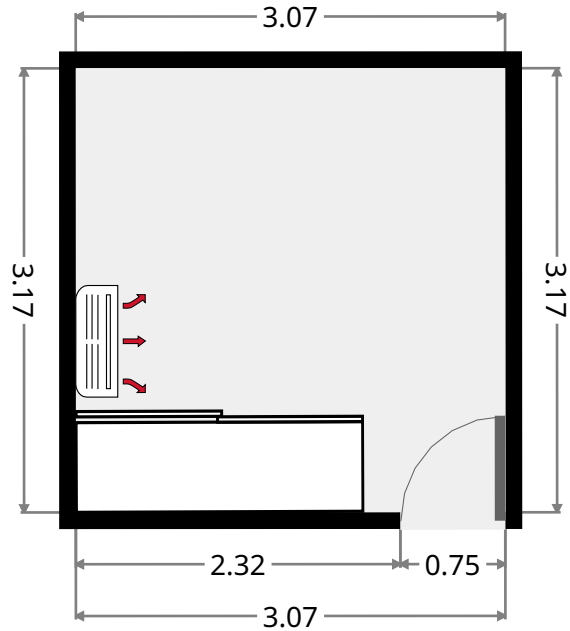
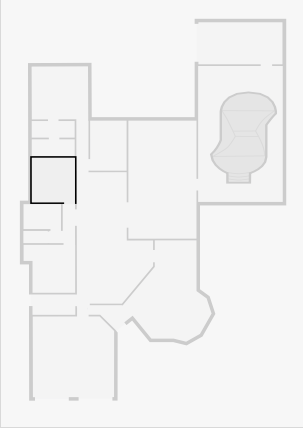

Hall

Width: 1.85 m
 Length: 2.80 m
 Area: 3.30 m²
 Perimeter: 9.28 m

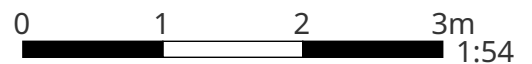
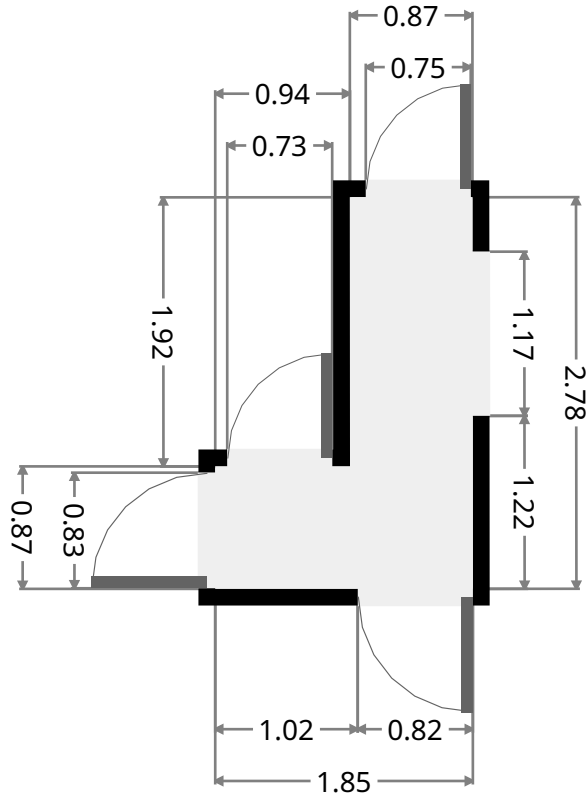
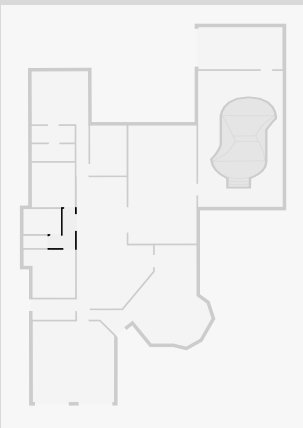

THIS FLOORPLAN IS PROVIDED WITHOUT WARRANTY OF ANY KIND. SENSOPIA DISCLAIMS ANY WARRANTY INCLUDING, WITHOUT LIMITATION, SATISFACTORY QUALITY OR ACCURACY OF DIMENSIONS.

30 Rosewood Drive

Laundry Room

Width: 1.46 m
 Length: 3.06 m
 Area: 4.44 m²
 Perimeter: 9.02 m

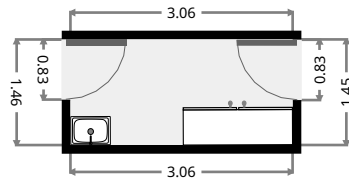
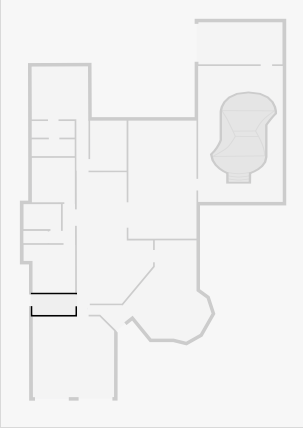

Kitchen/ 2nd Living

Width: 5.45 m
 Length: 9.68 m
 Area: 39.20 m²
 Perimeter: 28.83 m

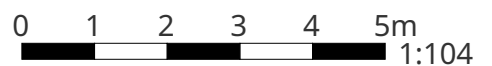
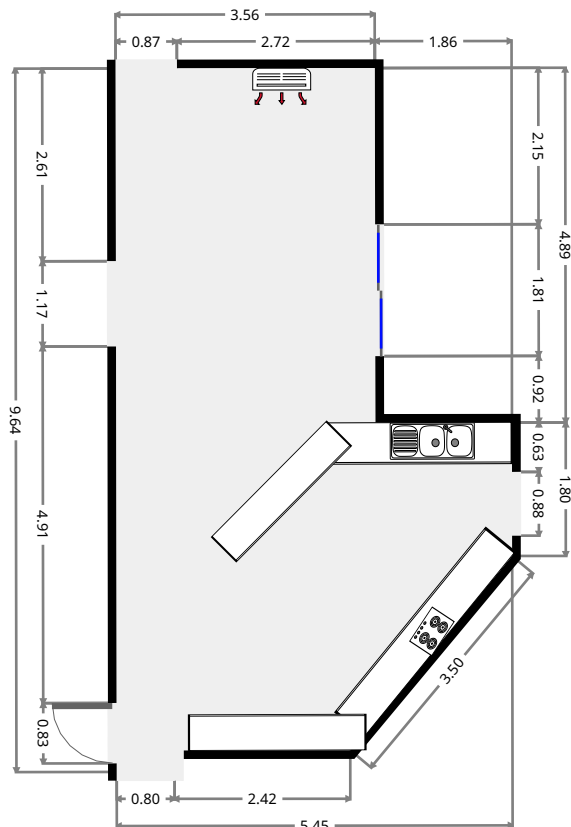
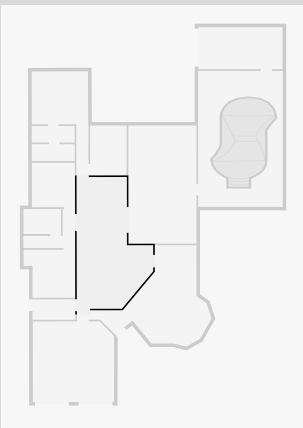

THIS FLOORPLAN IS PROVIDED WITHOUT WARRANTY OF ANY KIND. SENSOPIA DISCLAIMS ANY WARRANTY INCLUDING, WITHOUT LIMITATION, SATISFACTORY QUALITY OR ACCURACY OF DIMENSIONS.

30 Rosewood Drive

Living/Dining

Width: 3.22 m
 Length: 7.02 m
 Area: 29.18 m²
 Perimeter: 22.48 m

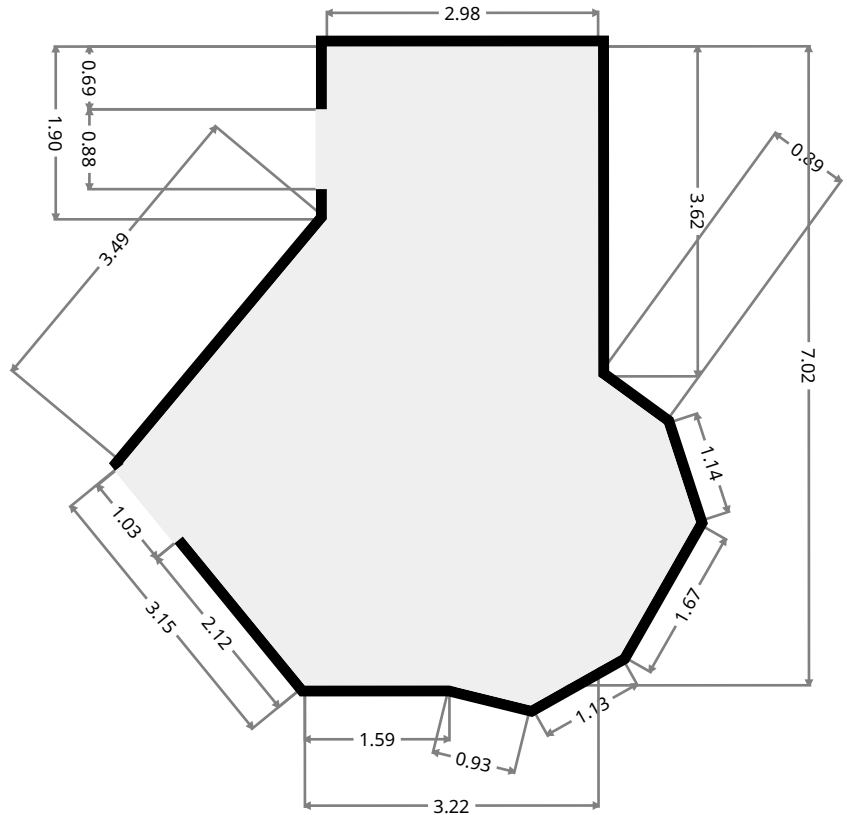
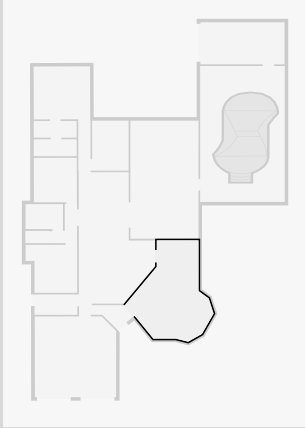

Garage

Width: 5.76 m
 Length: 5.81 m
 Area: 32.89 m²
 Perimeter: 22.52 m

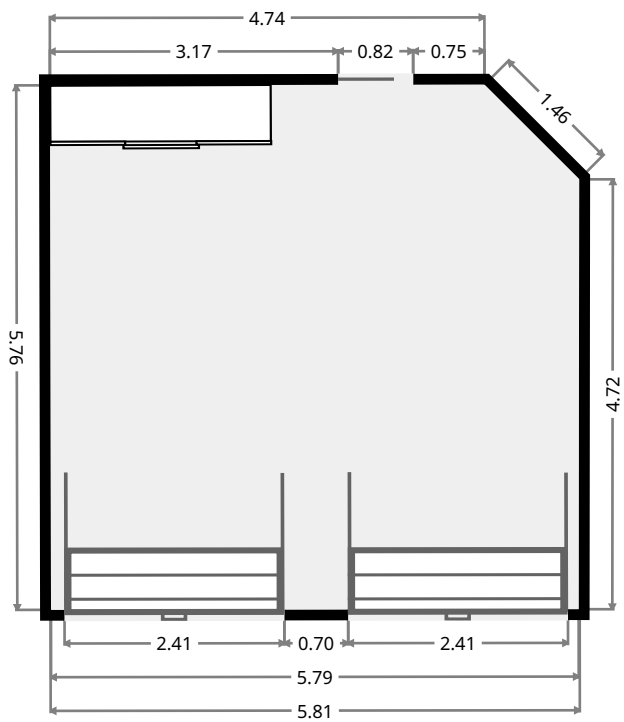
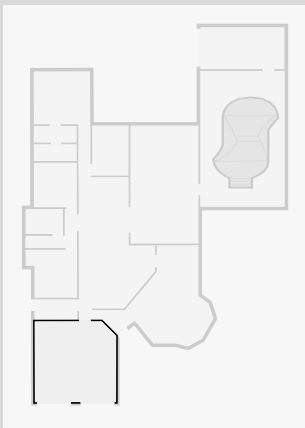

THIS FLOORPLAN IS PROVIDED WITHOUT WARRANTY OF ANY KIND. SENSOPIA DISCLAIMS ANY WARRANTY INCLUDING, WITHOUT LIMITATION, SATISFACTORY QUALITY OR ACCURACY OF DIMENSIONS.