

# 3 Athelstane Street

## Ground Floor

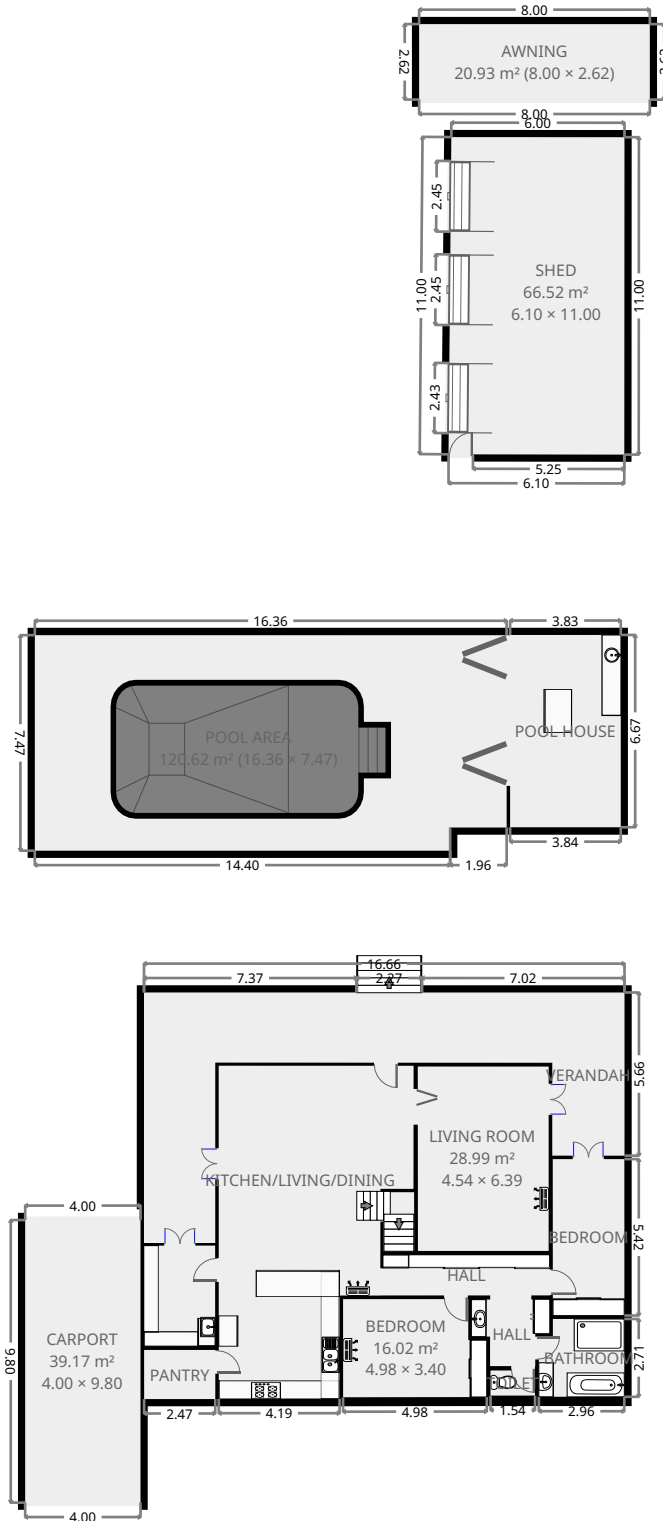

THIS FLOORPLAN IS PROVIDED WITHOUT WARRANTY OF ANY KIND. SENSOPIA DISCLAIMS ANY WARRANTY INCLUDING, WITHOUT LIMITATION, SATISFACTORY QUALITY OR ACCURACY OF DIMENSIONS.



# 3 Athelstane Street

## Bedroom

Width: 2.48 m  
Length: 5.42 m  
Area: 13.45 m<sup>2</sup>  
Perimeter: 15.81 m

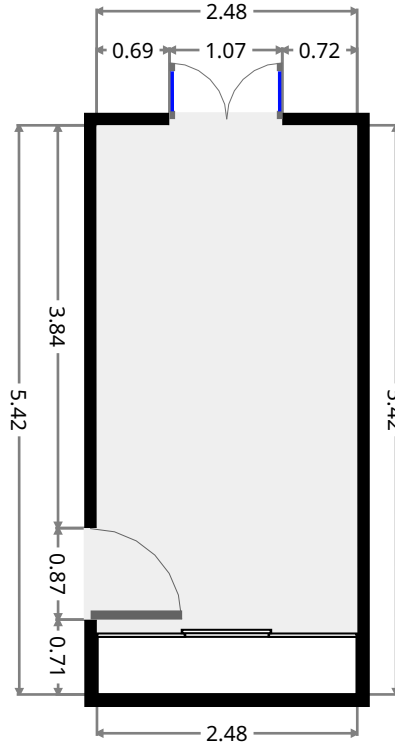
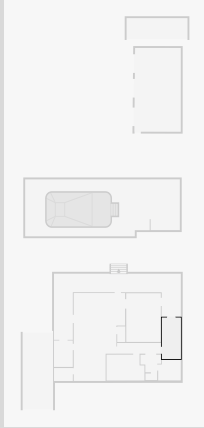

## Awning

Width: 2.62 m  
Length: 8.00 m  
Area: 20.93 m<sup>2</sup>  
Perimeter: 21.23 m

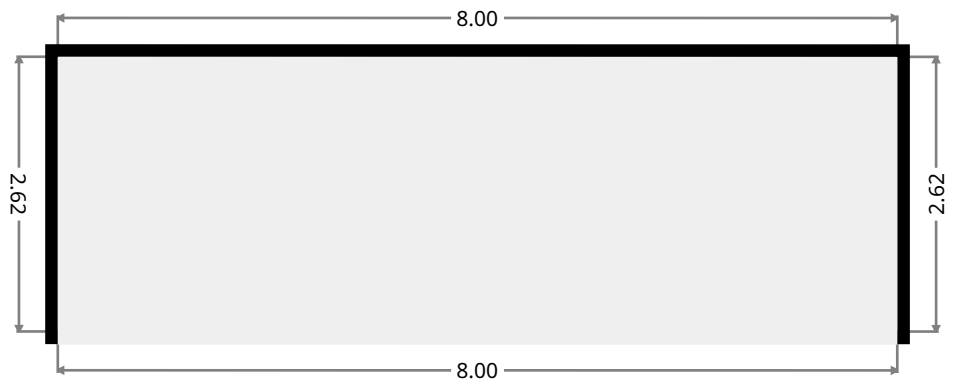
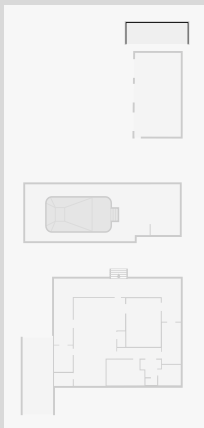

# 3 Athelstane Street

## Shed

Width: 6.10 m  
Length: 11.00 m  
Area: 66.52 m<sup>2</sup>  
Perimeter: 34.10 m

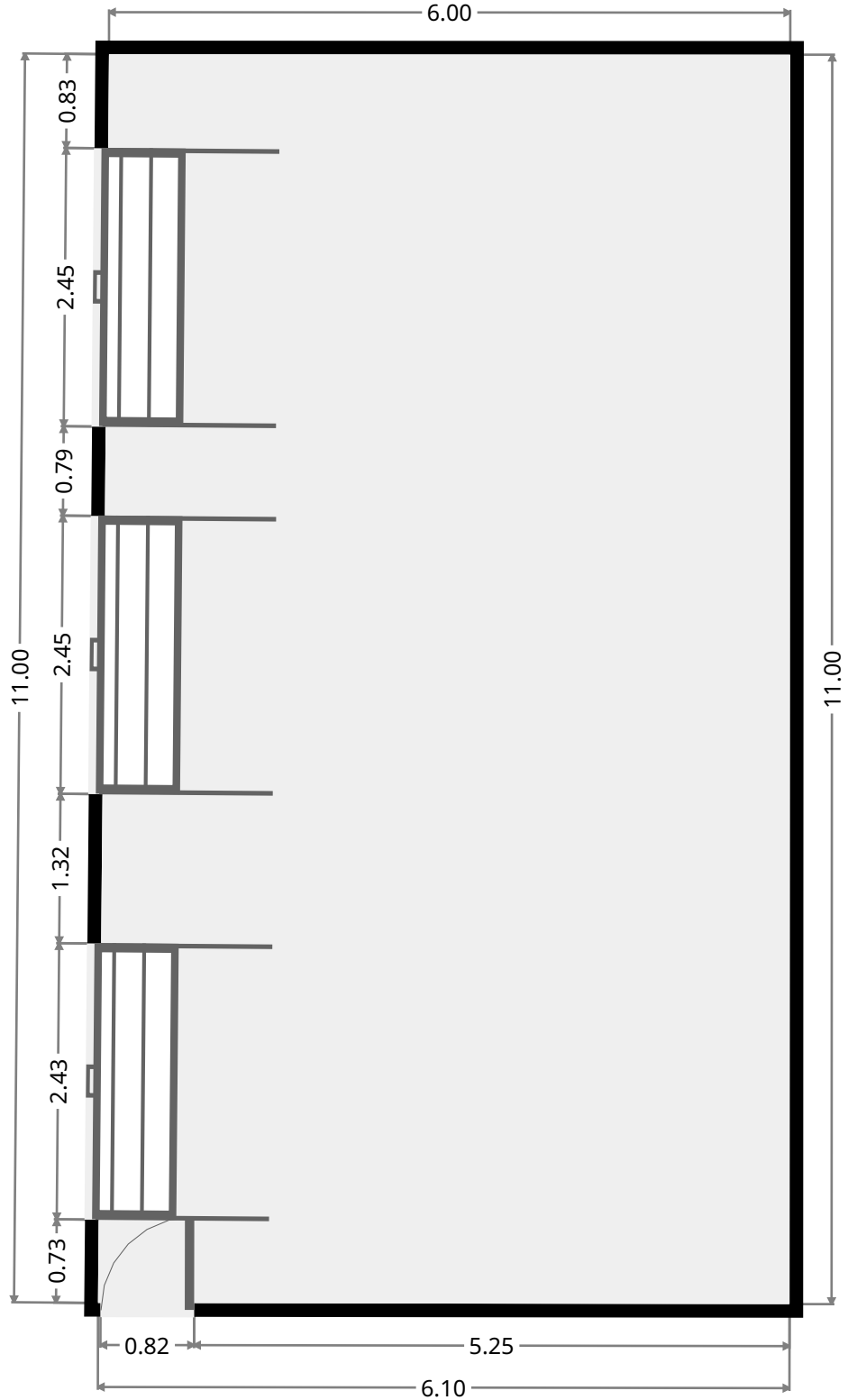
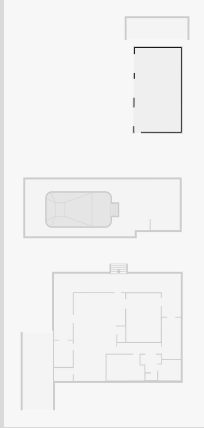

THIS FLOORPLAN IS PROVIDED WITHOUT WARRANTY OF ANY KIND. SENSOPIA DISCLAIMS ANY WARRANTY INCLUDING, WITHOUT LIMITATION, SATISFACTORY QUALITY OR ACCURACY OF DIMENSIONS.

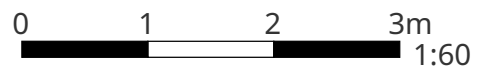

# 3 Athelstane Street

## Pool Area

Width: 7.47 m  
Length: 16.36 m  
Area: 120.62 m<sup>2</sup>  
Perimeter: 47.66 m

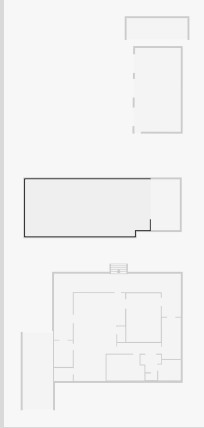

# 3 Athelstane Street

## Pool House

Width: 3.83 m  
Length: 6.67 m  
Area: 25.57 m<sup>2</sup>  
Perimeter: 21.00 m

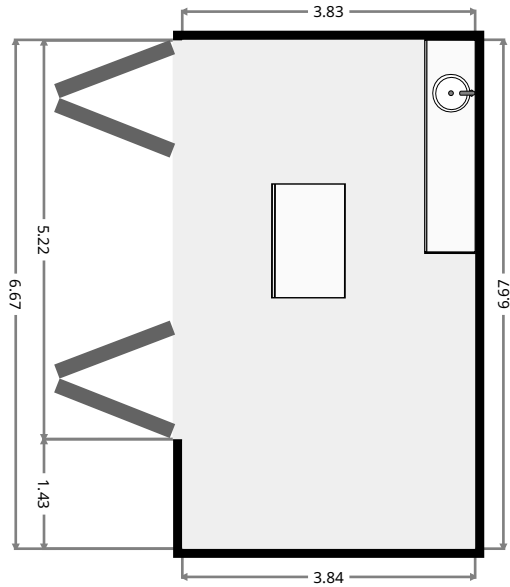
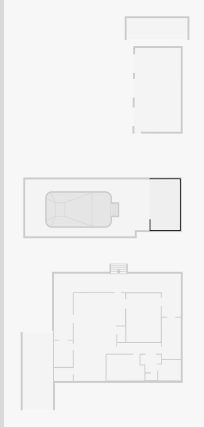

## Carport

Width: 4.00 m  
Length: 9.80 m  
Area: 39.17 m<sup>2</sup>  
Perimeter: 27.59 m

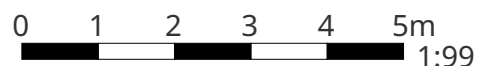
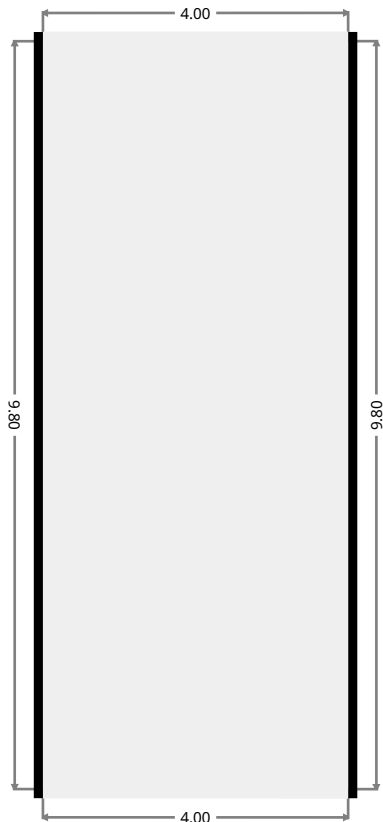
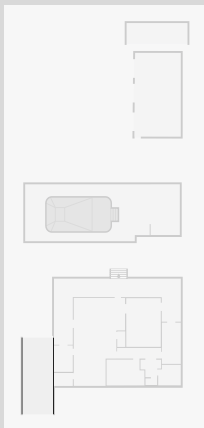

# 3 Athelstane Street

## Verandah

Width: 8.69 m  
Length: 16.66 m  
Area: 64.05 m<sup>2</sup>  
Perimeter: 57.14 m

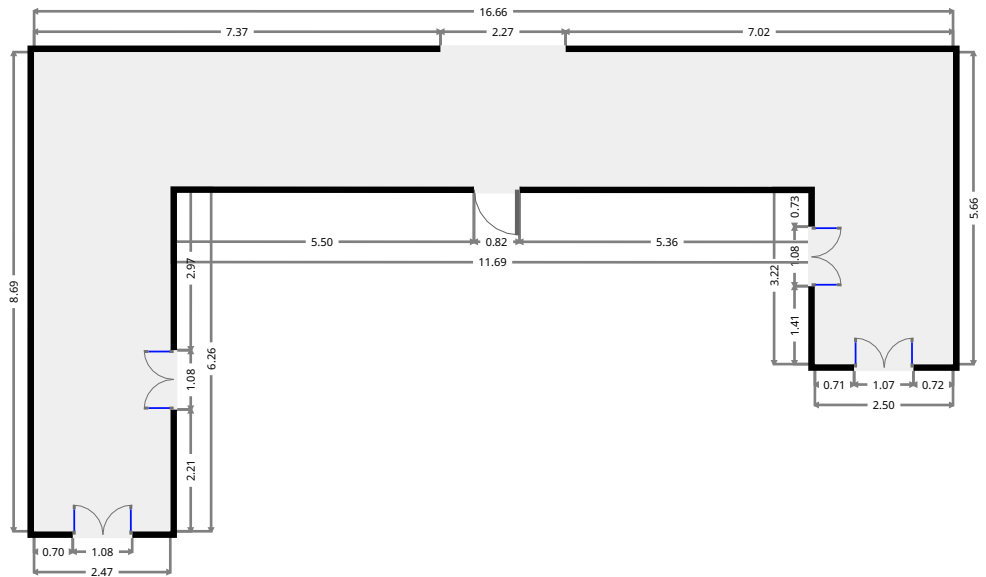
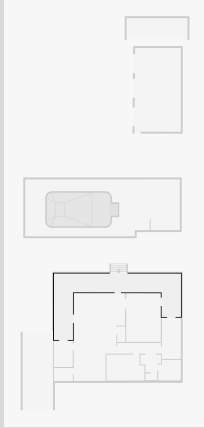

THIS FLOORPLAN IS PROVIDED WITHOUT WARRANTY OF ANY KIND. SENSOPIA DISCLAIMS ANY WARRANTY INCLUDING, WITHOUT LIMITATION, SATISFACTORY QUALITY OR ACCURACY OF DIMENSIONS.



# 3 Athelstane Street

## Stairway

Width: 1.06 m  
 Length: 2.05 m  
 Area: 2.17 m<sup>2</sup>  
 Perimeter: 6.21 m

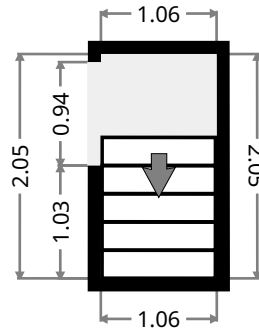
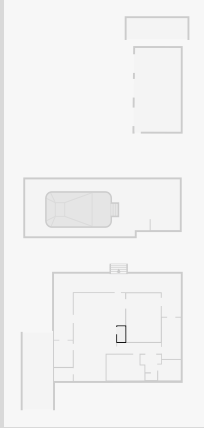

## Living Room

Width: 4.54 m  
 Length: 6.39 m  
 Area: 28.99 m<sup>2</sup>  
 Perimeter: 21.85 m

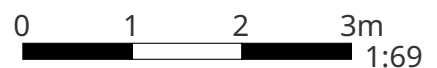
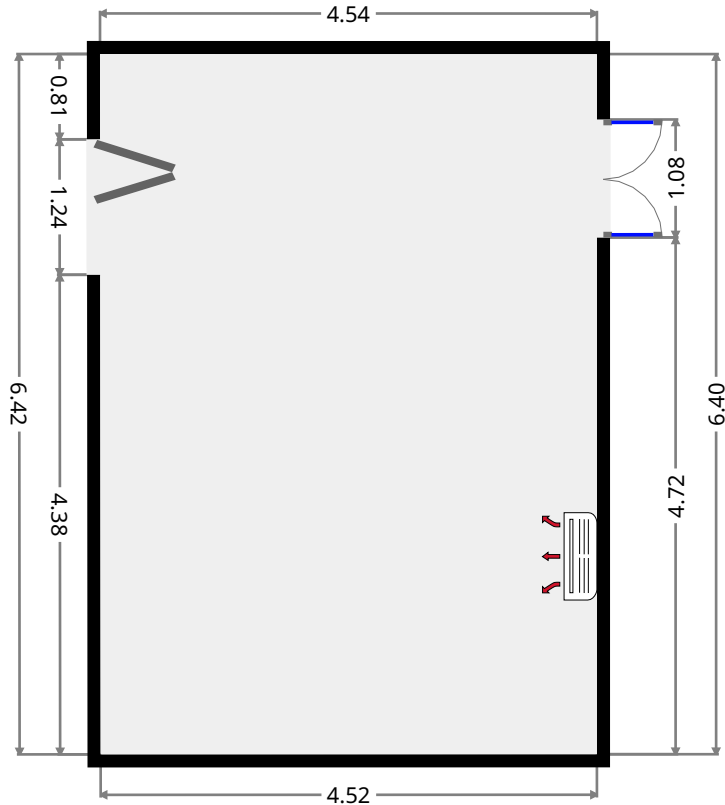
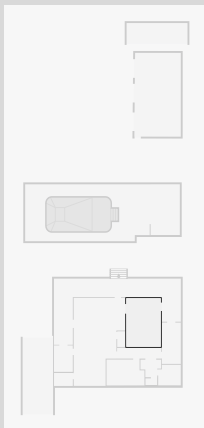

THIS FLOORPLAN IS PROVIDED WITHOUT WARRANTY OF ANY KIND. SENSOPIA DISCLAIMS ANY WARRANTY INCLUDING, WITHOUT LIMITATION, SATISFACTORY QUALITY OR ACCURACY OF DIMENSIONS.

# 3 Athelstane Street

## Kitchen/Living/Dining

Width: 6.76 m  
 Length: 11.55 m  
 Area: 64.54 m<sup>2</sup>  
 Perimeter: 36.59 m

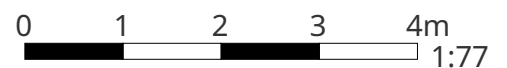
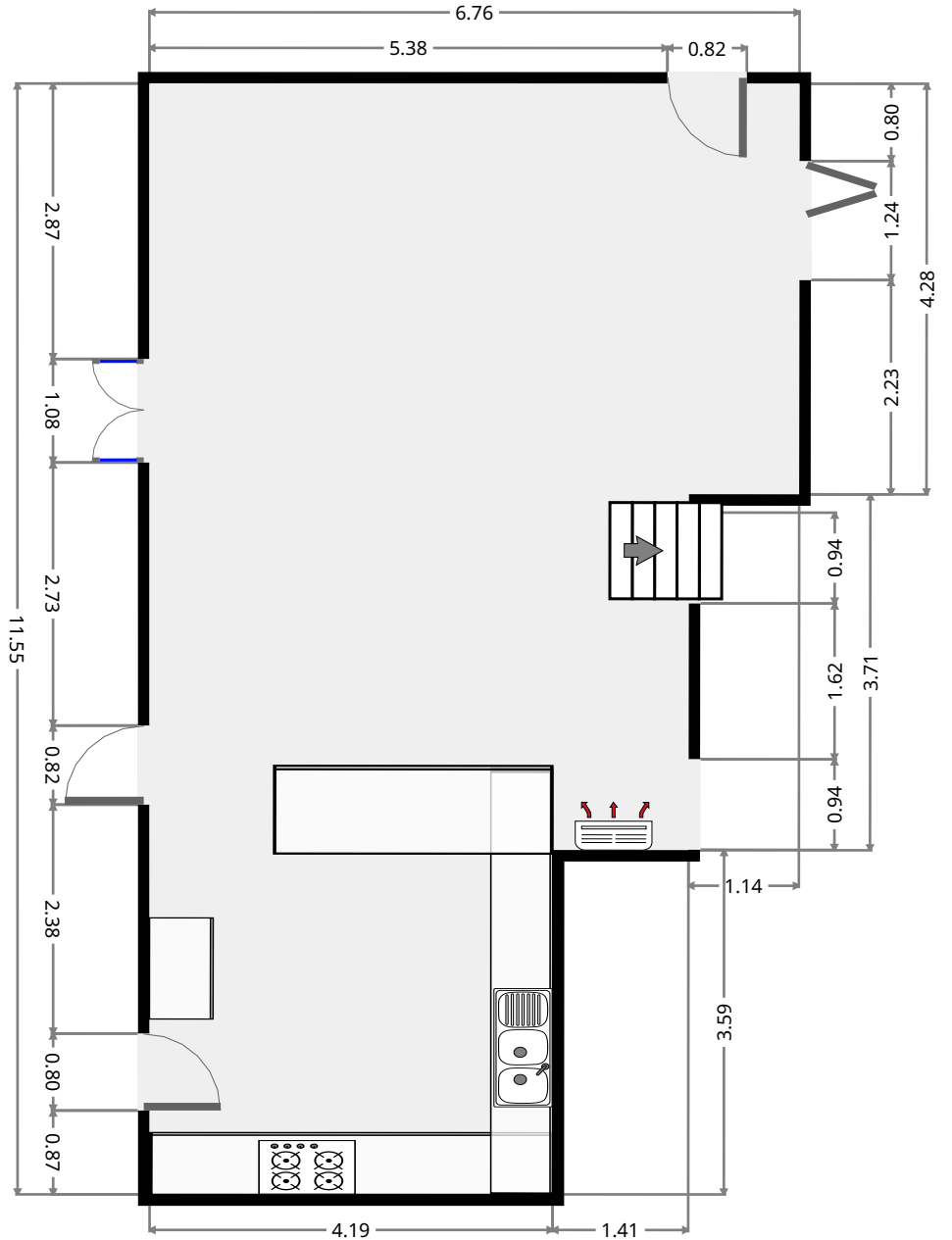
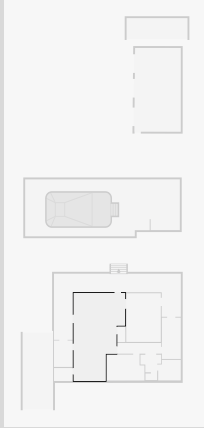

THIS FLOORPLAN IS PROVIDED WITHOUT WARRANTY OF ANY KIND. SENSOPIA DISCLAIMS ANY WARRANTY INCLUDING, WITHOUT LIMITATION, SATISFACTORY QUALITY OR ACCURACY OF DIMENSIONS.



# 3 Athelstane Street

## Bathroom

Width: 2.71 m  
 Length: 2.96 m  
 Area: 7.69 m<sup>2</sup>  
 Perimeter: 11.32 m

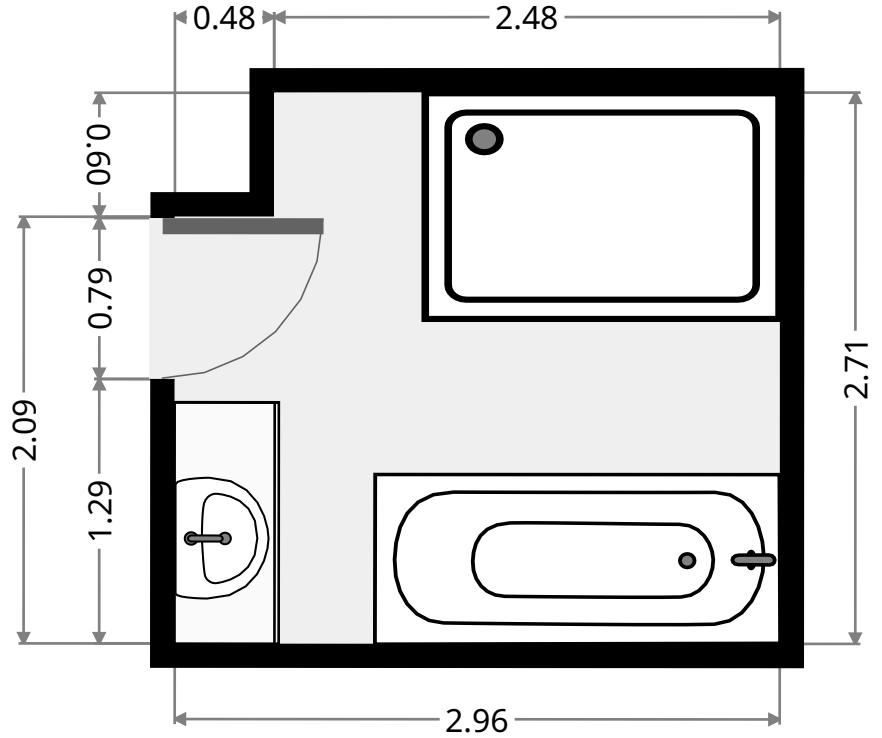
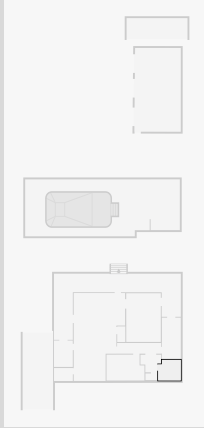

## Toilet

Width: 0.86 m  
 Length: 1.54 m  
 Area: 1.34 m<sup>2</sup>  
 Perimeter: 4.82 m

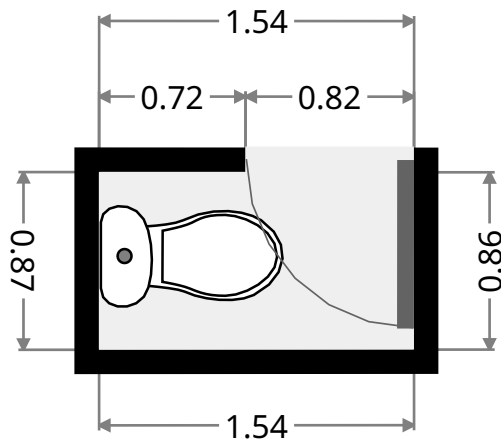
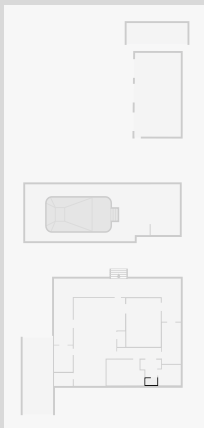

# 3 Athelstane Street

## Hall

Width: 2.31 m  
 Length: 2.72 m  
 Area: 5.04 m<sup>2</sup>  
 Perimeter: 10.05 m

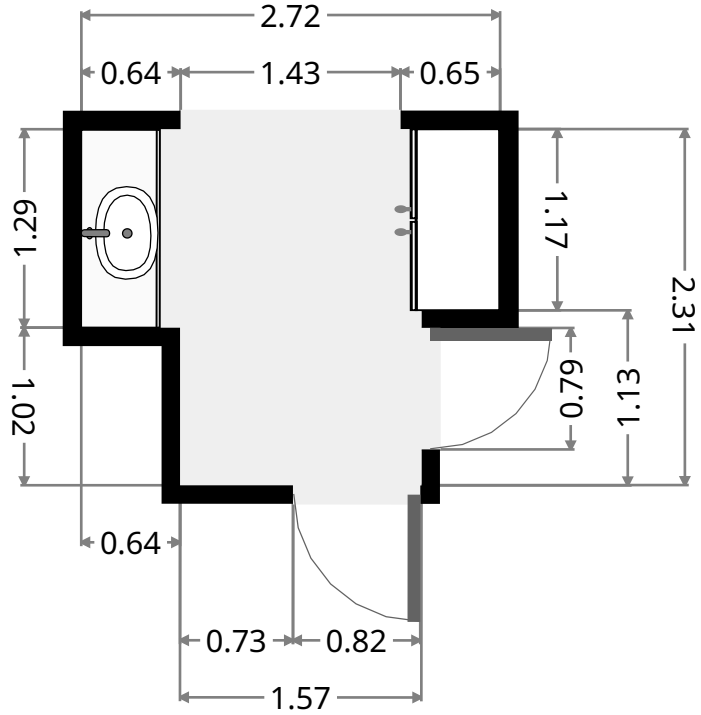
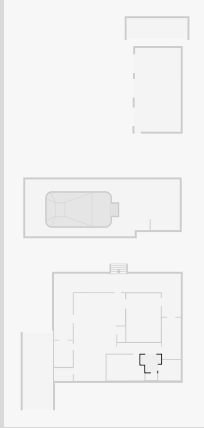

## Bedroom

Width: 3.40 m  
 Length: 4.98 m  
 Area: 16.02 m<sup>2</sup>  
 Perimeter: 16.76 m

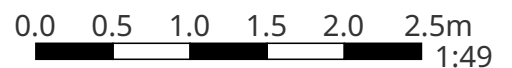
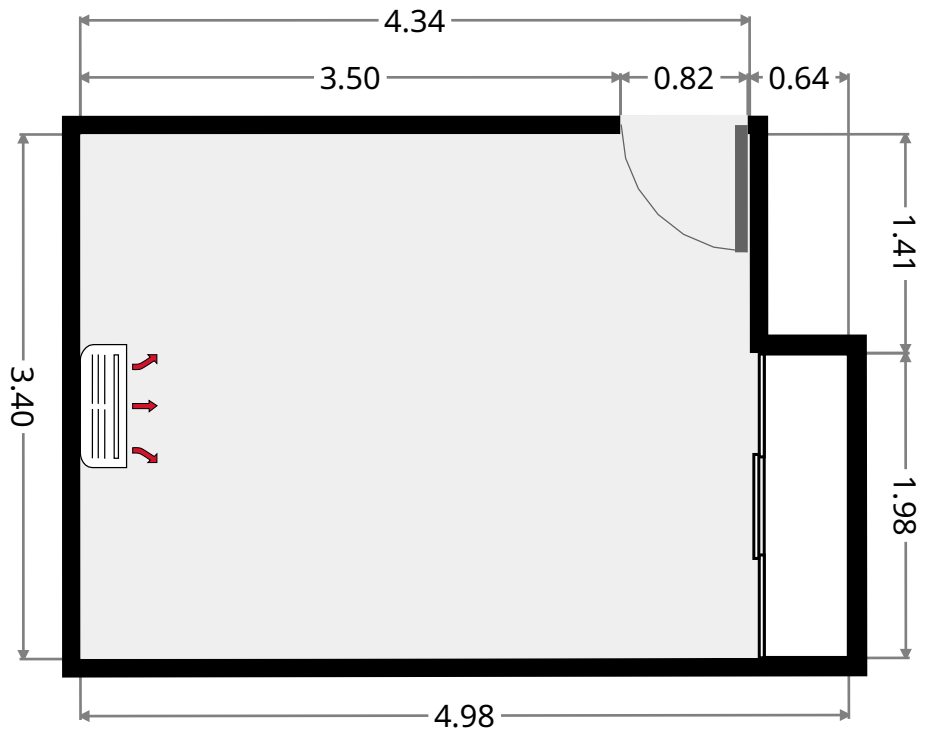
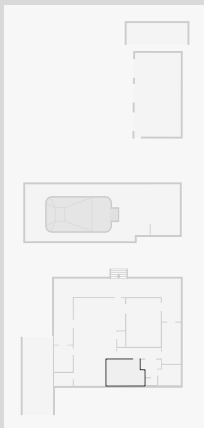

THIS FLOORPLAN IS PROVIDED WITHOUT WARRANTY OF ANY KIND. SENSOPIA DISCLAIMS ANY WARRANTY INCLUDING, WITHOUT LIMITATION, SATISFACTORY QUALITY OR ACCURACY OF DIMENSIONS.

# 3 Athelstane Street

## Hall

Width: 1.39 m  
 Length: 5.78 m  
 Area: 8.11 m<sup>2</sup>  
 Perimeter: 14.37 m

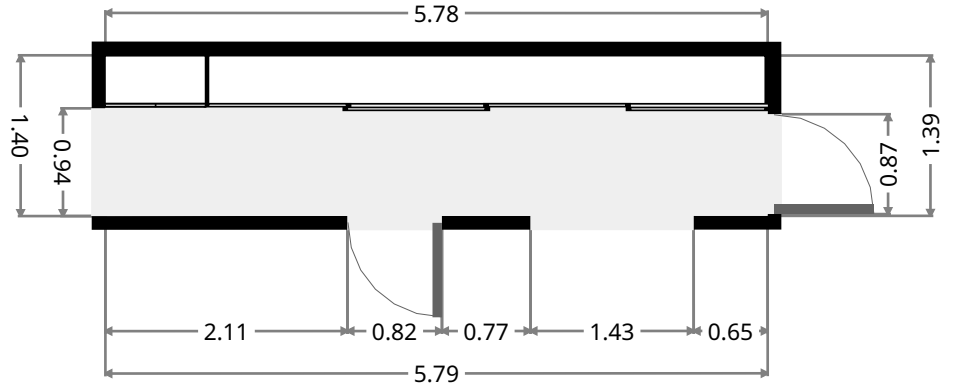
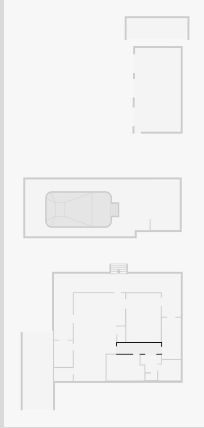

## Pantry

Width: 1.70 m  
 Length: 2.47 m  
 Area: 4.20 m<sup>2</sup>  
 Perimeter: 8.34 m

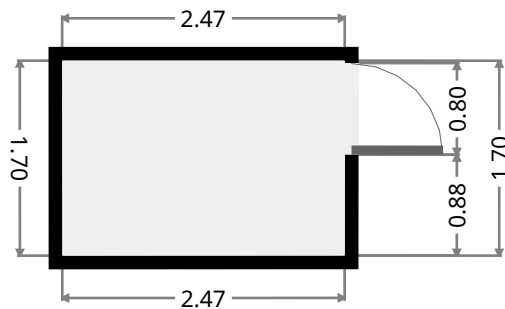
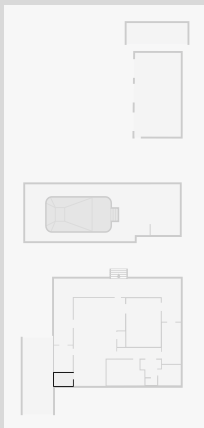

# 3 Athelstane Street

## Laundry Room

Width: 2.47 m  
Length: 3.47 m  
Area: 8.55 m<sup>2</sup>  
Perimeter: 11.87 m

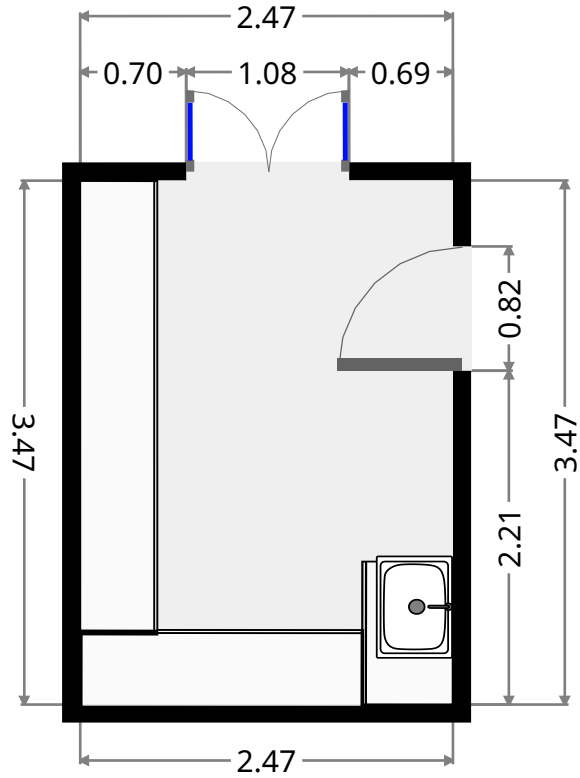
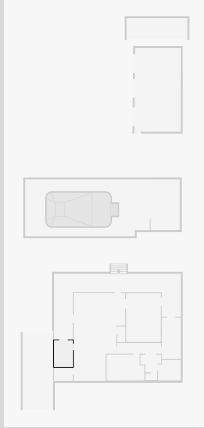

# 3 Athelstane Street

## 1st Floor

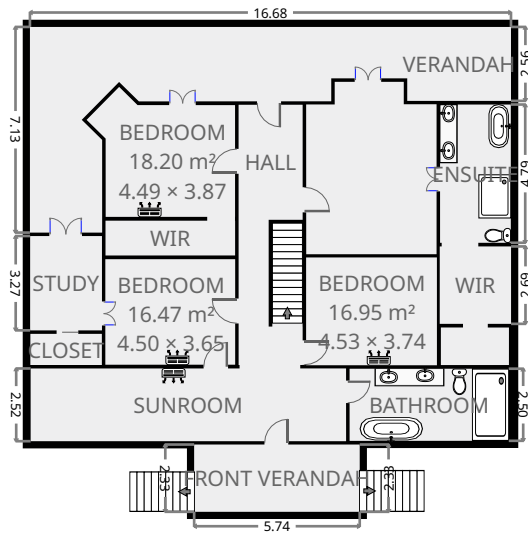

THIS FLOORPLAN IS PROVIDED WITHOUT WARRANTY OF ANY KIND. SENSOPIA DISCLAIMS ANY WARRANTY INCLUDING, WITHOUT LIMITATION, SATISFACTORY QUALITY OR ACCURACY OF DIMENSIONS.

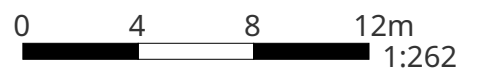

# 3 Athelstane Street

## Sunroom

Width: 2.53 m  
Length: 10.94 m  
Area: 27.58 m<sup>2</sup>  
Perimeter: 26.92 m

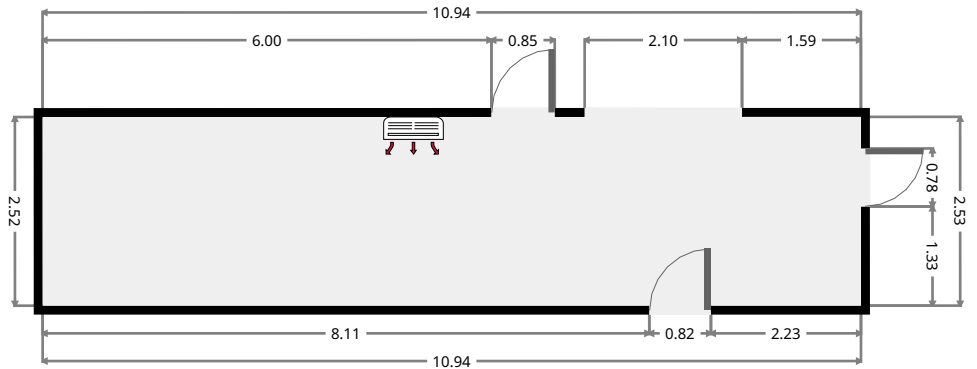
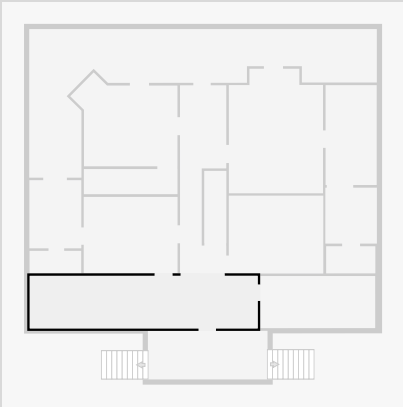

# 3 Athelstane Street

## Bathroom

Width: 2.50 m  
 Length: 5.52 m  
 Area: 13.80 m<sup>2</sup>  
 Perimeter: 16.04 m

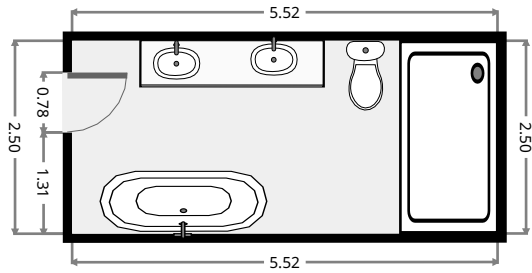
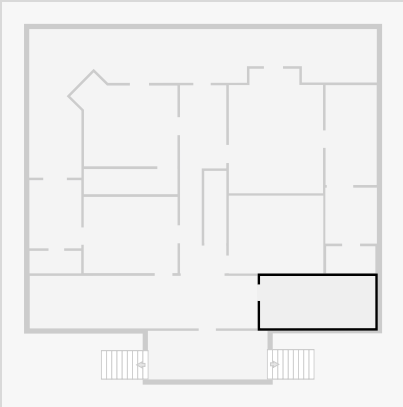

## Hall

Width: 2.22 m  
 Length: 9.02 m  
 Area: 15.66 m<sup>2</sup>  
 Perimeter: 24.84 m

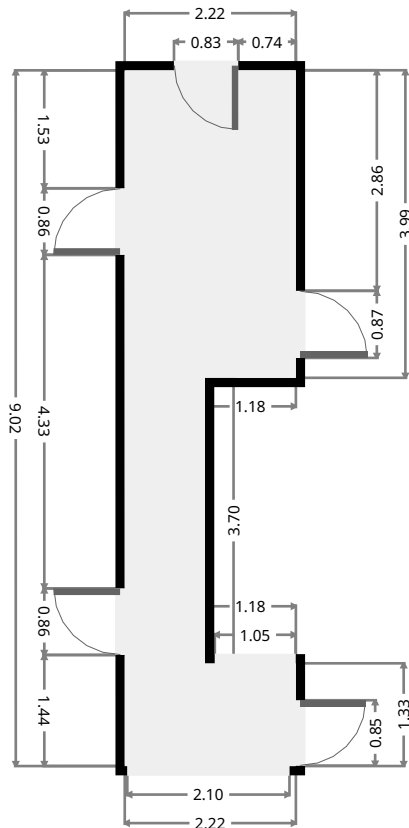
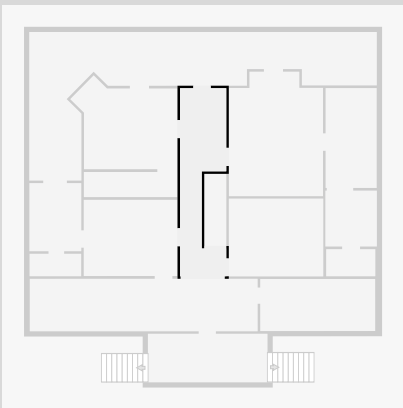

THIS FLOORPLAN IS PROVIDED WITHOUT WARRANTY OF ANY KIND. SENSOPIA DISCLAIMS ANY WARRANTY INCLUDING, WITHOUT LIMITATION, SATISFACTORY QUALITY OR ACCURACY OF DIMENSIONS.

# 3 Athelstane Street

## Stairway

Width:	1.06 m
Length:	3.47 m
Area	3.68 m <sup>2</sup>
Perimeter	9.06 m

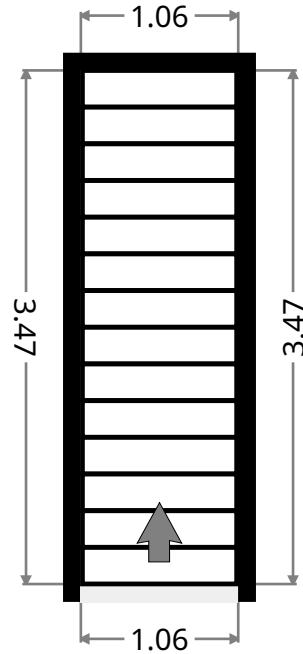
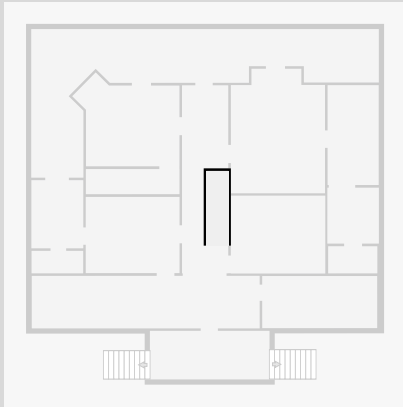

## Bedroom

Width:	3.65 m
Length:	4.50 m
Area	16.47 m <sup>2</sup>
Perimeter	16.32 m

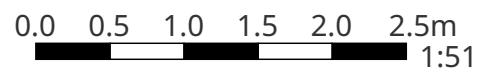
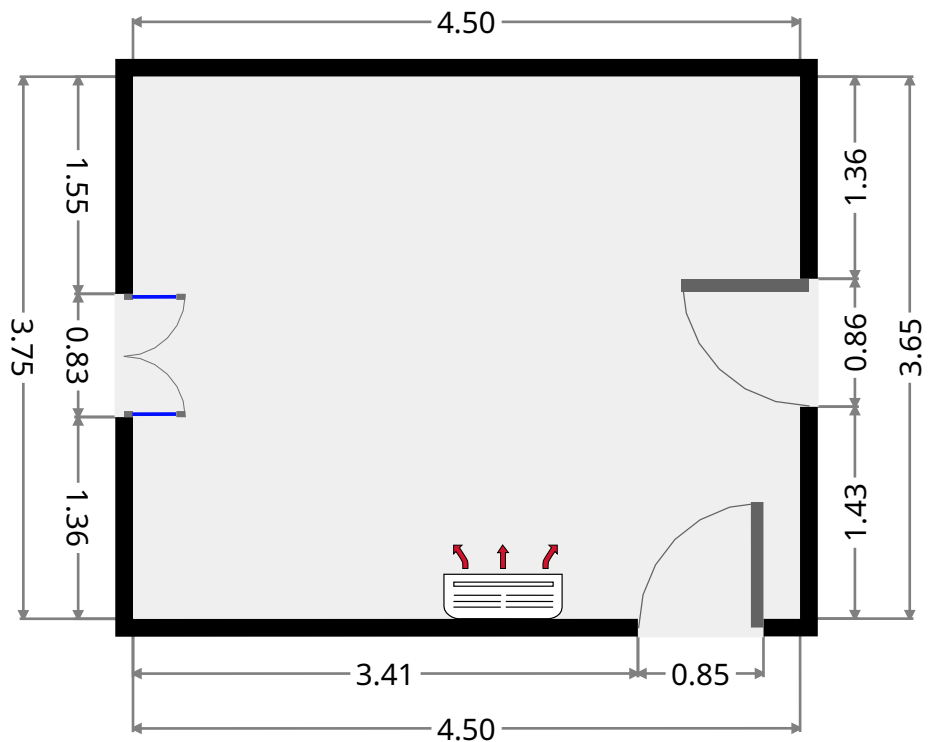
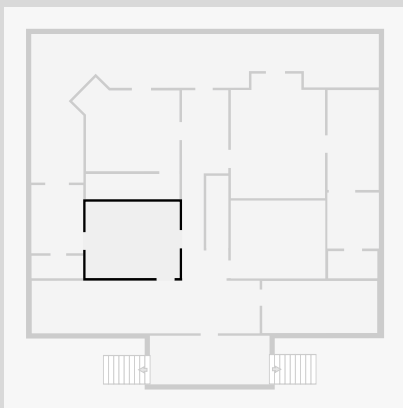

THIS FLOORPLAN IS PROVIDED WITHOUT WARRANTY OF ANY KIND. SENSOPIA DISCLAIMS ANY WARRANTY INCLUDING, WITHOUT LIMITATION, SATISFACTORY QUALITY OR ACCURACY OF DIMENSIONS.



# 3 Athelstane Street

## Study

Width: 2.49 m  
 Length: 3.27 m  
 Area: 8.14 m<sup>2</sup>  
 Perimeter: 11.52 m

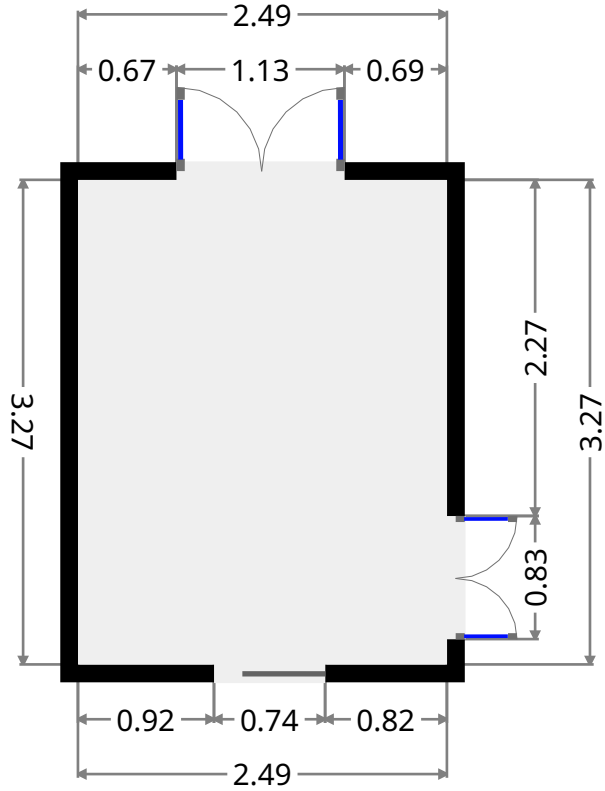
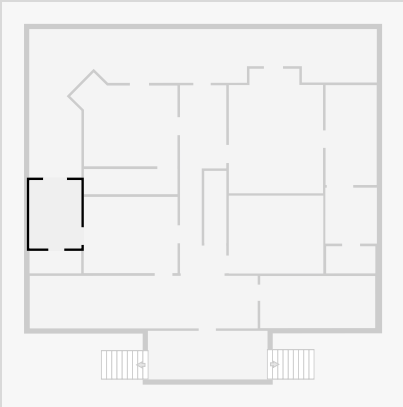

## Closet

Width: 1.08 m  
 Length: 2.48 m  
 Area: 2.68 m<sup>2</sup>  
 Perimeter: 7.12 m

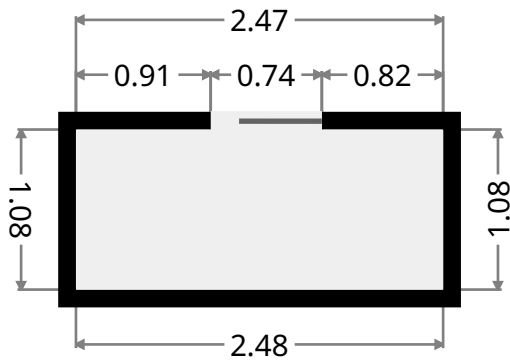
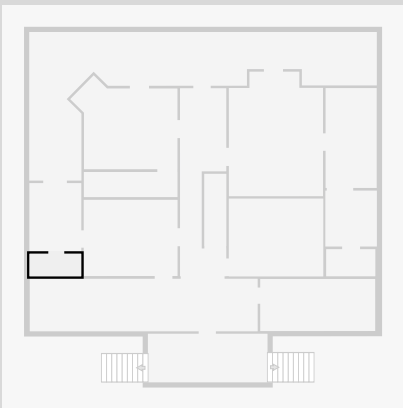

# 3 Athelstane Street

## Bedroom

Width: 3.74 m  
 Length: 4.53 m  
 Area: 16.95 m<sup>2</sup>  
 Perimeter: 16.54 m

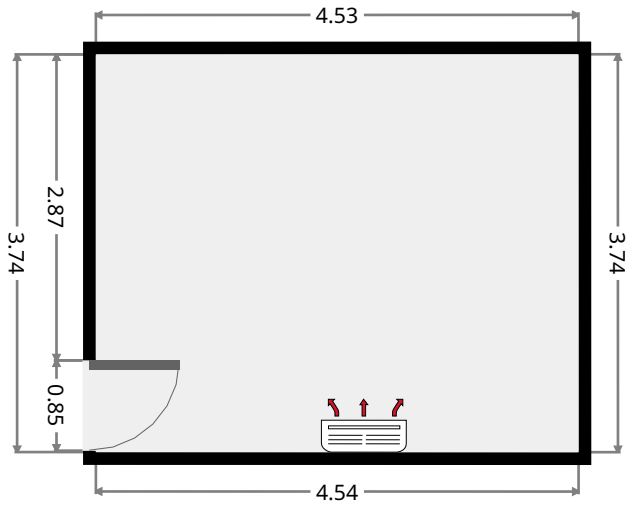
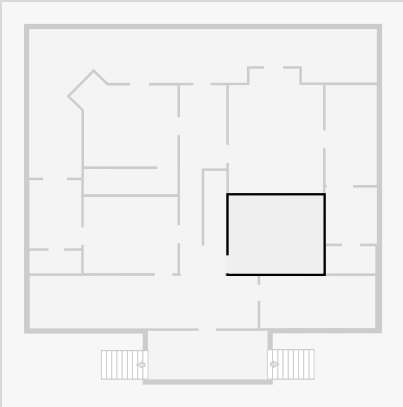

## Master Bedroom

Width: 4.52 m  
 Length: 5.98 m  
 Area: 25.35 m<sup>2</sup>  
 Perimeter: 20.99 m

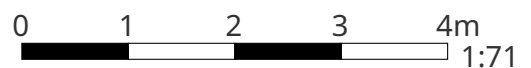
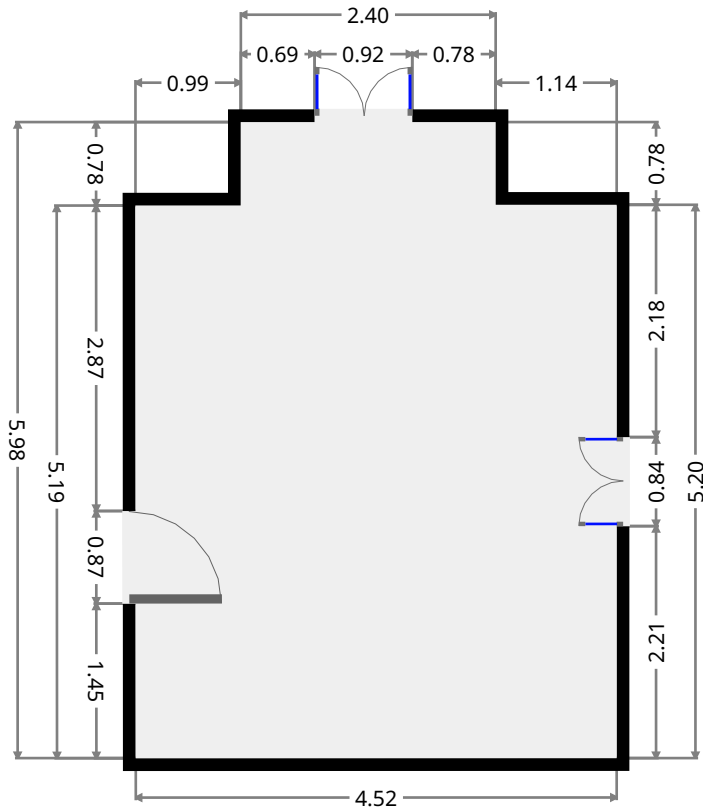
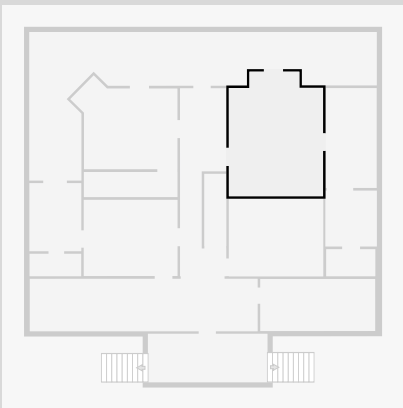

THIS FLOORPLAN IS PROVIDED WITHOUT WARRANTY OF ANY KIND. SENSOPIA DISCLAIMS ANY WARRANTY INCLUDING, WITHOUT LIMITATION, SATISFACTORY QUALITY OR ACCURACY OF DIMENSIONS.

# 3 Athelstane Street

## Ensuite

Width: 2.45 m  
 Length: 4.79 m  
 Area: 11.75 m<sup>2</sup>  
 Perimeter: 14.49 m

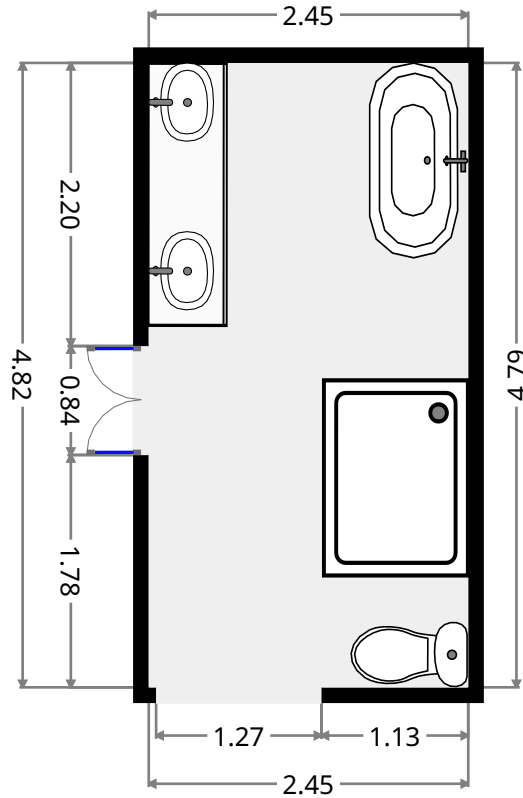
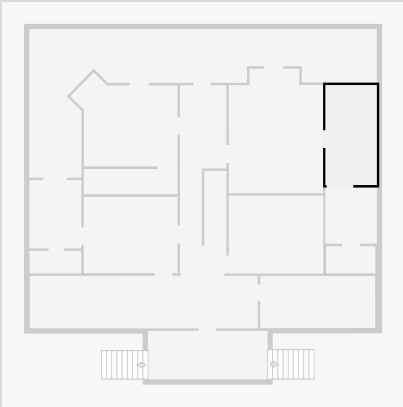

## WIR

Width: 2.47 m  
 Length: 2.69 m  
 Area: 6.63 m<sup>2</sup>  
 Perimeter: 10.31 m

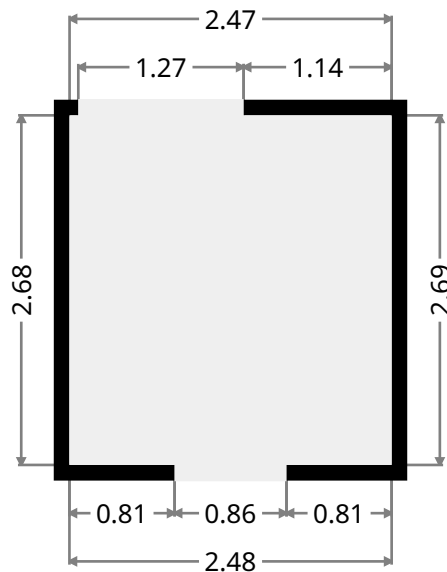
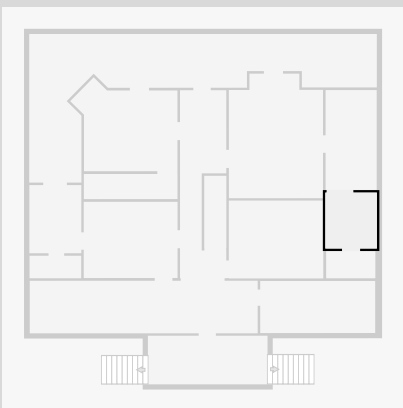

# 3 Athelstane Street

## Powder Room

Width: 1.30 m  
 Length: 2.36 m  
 Area: 3.07 m<sup>2</sup>  
 Perimeter: 7.32 m

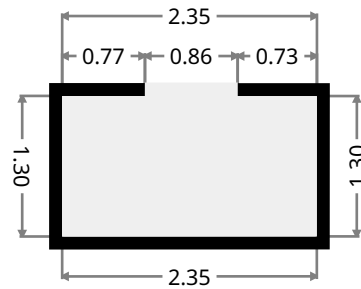
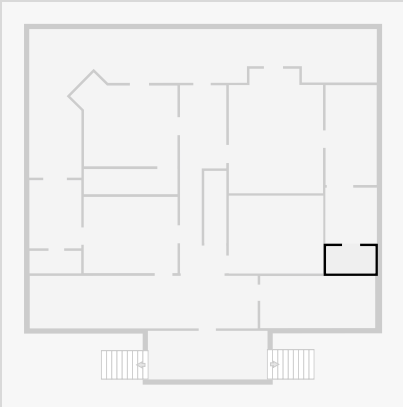

## Bedroom

Width: 3.87 m  
 Length: 4.49 m  
 Area: 18.20 m<sup>2</sup>  
 Perimeter: 17.88 m

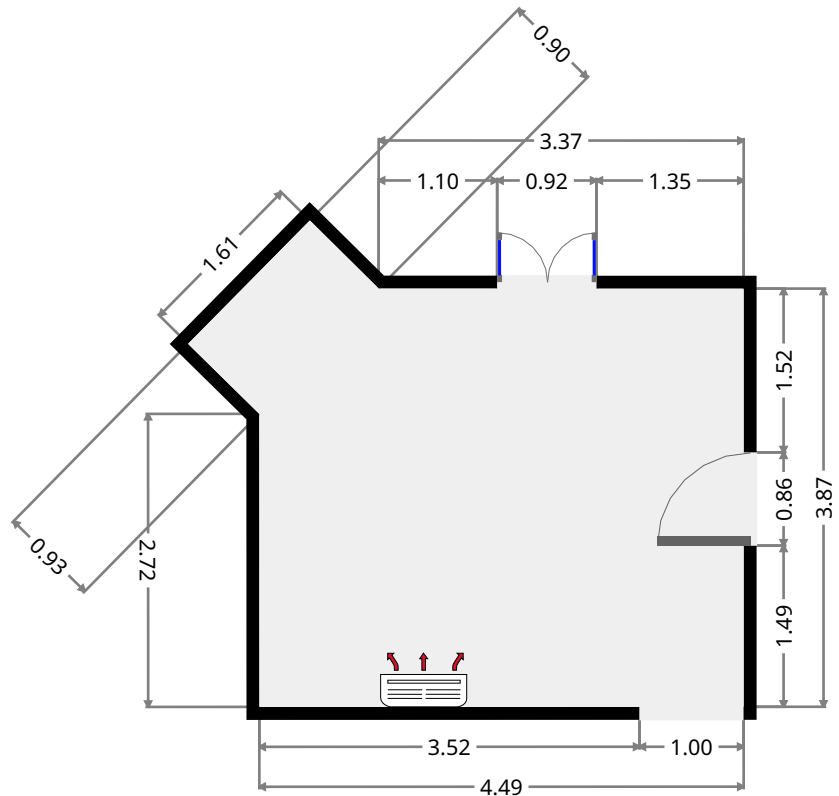
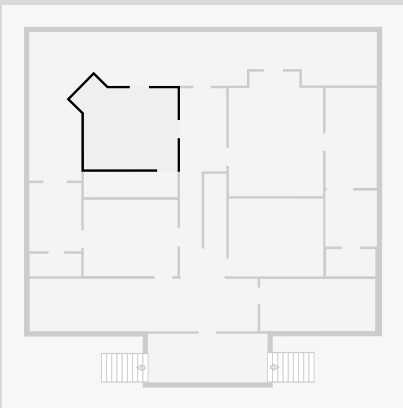

THIS FLOORPLAN IS PROVIDED WITHOUT WARRANTY OF ANY KIND. SENSOPIA DISCLAIMS ANY WARRANTY INCLUDING, WITHOUT LIMITATION, SATISFACTORY QUALITY OR ACCURACY OF DIMENSIONS.

# 3 Athelstane Street

## WIR

Width: 1.20 m  
 Length: 4.49 m  
 Area: 5.42 m<sup>2</sup>  
 Perimeter: 11.40 m

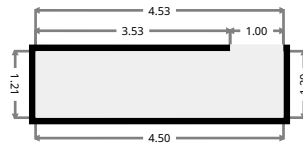
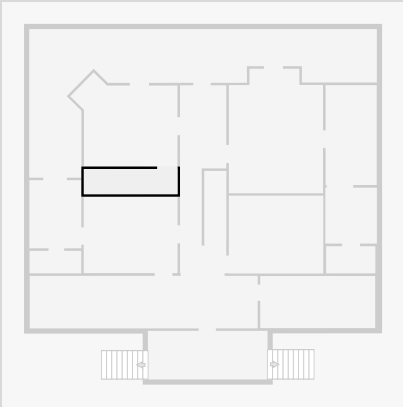

## Verandah

Width: 7.13 m  
 Length: 16.68 m  
 Area: 51.29 m<sup>2</sup>  
 Perimeter: 50.36 m

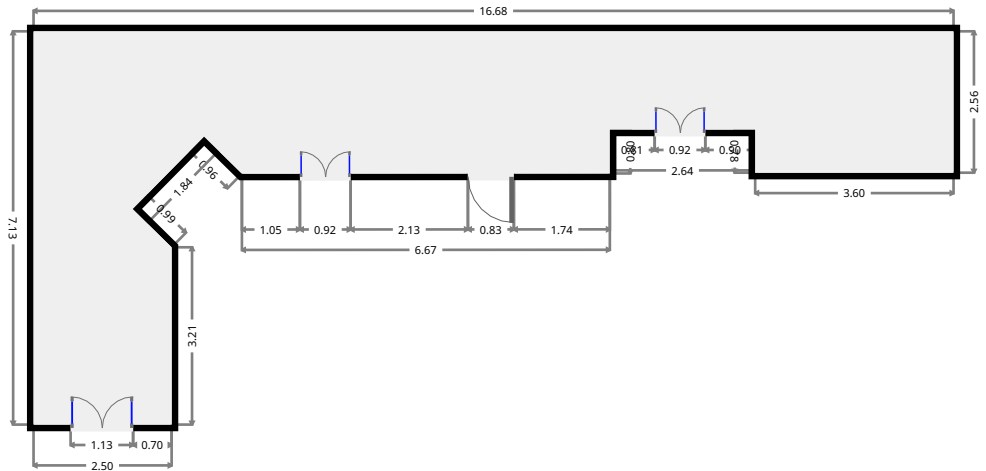
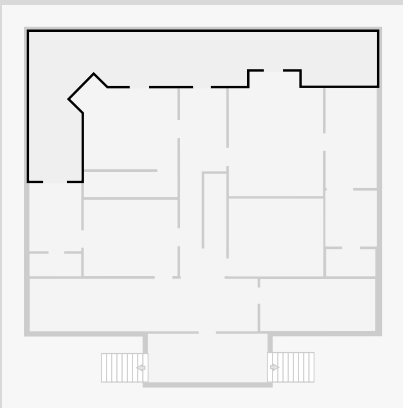

THIS FLOORPLAN IS PROVIDED WITHOUT WARRANTY OF ANY KIND. SENSOPIA DISCLAIMS ANY WARRANTY INCLUDING, WITHOUT LIMITATION, SATISFACTORY QUALITY OR ACCURACY OF DIMENSIONS.



# 3 Athelstane Street

## Front Verandah

Width: 2.33 m  
Length: 5.74 m  
Area: 13.39 m<sup>2</sup>  
Perimeter: 16.14 m

