

# 287 Alma Street

## Ground Floor

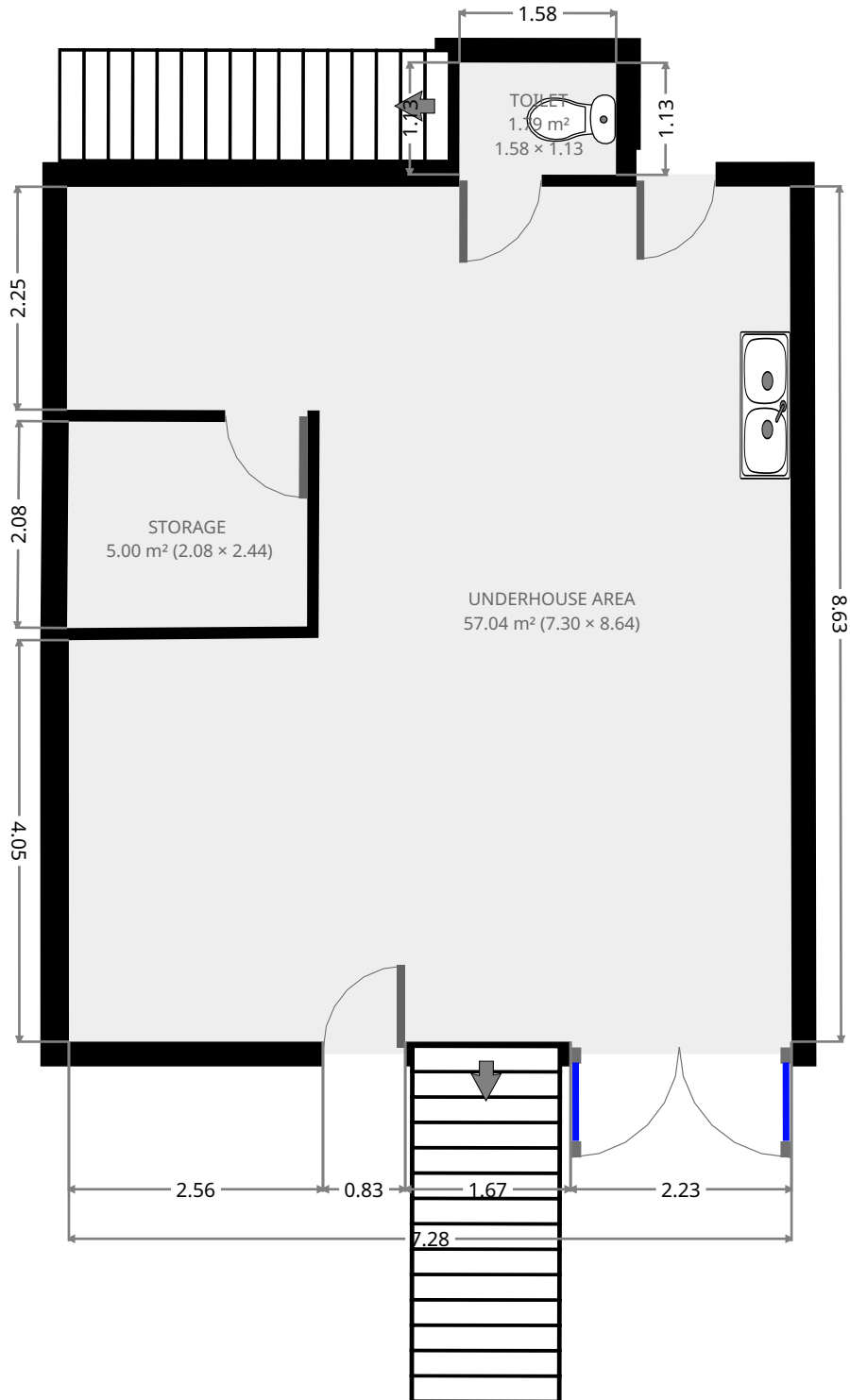

THIS FLOORPLAN IS PROVIDED WITHOUT WARRANTY OF ANY KIND. SENSOPIA DISCLAIMS ANY WARRANTY INCLUDING, WITHOUT LIMITATION, SATISFACTORY QUALITY OR ACCURACY OF DIMENSIONS.



# 287 Alma Street

## Underhouse Area

Width: 7.30 m  
 Length: 8.64 m  
 Area: 57.04 m<sup>2</sup>  
 Perimeter: 36.88 m

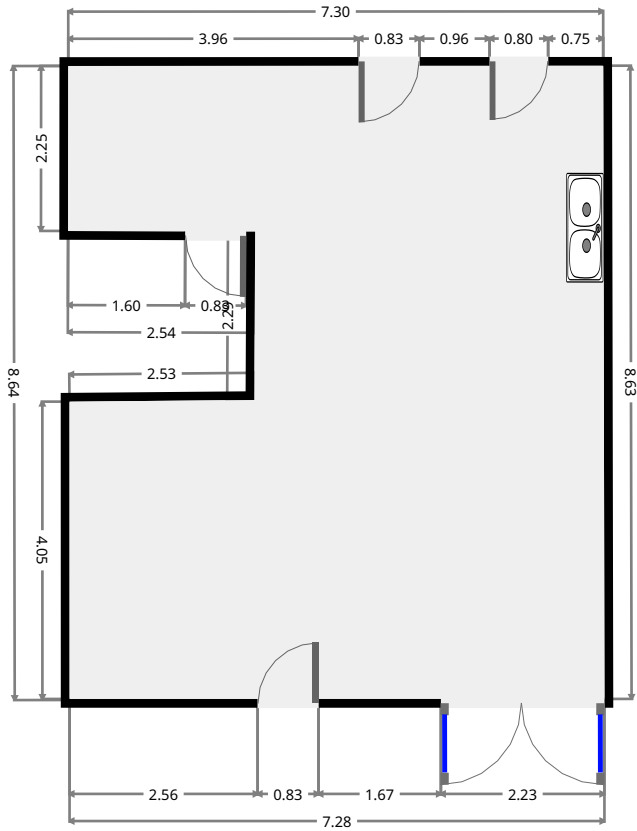
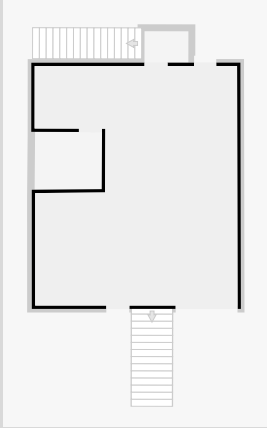

## Storage

Width: 2.08 m  
 Length: 2.44 m  
 Area: 5.00 m<sup>2</sup>  
 Perimeter: 8.97 m

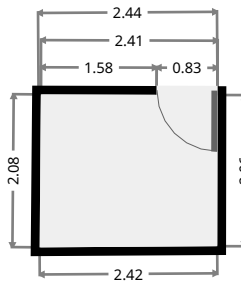
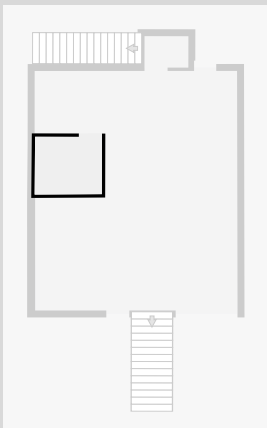

# 287 Alma Street

## Toilet

Width: 1.13 m  
Length: 1.58 m  
Area: 1.79 m<sup>2</sup>  
Perimeter: 5.42 m

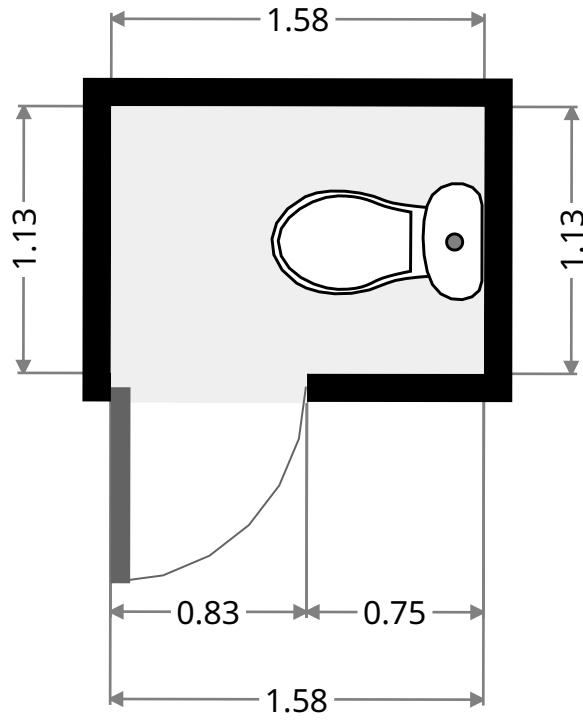
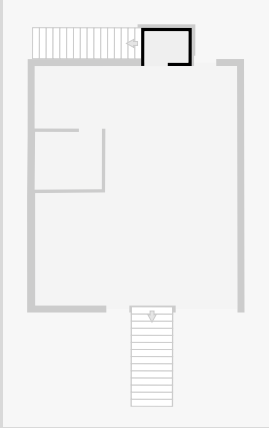

# 287 Alma Street

## 1st Floor

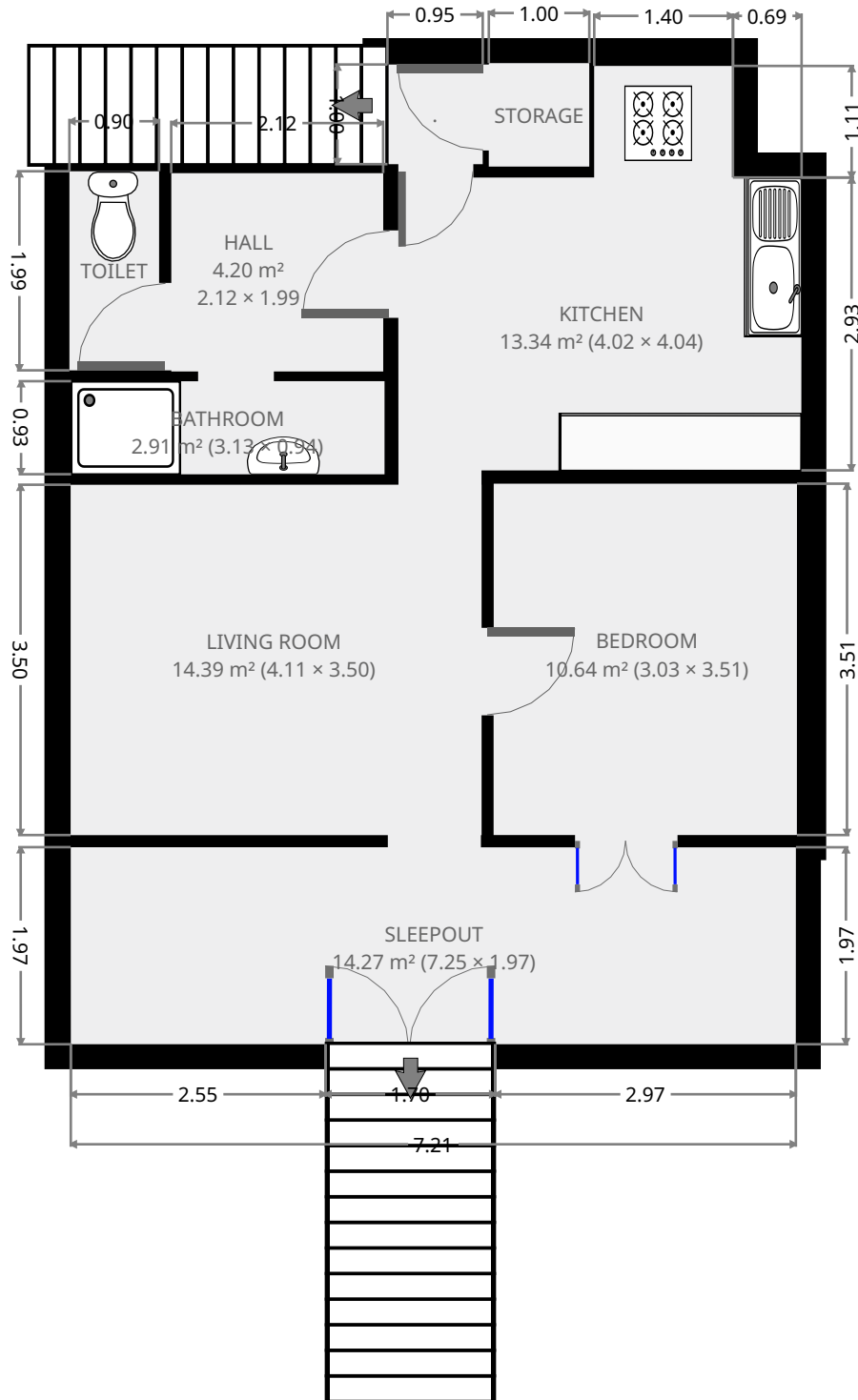

THIS FLOORPLAN IS PROVIDED WITHOUT WARRANTY OF ANY KIND. SENSOPIA DISCLAIMS ANY WARRANTY INCLUDING, WITHOUT LIMITATION, SATISFACTORY QUALITY OR ACCURACY OF DIMENSIONS.



# 287 Alma Street

## Sleepout

Width: 1.97 m  
 Length: 7.25 m  
 Area: 14.27 m<sup>2</sup>  
 Perimeter: 18.43 m

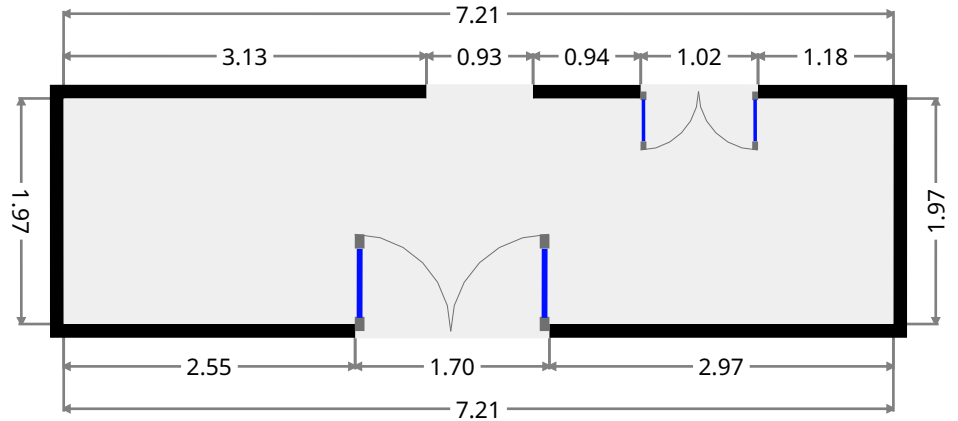
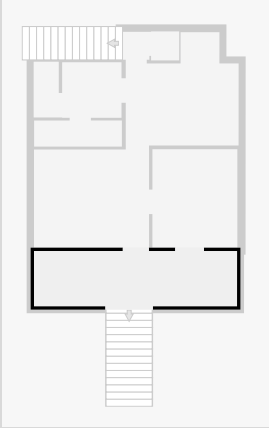

## Living Room

Width: 3.50 m  
 Length: 4.11 m  
 Area: 14.39 m<sup>2</sup>  
 Perimeter: 15.22 m

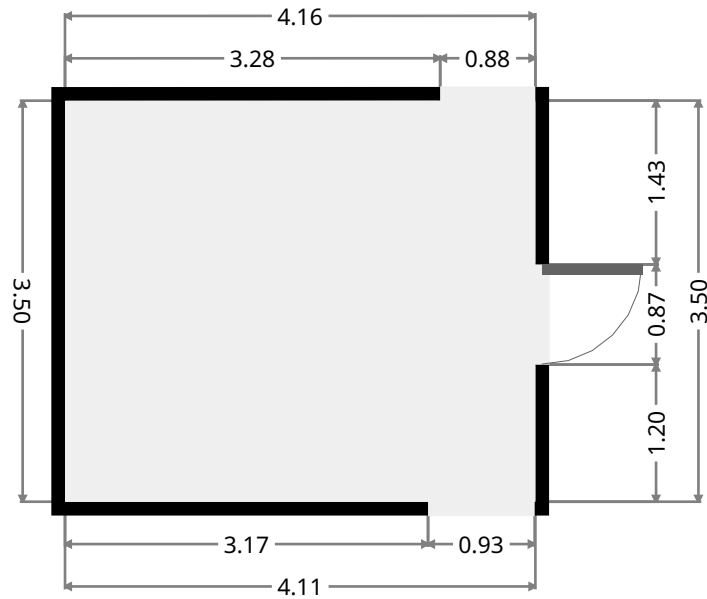
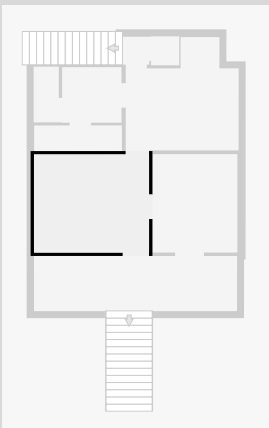

# 287 Alma Street

## Bedroom

Width: 3.03 m  
 Length: 3.51 m  
 Area: 10.64 m<sup>2</sup>  
 Perimeter: 13.09 m

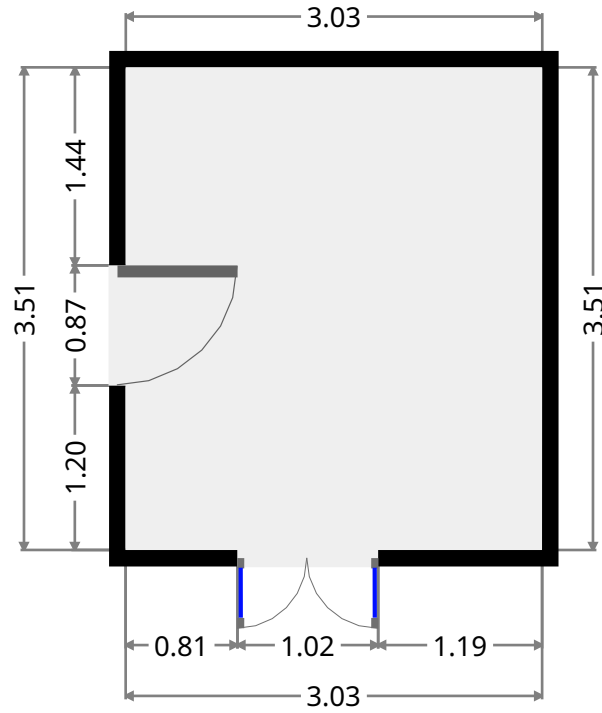
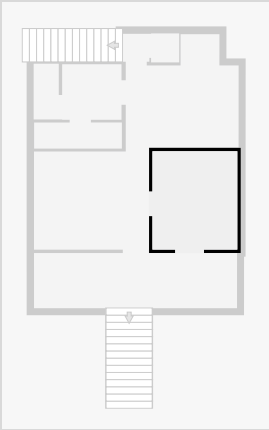

## Kitchen

Width: 4.02 m  
 Length: 4.04 m  
 Area: 13.34 m<sup>2</sup>  
 Perimeter: 16.14 m

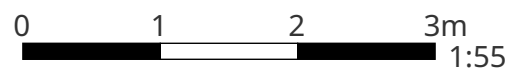
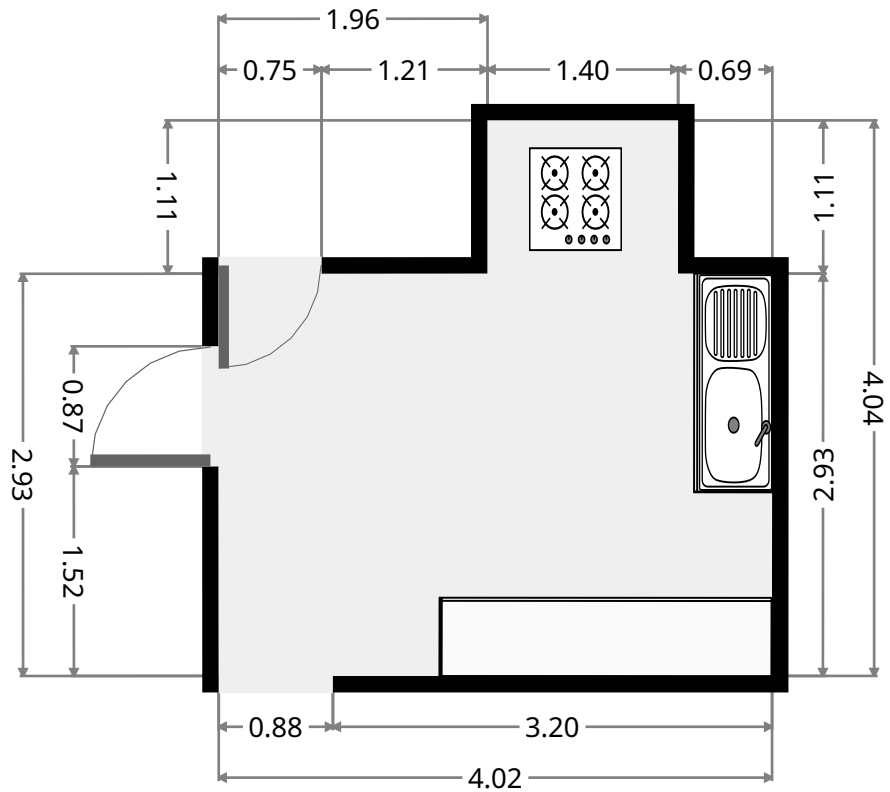
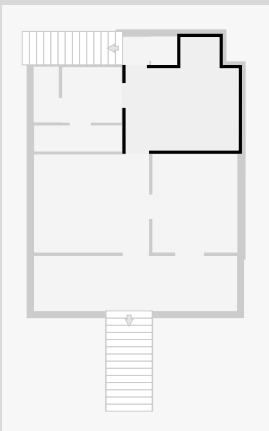

THIS FLOORPLAN IS PROVIDED WITHOUT WARRANTY OF ANY KIND. SENSOPIA DISCLAIMS ANY WARRANTY INCLUDING, WITHOUT LIMITATION, SATISFACTORY QUALITY OR ACCURACY OF DIMENSIONS.

# 287 Alma Street

## Hall

Width: 1.99 m  
 Length: 2.12 m  
 Area: 4.20 m<sup>2</sup>  
 Perimeter: 8.20 m

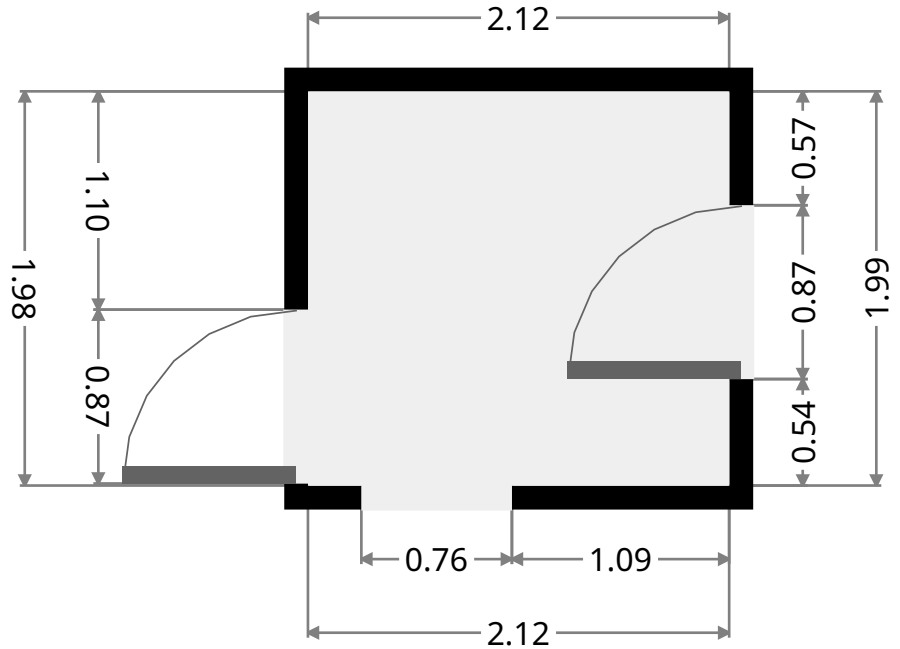
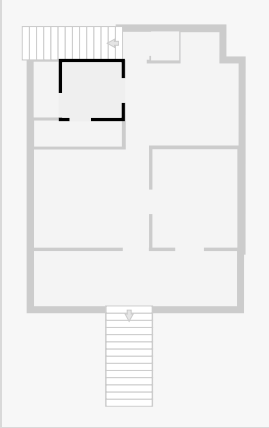

## Bathroom

Width: 0.94 m  
 Length: 3.13 m  
 Area: 2.91 m<sup>2</sup>  
 Perimeter: 8.13 m

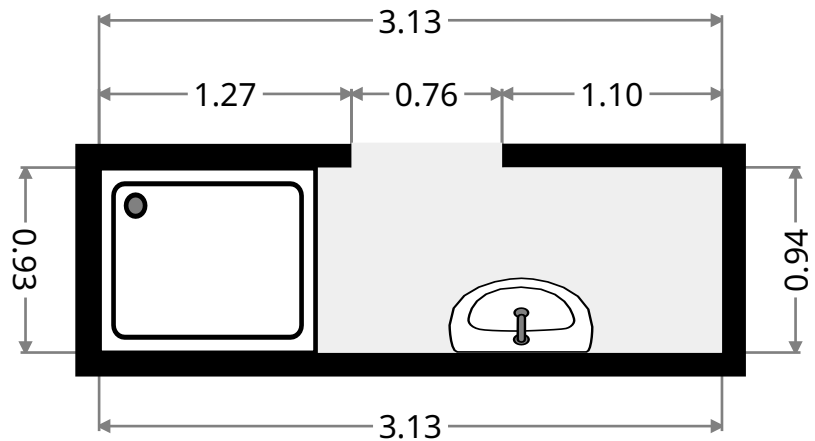
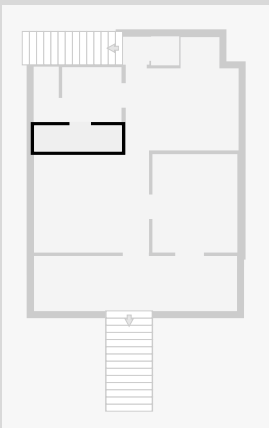

# 287 Alma Street

## Toilet

Width: 0.90 m  
Length: 2.00 m  
Area: 1.78 m<sup>2</sup>  
Perimeter: 5.77 m

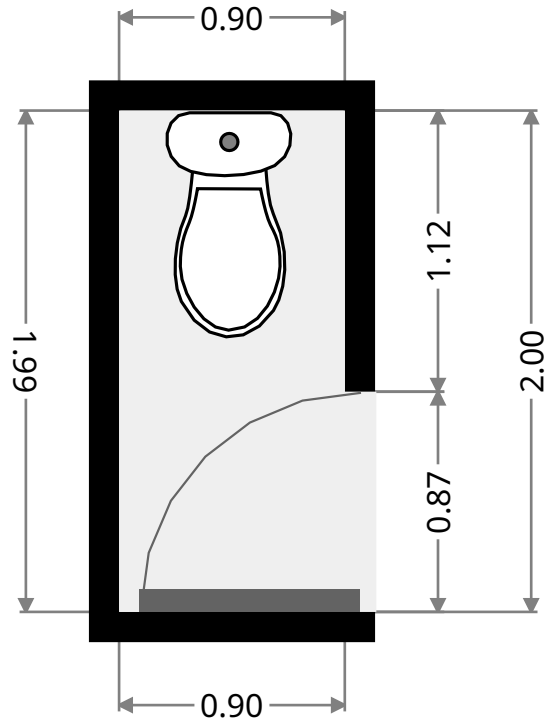
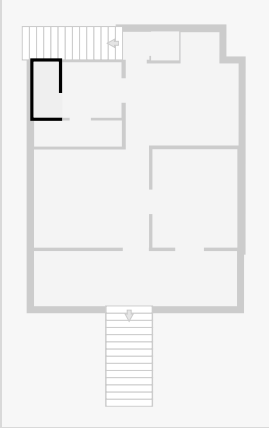

## Storage

Width: 1.00 m  
Length: 1.04 m  
Area: 1.04 m<sup>2</sup>  
Perimeter: 4.08 m

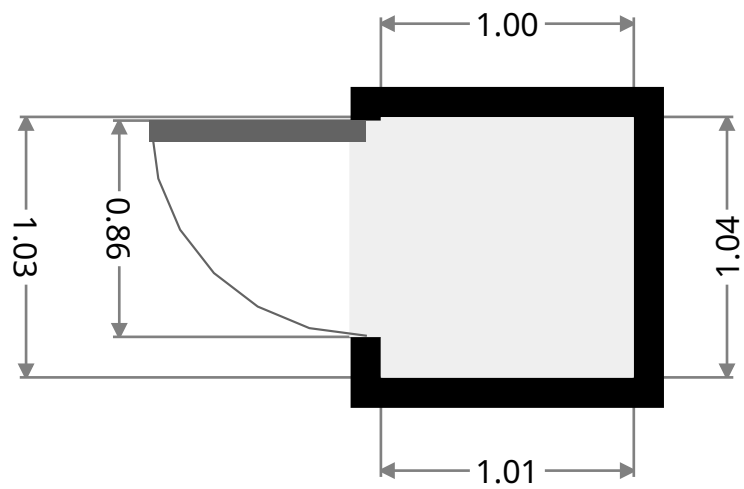
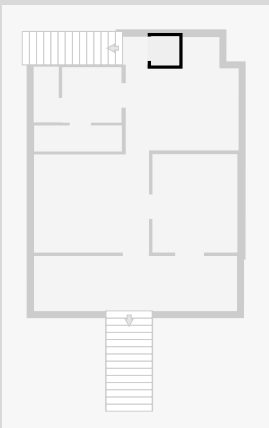



# 287 Alma Street

•  
Width: 0.95 m  
Length: 1.00 m  
Area: 0.95 m<sup>2</sup>  
Perimeter: 3.90 m

