

23 Johnson Road

Ground Floor

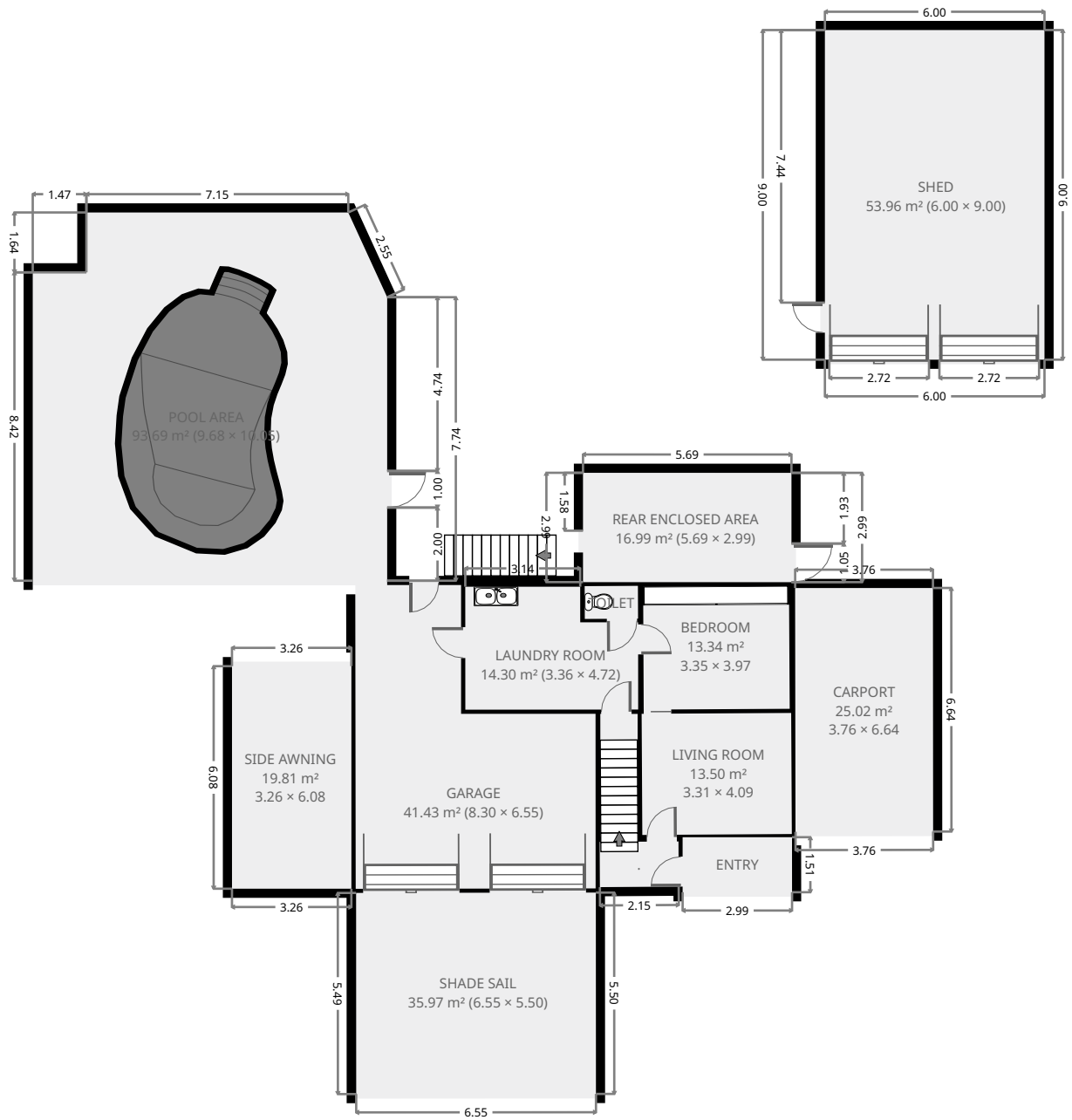

THIS FLOORPLAN IS PROVIDED WITHOUT WARRANTY OF ANY KIND. SENSOPIA DISCLAIMS ANY WARRANTY INCLUDING, WITHOUT LIMITATION, SATISFACTORY QUALITY OR ACCURACY OF DIMENSIONS.



23 Johnson Road

•
 Width: 1.24 m
 Length: 2.15 m
 Area: 2.66 m²
 Perimeter: 6.77 m

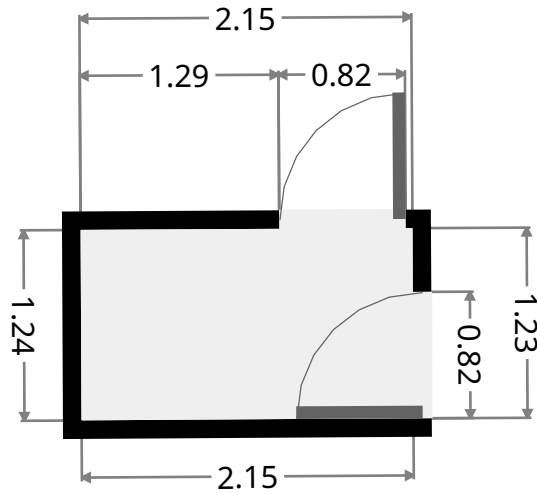

Living Room

Width: 3.31 m
 Length: 4.09 m
 Area: 13.50 m²
 Perimeter: 14.78 m

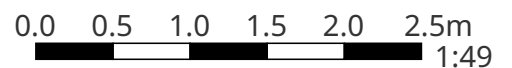
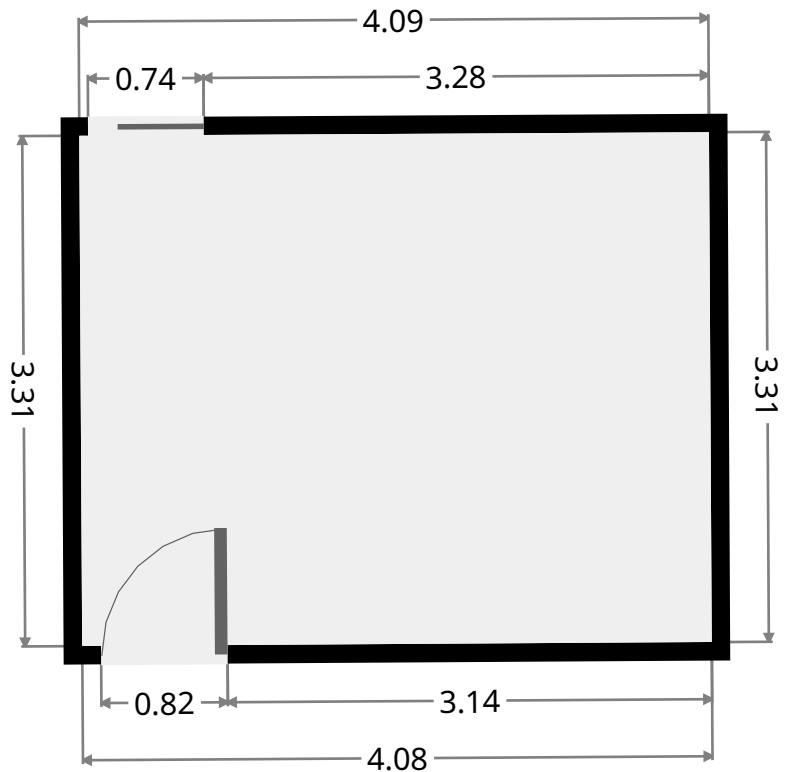

THIS FLOORPLAN IS PROVIDED WITHOUT WARRANTY OF ANY KIND. SENSOPIA DISCLAIMS ANY WARRANTY INCLUDING, WITHOUT LIMITATION, SATISFACTORY QUALITY OR ACCURACY OF DIMENSIONS.

23 Johnson Road

Bedroom

Width: 3.35 m
 Length: 3.97 m
 Area: 13.34 m²
 Perimeter: 14.66 m

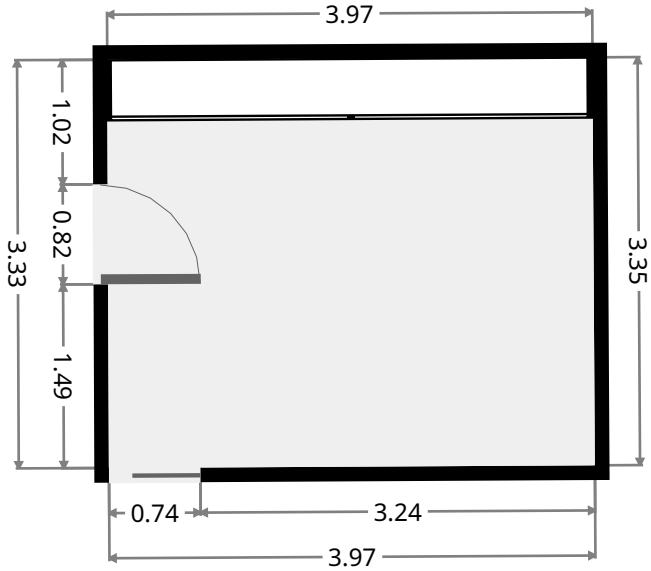

Laundry Room

Width: 3.36 m
 Length: 4.72 m
 Area: 14.30 m²
 Perimeter: 16.15 m

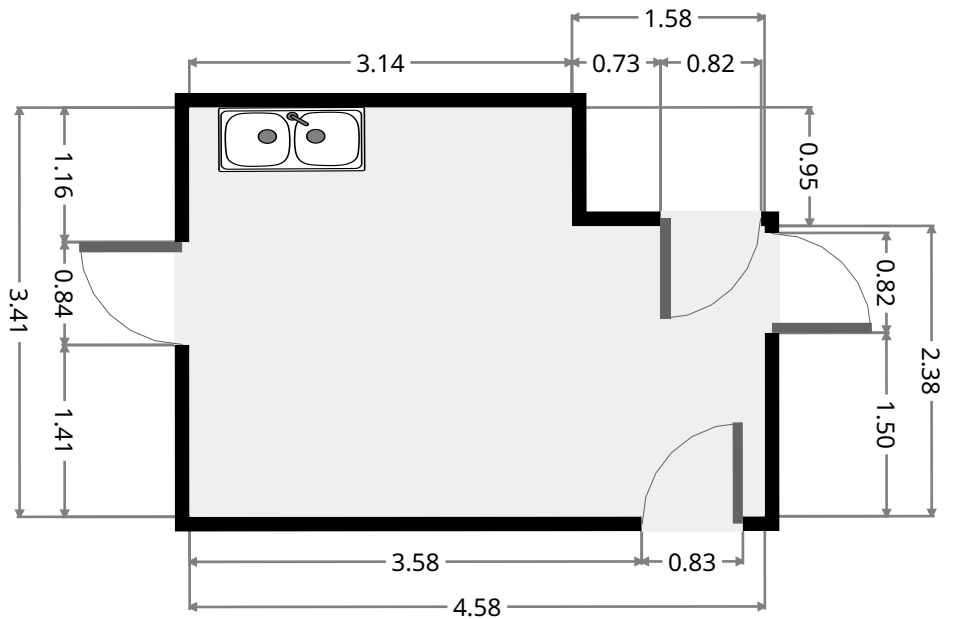
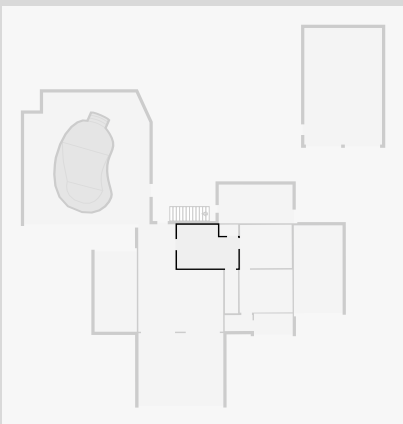

23 Johnson Road

Toilet

Width: 0.90 m
Length: 1.46 m
Area: 1.30 m²
Perimeter: 4.70 m

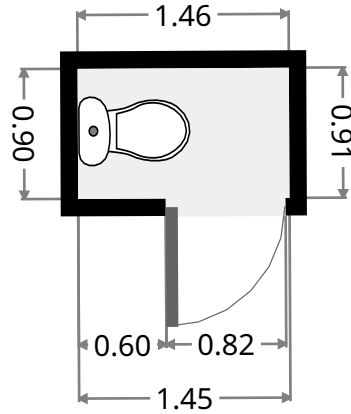

Stairway

Width: 1.01 m
Length: 3.35 m
Area: 3.41 m²
Perimeter: 8.74 m

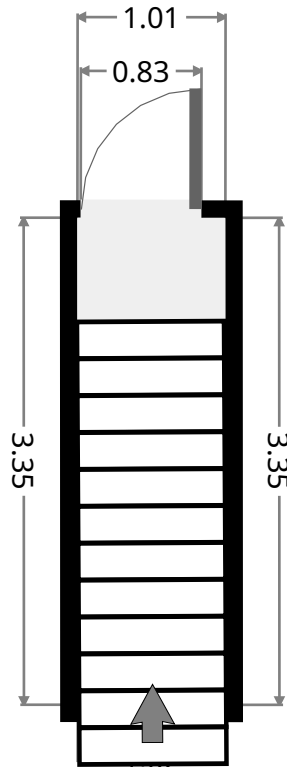

23 Johnson Road

Garage

Width: 6.55 m
 Length: 8.30 m
 Area: 41.43 m²
 Perimeter: 29.69 m

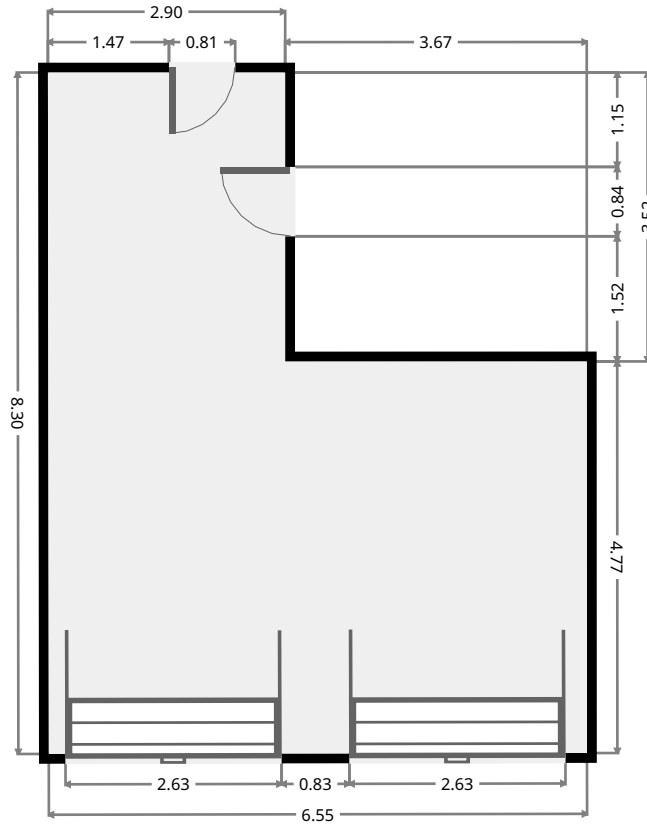

Rear Enclosed Area

Width: 2.99 m
 Length: 5.69 m
 Area: 16.99 m²
 Perimeter: 17.35 m

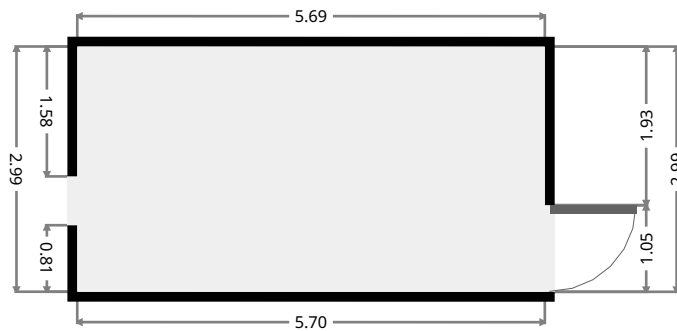

23 Johnson Road

Shed

Width: 6.00 m
Length: 9.00 m
Area: 53.96 m²
Perimeter: 29.99 m

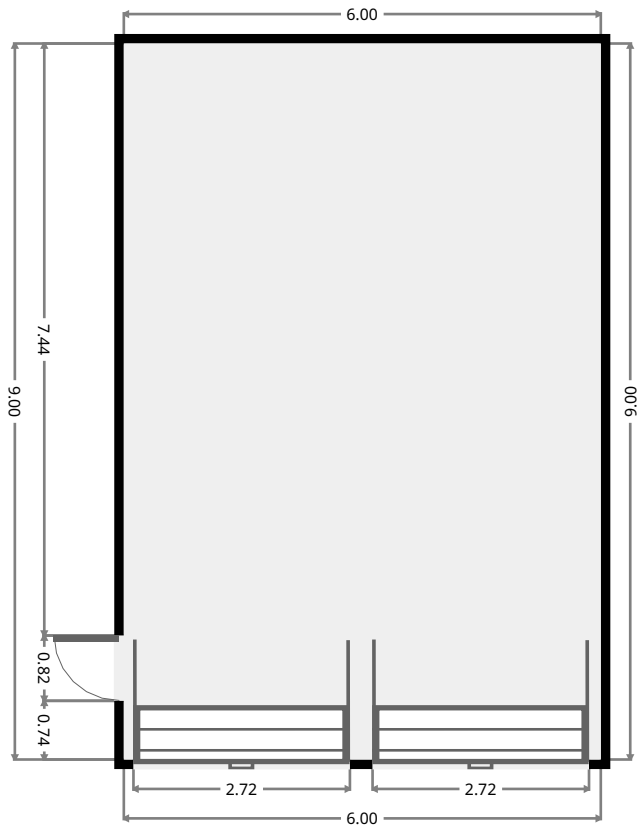

Carport

Width: 3.76 m
Length: 6.64 m
Area: 25.02 m²
Perimeter: 20.83 m

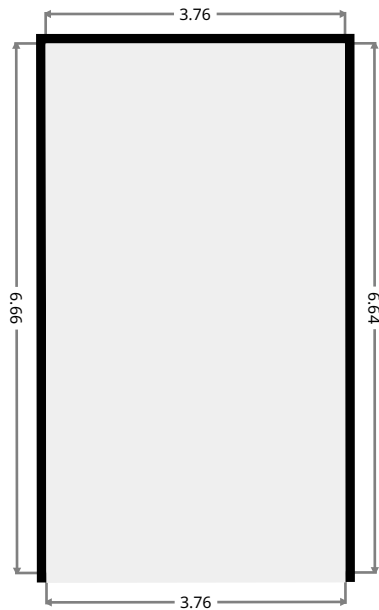

23 Johnson Road

Side Awning

Width: 3.26 m
 Length: 6.08 m
 Area: 19.81 m²
 Perimeter: 18.67 m

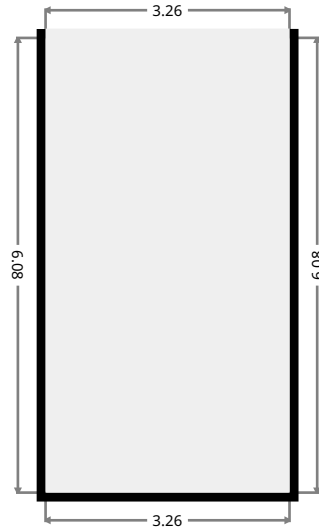

Pool Area

Width: 9.68 m
 Length: 10.05 m
 Area: 93.69 m²
 Perimeter: 38.64 m

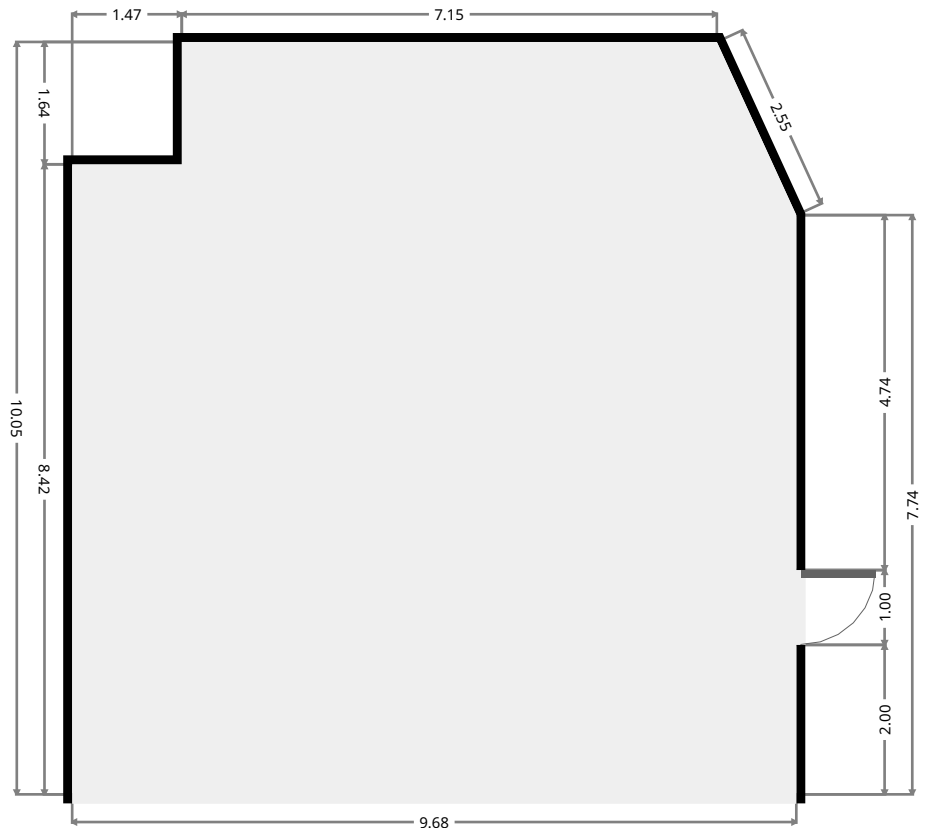
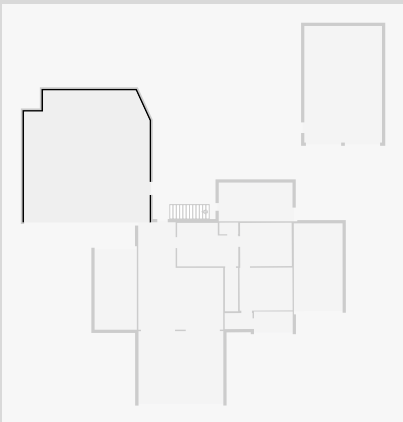

THIS FLOORPLAN IS PROVIDED WITHOUT WARRANTY OF ANY KIND. SENSOPIA DISCLAIMS ANY WARRANTY INCLUDING, WITHOUT LIMITATION, SATISFACTORY QUALITY OR ACCURACY OF DIMENSIONS.

23 Johnson Road

Entry

Width: 1.51 m
Length: 2.99 m
Area: 4.48 m²
Perimeter: 8.98 m

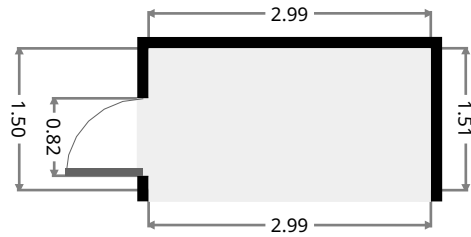

Shade Sail

Width: 5.50 m
Length: 6.55 m
Area: 35.97 m²
Perimeter: 24.08 m

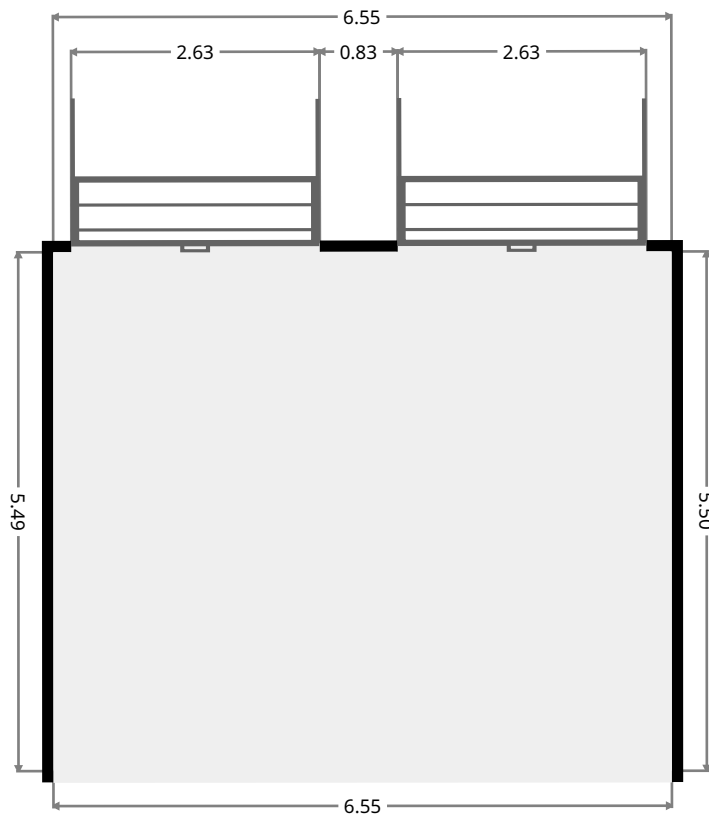

23 Johnson Road

1st Floor



THIS FLOORPLAN IS PROVIDED WITHOUT WARRANTY OF ANY KIND. SENSOPIA DISCLAIMS ANY WARRANTY INCLUDING, WITHOUT LIMITATION, SATISFACTORY QUALITY OR ACCURACY OF DIMENSIONS.



23 Johnson Road

Living Room

Width: 3.96 m
 Length: 5.38 m
 Area: 21.28 m²
 Perimeter: 18.67 m

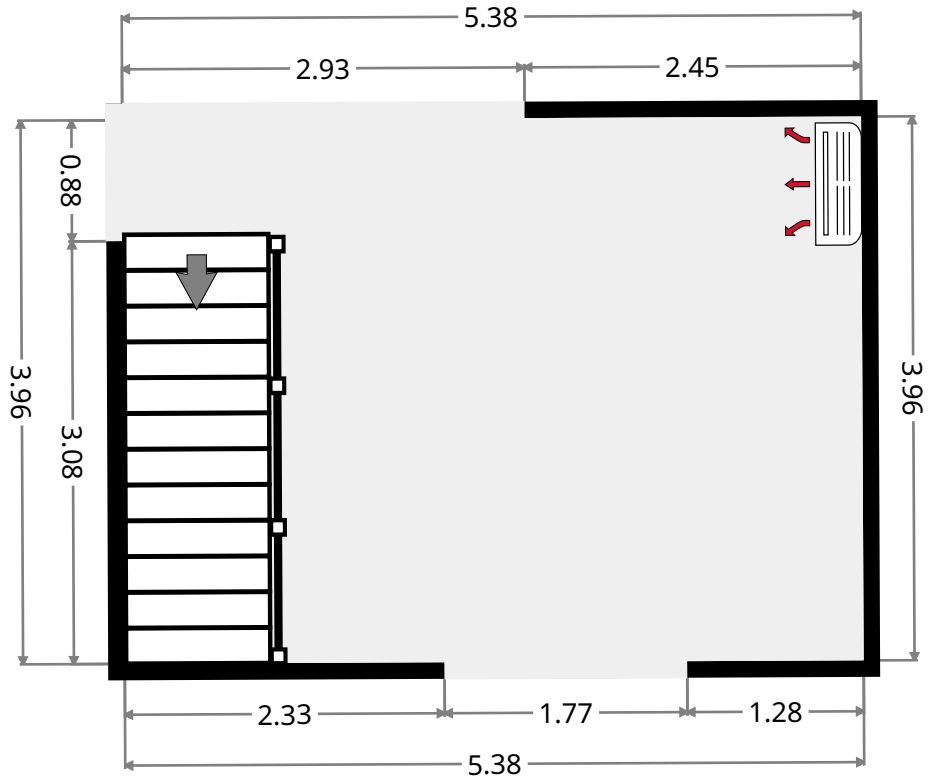
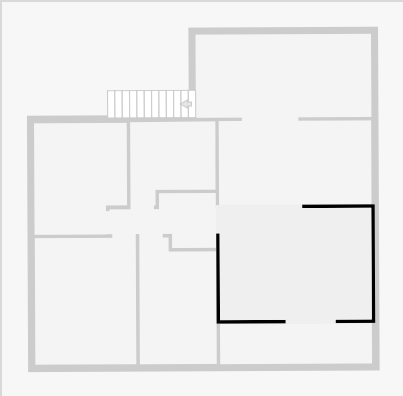

Sunroom

Width: 1.43 m
 Length: 5.38 m
 Area: 7.69 m²
 Perimeter: 13.62 m

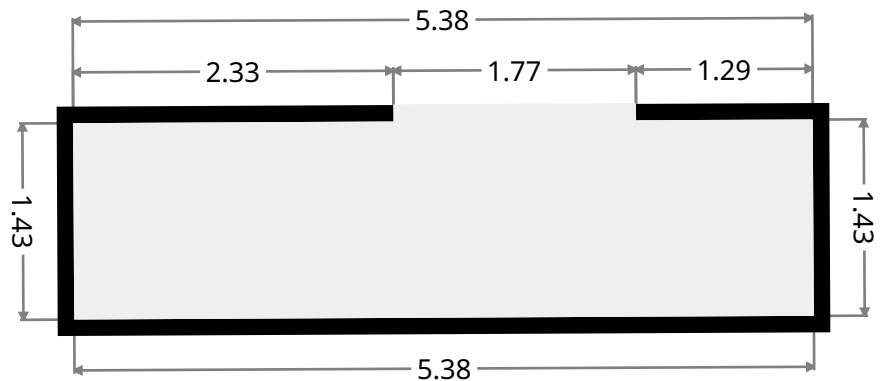
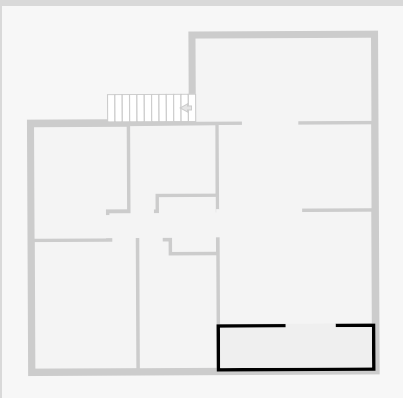

23 Johnson Road

Kitchen/Dining

Width: 2.98 m
Length: 5.40 m
Area: 16.07 m²
Perimeter: 16.76 m

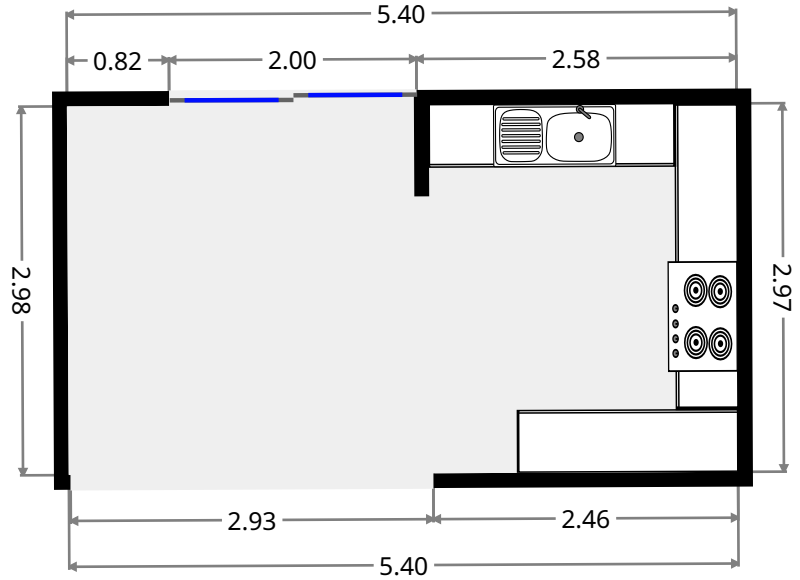
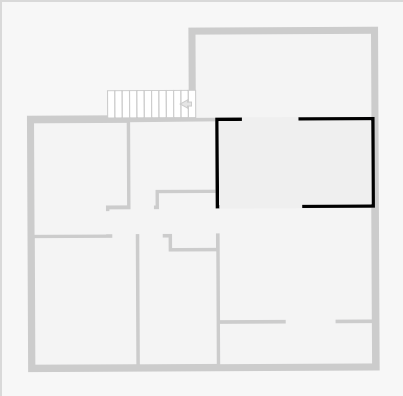

Rear Verandah

Width: 2.95 m
Length: 6.22 m
Area: 18.34 m²
Perimeter: 18.34 m

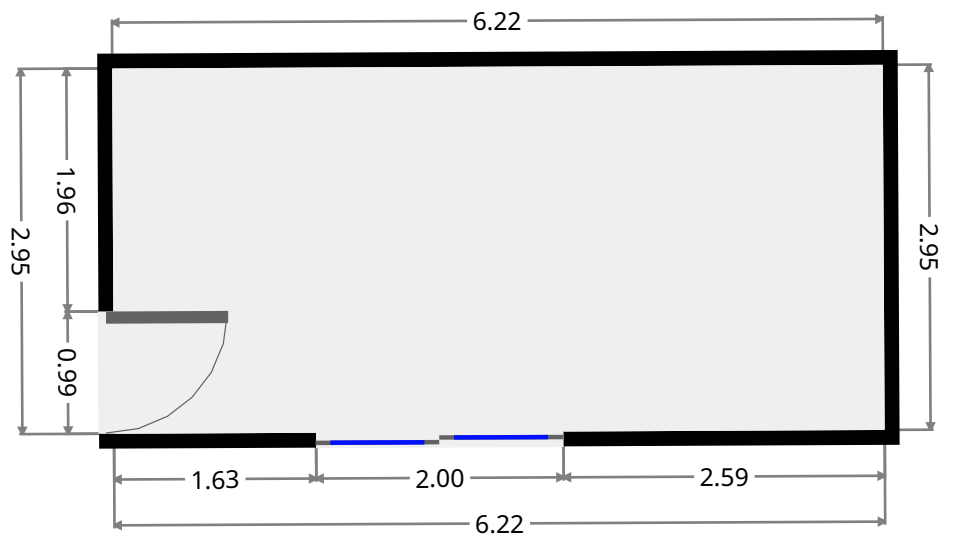
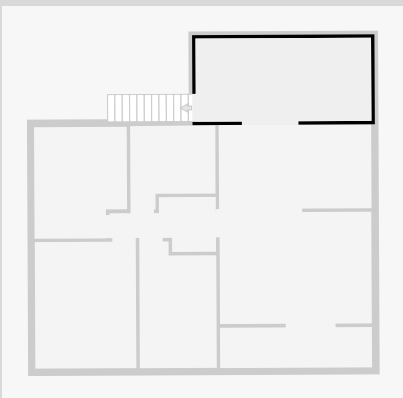

23 Johnson Road

Hall

Width: 1.95 m
 Length: 3.77 m
 Area: 5.23 m²
 Perimeter: 11.43 m

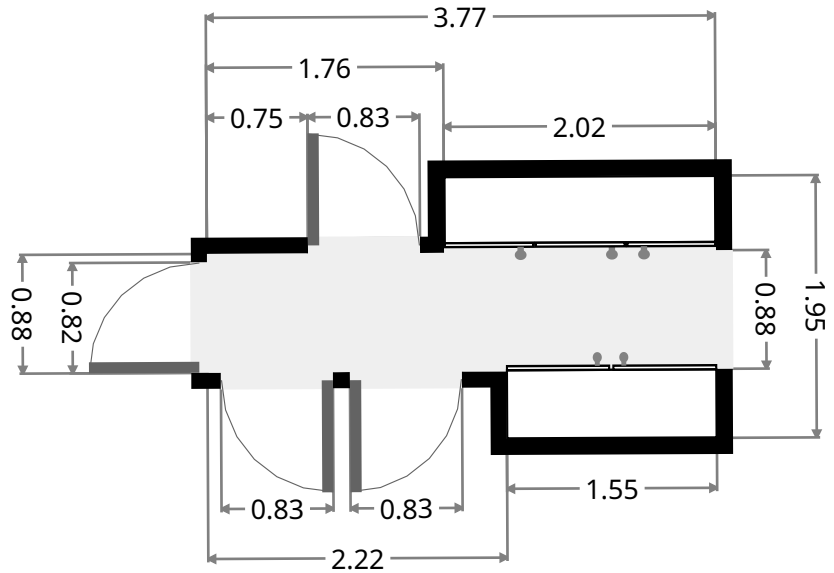
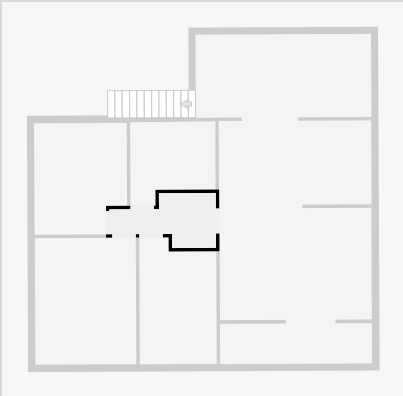

Bedroom

Width: 2.73 m
 Length: 4.49 m
 Area: 11.39 m²
 Perimeter: 14.42 m

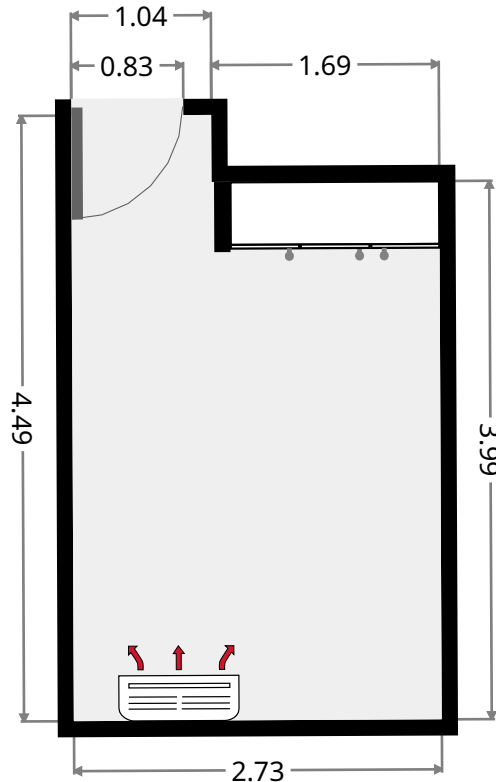
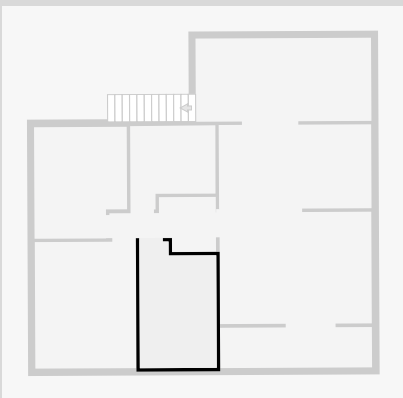

THIS FLOORPLAN IS PROVIDED WITHOUT WARRANTY OF ANY KIND. SENSOPIA DISCLAIMS ANY WARRANTY INCLUDING, WITHOUT LIMITATION, SATISFACTORY QUALITY OR ACCURACY OF DIMENSIONS.

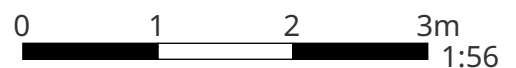

23 Johnson Road

Master Bedroom

Width: 3.58 m
Length: 4.48 m
Area: 16.05 m²
Perimeter: 16.13 m

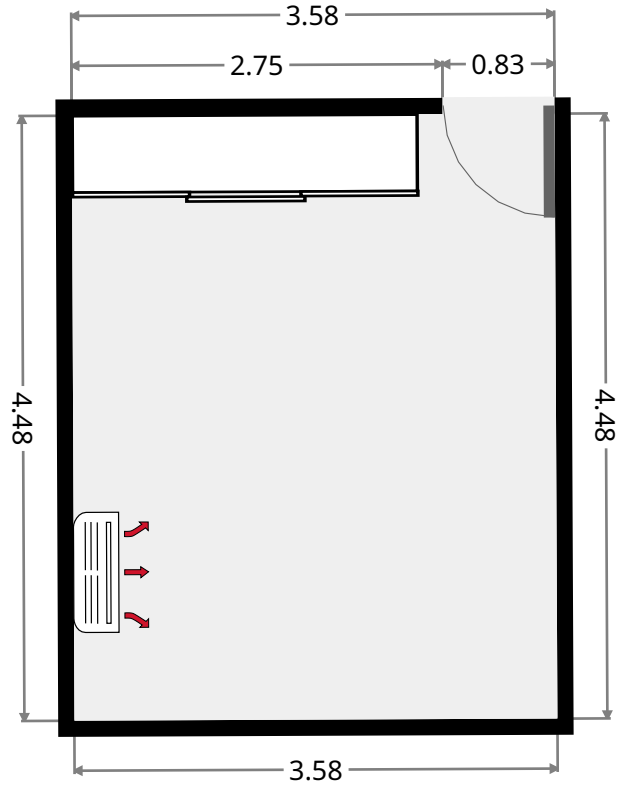
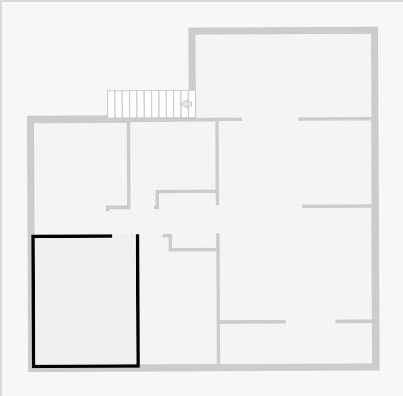

Bedroom

Width: 3.29 m
Length: 3.95 m
Area: 12.21 m²
Perimeter: 14.48 m

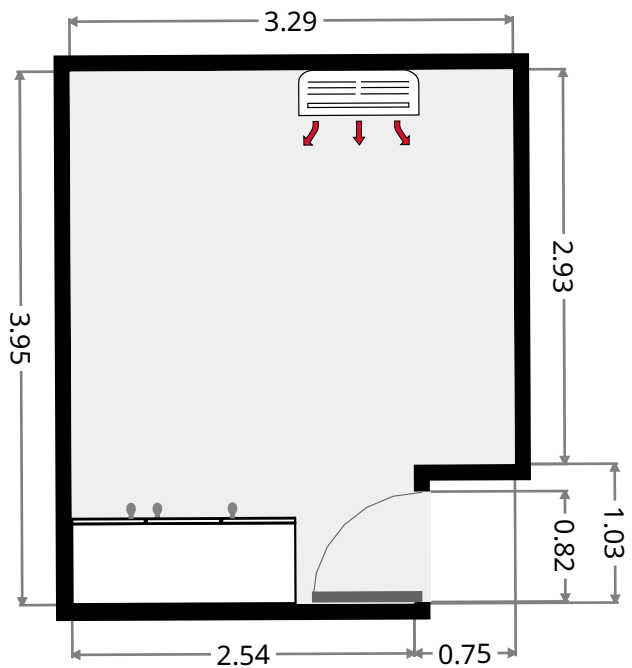
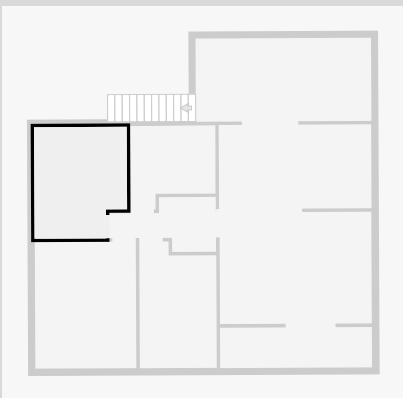

23 Johnson Road

Bathroom

Width: 2.96 m
Length: 3.04 m
Area: 7.77 m²
Perimeter: 11.97 m

