

Ground Floor

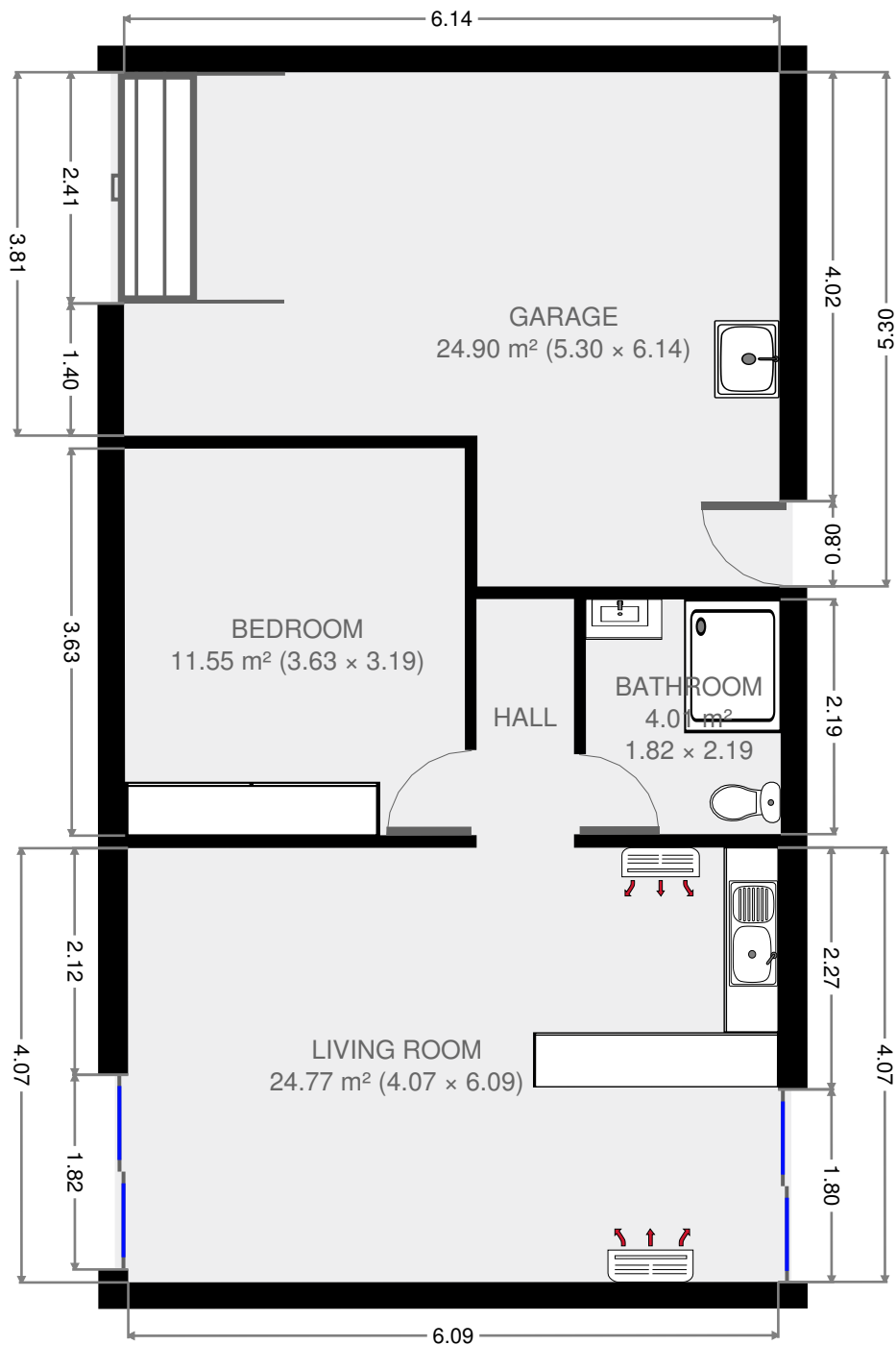

THIS FLOORPLAN IS PROVIDED WITHOUT WARRANTY OF ANY KIND. SENSOPIA DISCLAIMS ANY WARRANTY INCLUDING, WITHOUT LIMITATION, SATISFACTORY QUALITY OR ACCURACY OF DIMENSIONS.

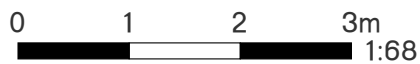

21 Barrett Street

Living Room

Width: 4.07 m
 Length: 6.09 m
 Area: 24.77 m²
 Perimeter: 20.32 m

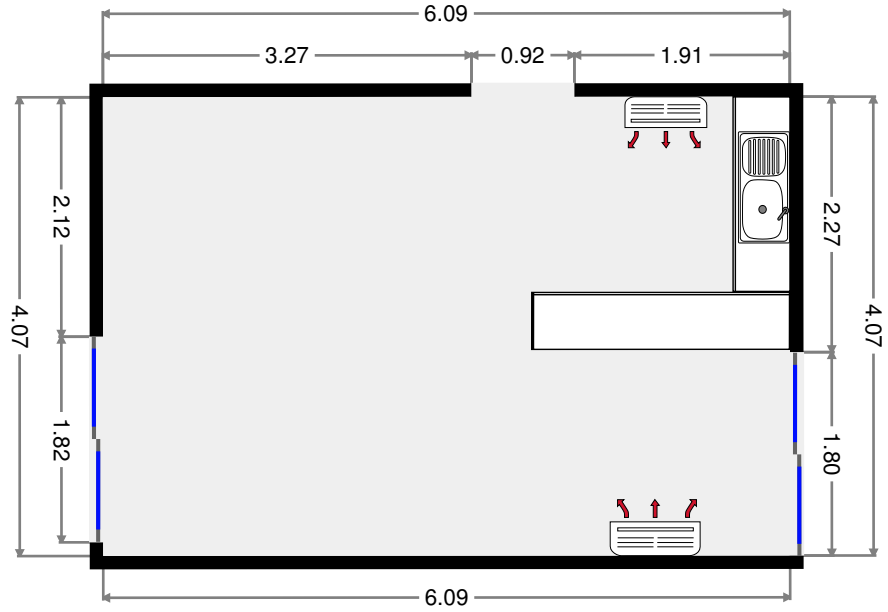
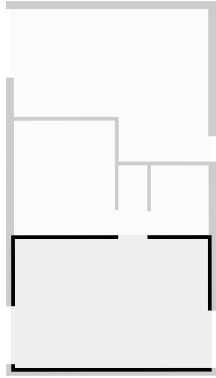

Hall

Width: 0.92 m
 Length: 2.21 m
 Area: 2.02 m²
 Perimeter: 6.25 m

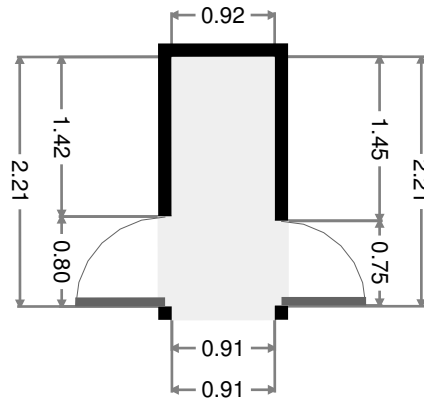
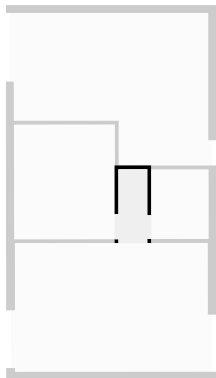

THIS FLOORPLAN IS PROVIDED WITHOUT WARRANTY OF ANY KIND. SENSOPIA DISCLAIMS ANY WARRANTY INCLUDING, WITHOUT LIMITATION, SATISFACTORY QUALITY OR ACCURACY OF DIMENSIONS.

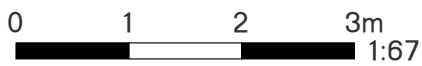

21 Barrett Street

2017-02-23

Bedroom

Width: 3.19 m
 Length: 3.63 m
 Area: 11.55 m²
 Perimeter: 13.62 m

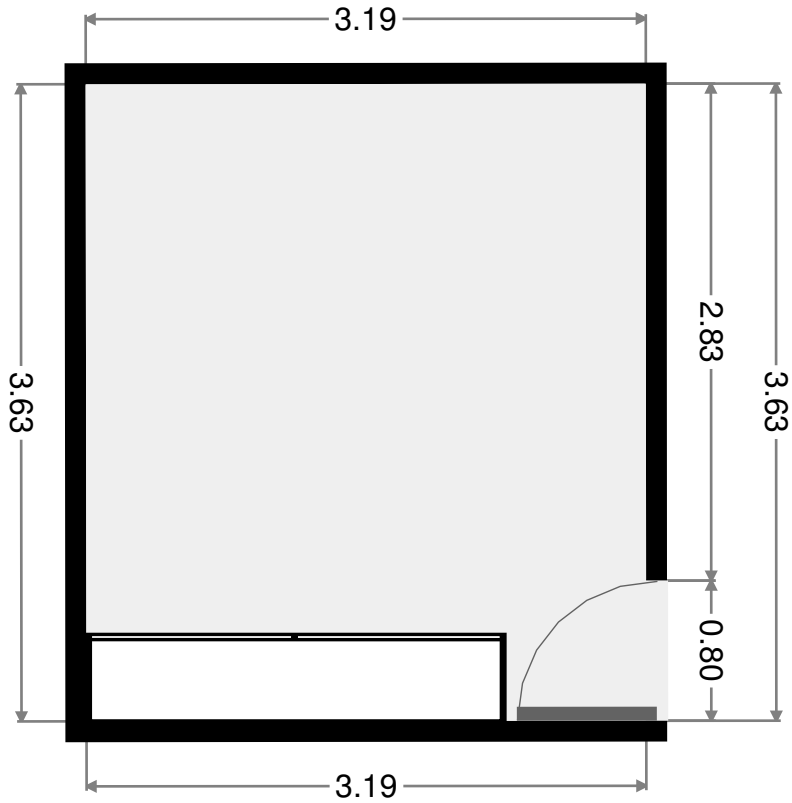
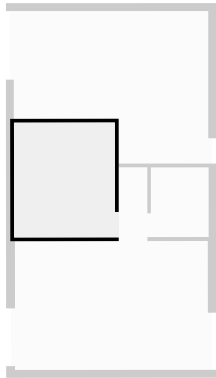

Bathroom

Width: 1.82 m
 Length: 2.19 m
 Area: 4.01 m²
 Perimeter: 8.05 m

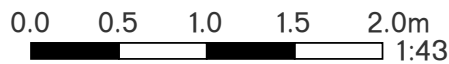
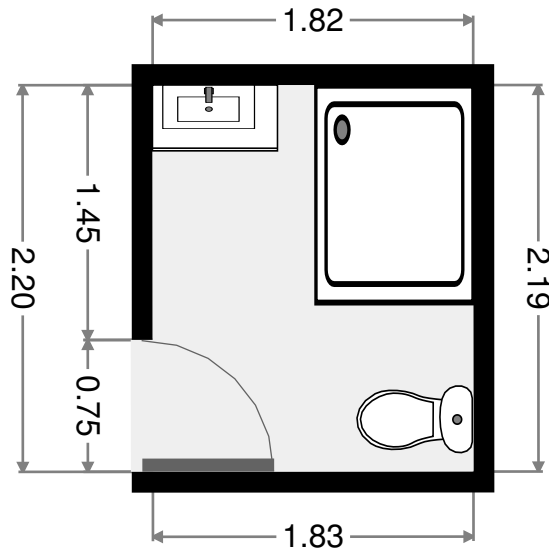
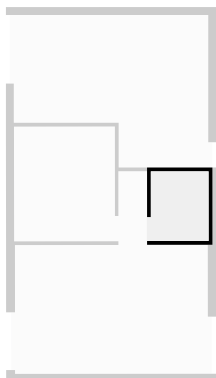

THIS FLOORPLAN IS PROVIDED WITHOUT WARRANTY OF ANY KIND. SENSOPIA DISCLAIMS ANY WARRANTY INCLUDING, WITHOUT LIMITATION, SATISFACTORY QUALITY OR ACCURACY OF DIMENSIONS.

Garage

Width: 5.30 m
Length: 6.14 m
Area: 24.90 m²
Perimeter: 21.91 m

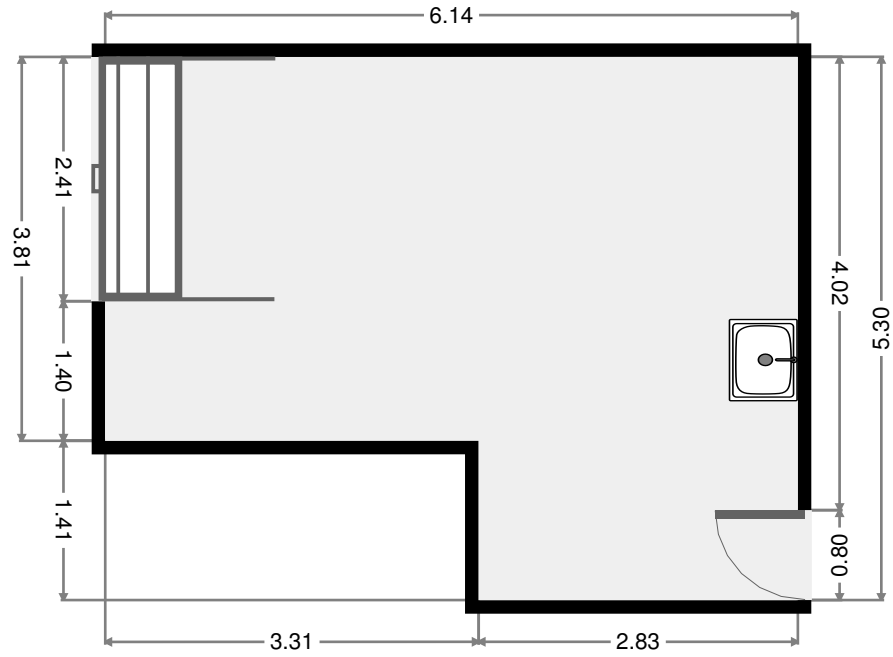
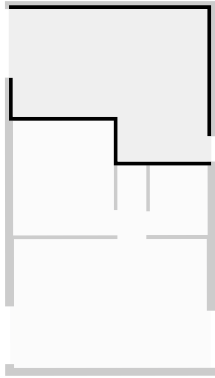

THIS FLOORPLAN IS PROVIDED WITHOUT WARRANTY OF ANY KIND. SENSOPIA DISCLAIMS ANY WARRANTY INCLUDING, WITHOUT LIMITATION, SATISFACTORY QUALITY OR ACCURACY OF DIMENSIONS.

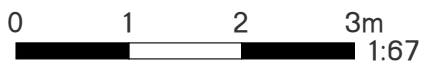

21 Barrett Street

2017-02-23

1st Floor

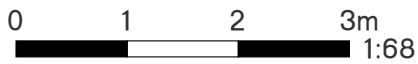
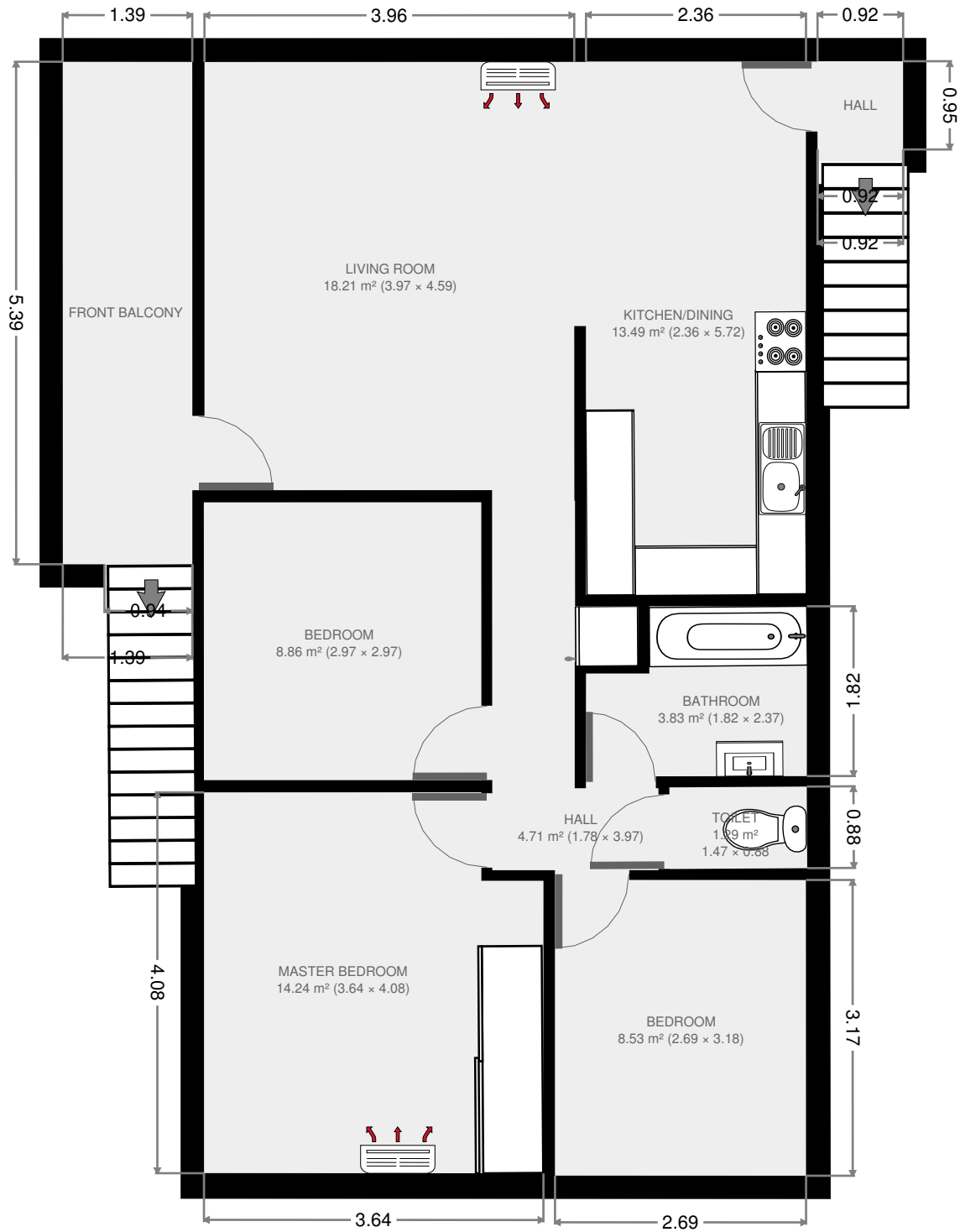

THIS FLOORPLAN IS PROVIDED WITHOUT WARRANTY OF ANY KIND. SENSOPRIA DISCLAIMS ANY WARRANTY INCLUDING, WITHOUT LIMITATION, SATISFACTORY QUALITY OR ACCURACY OF DIMENSIONS.

21 Barrett Street

Living Room

Width: 3.97 m
 Length: 4.59 m
 Area: 18.21 m²
 Perimeter: 17.11 m

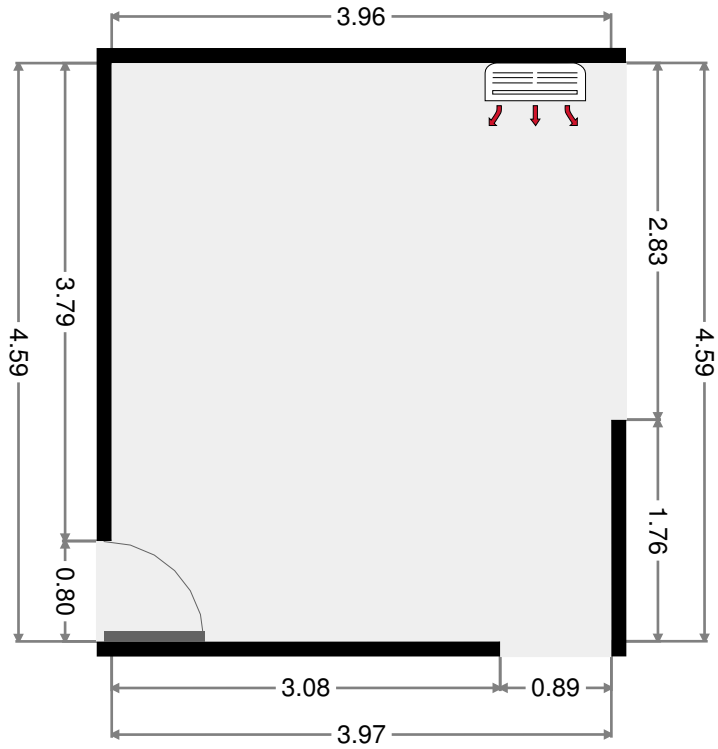
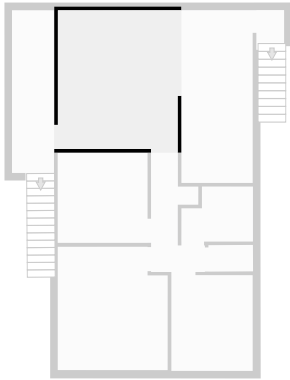

Kitchen/Dining

Width: 2.36 m
 Length: 5.72 m
 Area: 13.49 m²
 Perimeter: 16.16 m

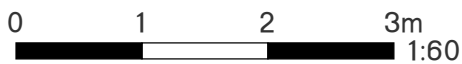
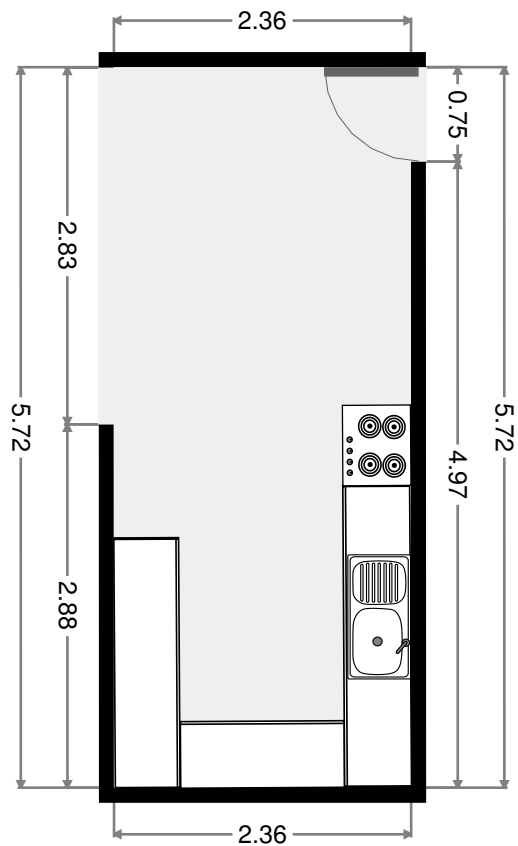
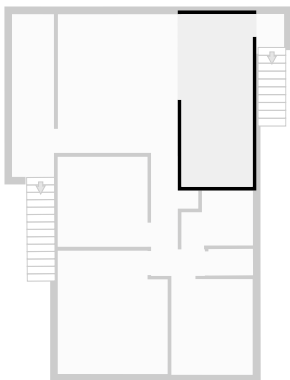

THIS FLOORPLAN IS PROVIDED WITHOUT WARRANTY OF ANY KIND. SENSOPIA DISCLAIMS ANY WARRANTY INCLUDING, WITHOUT LIMITATION, SATISFACTORY QUALITY OR ACCURACY OF DIMENSIONS.

Hall

Width: 1.78 m
 Length: 3.97 m
 Area: 4.71 m²
 Perimeter: 12.85 m

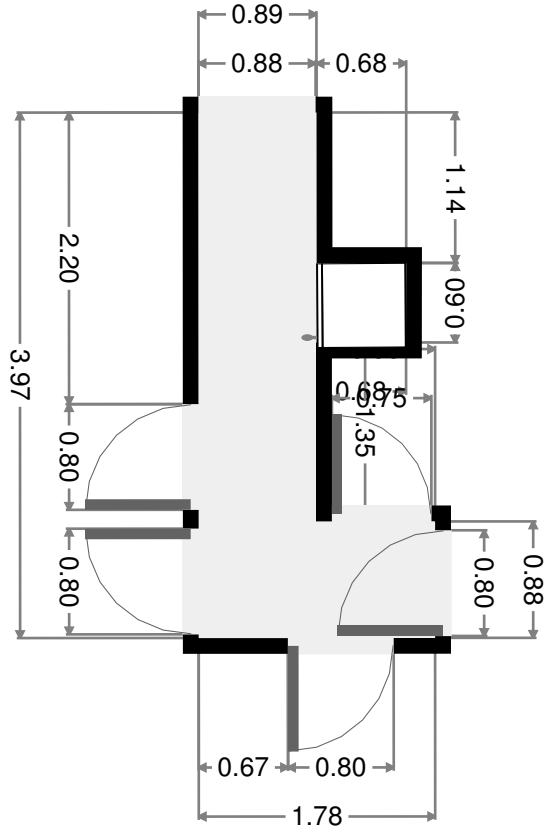
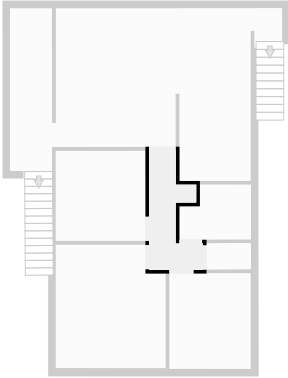

Bedroom

Width: 2.97 m
 Length: 2.97 m
 Area: 8.86 m²
 Perimeter: 11.91 m

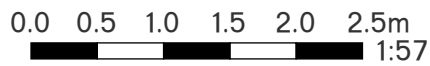
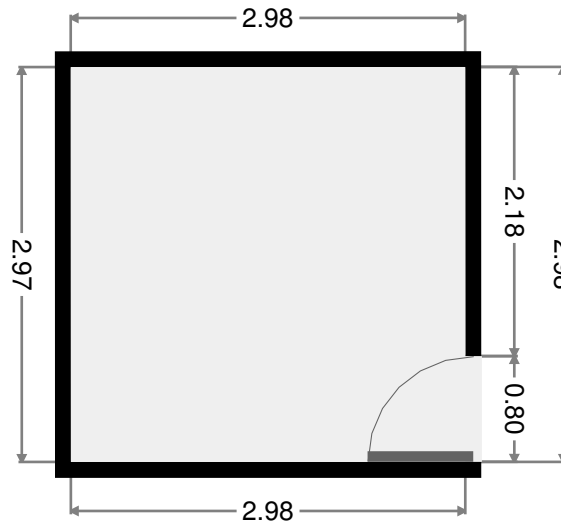
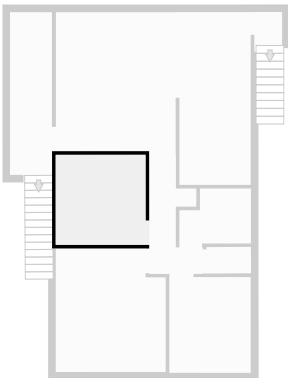

THIS FLOORPLAN IS PROVIDED WITHOUT WARRANTY OF ANY KIND. SENSOPIA DISCLAIMS ANY WARRANTY INCLUDING, WITHOUT LIMITATION, SATISFACTORY QUALITY OR ACCURACY OF DIMENSIONS.

Master Bedroom

Width: 3.64 m
 Length: 4.08 m
 Area: 14.24 m²
 Perimeter: 15.45 m

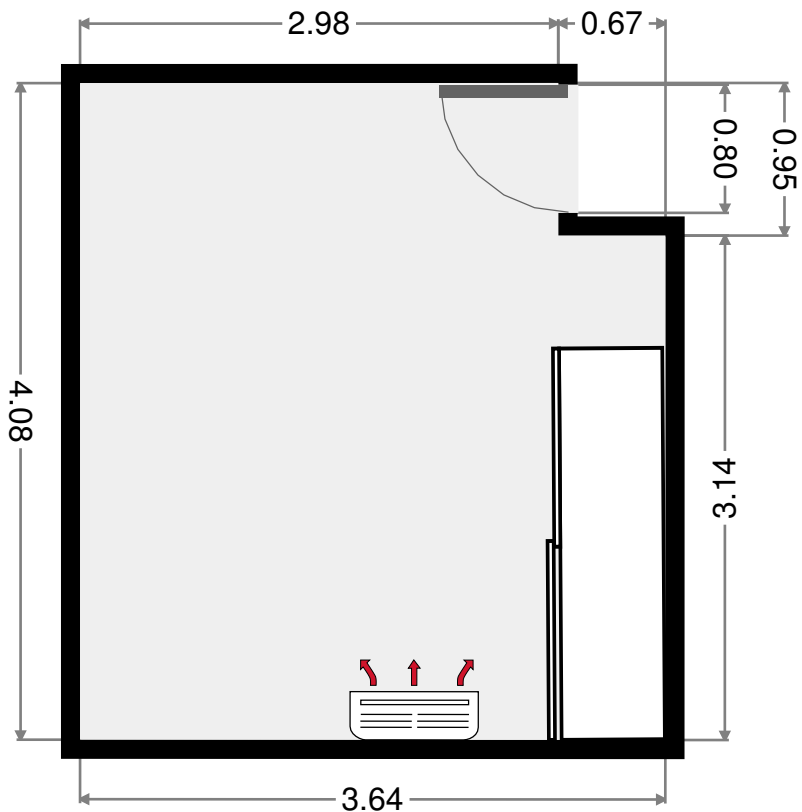
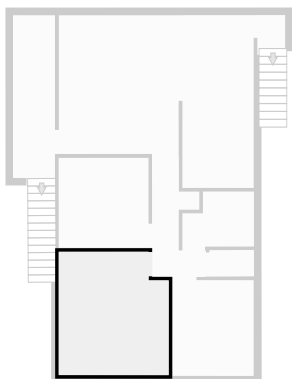

Bedroom

Width: 2.69 m
 Length: 3.18 m
 Area: 8.53 m²
 Perimeter: 11.73 m

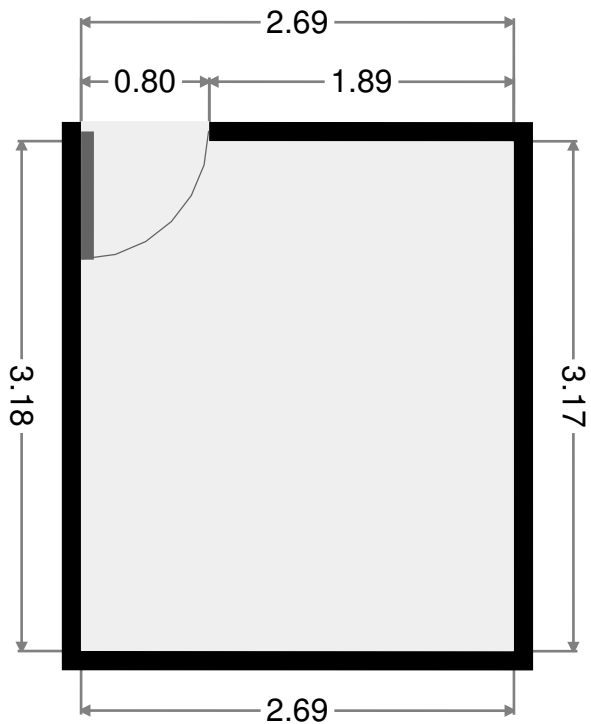
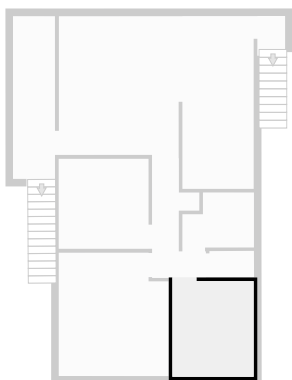

THIS FLOORPLAN IS PROVIDED WITHOUT WARRANTY OF ANY KIND. SENSOPIA DISCLAIMS ANY WARRANTY INCLUDING, WITHOUT LIMITATION, SATISFACTORY QUALITY OR ACCURACY OF DIMENSIONS.

Toilet

Width: 0.88 m
 Length: 1.47 m
 Area: 1.29 m²
 Perimeter: 4.70 m

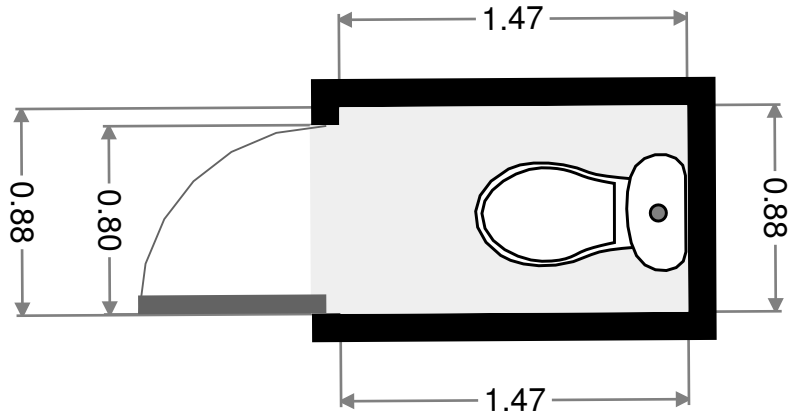
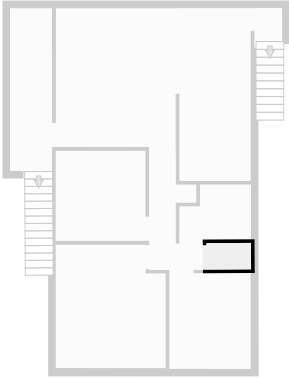

Bathroom

Width: 1.82 m
 Length: 2.37 m
 Area: 3.83 m²
 Perimeter: 8.38 m

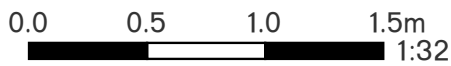
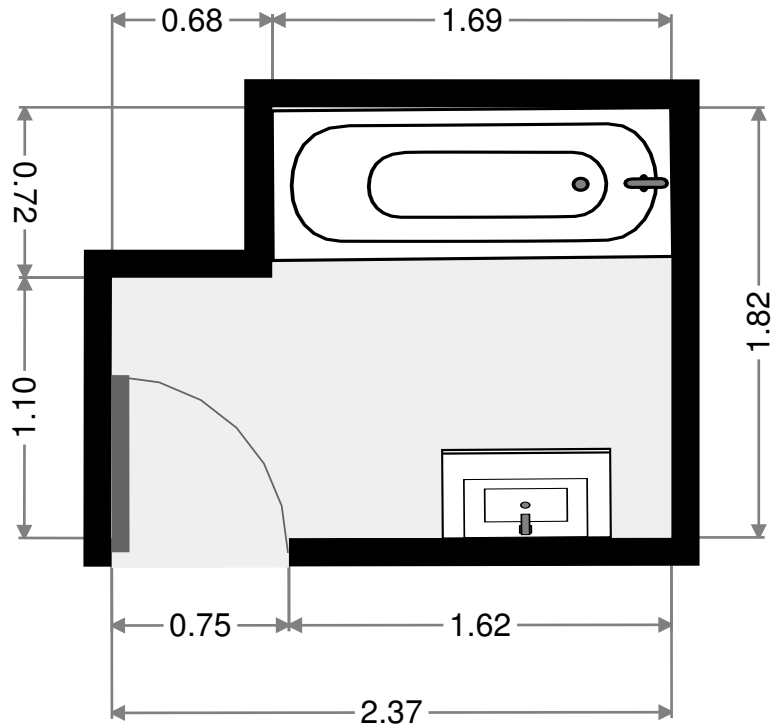
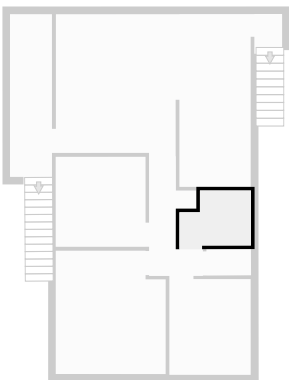

THIS FLOORPLAN IS PROVIDED WITHOUT WARRANTY OF ANY KIND. SENSOPIA DISCLAIMS ANY WARRANTY INCLUDING, WITHOUT LIMITATION, SATISFACTORY QUALITY OR ACCURACY OF DIMENSIONS.

Front Balcony

Width: 1.39 m
 Length: 5.39 m
 Area: 7.48 m²
 Perimeter: 13.55 m

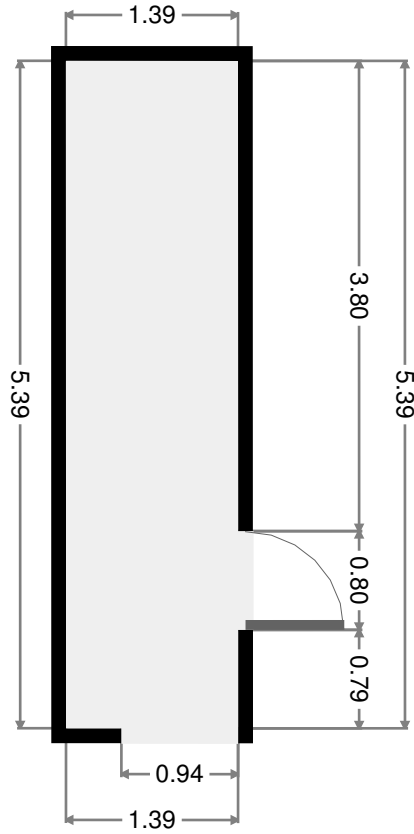
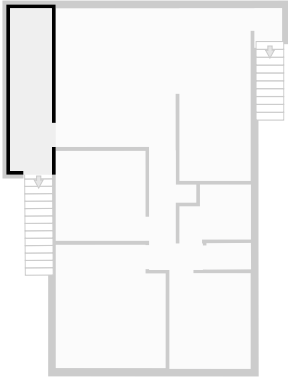

Hall

Width: 0.92 m
 Length: 0.95 m
 Area: 0.87 m²
 Perimeter: 3.73 m

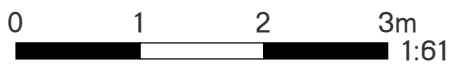
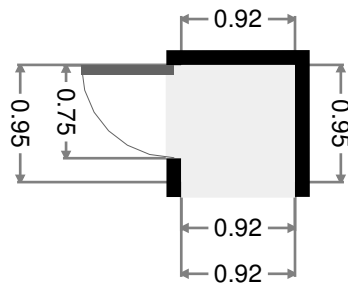
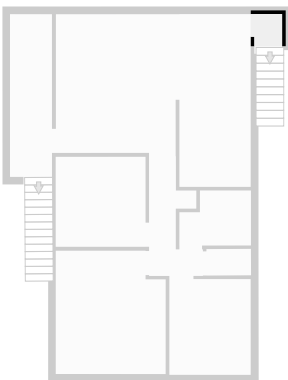

THIS FLOORPLAN IS PROVIDED WITHOUT WARRANTY OF ANY KIND. SENSOPIA DISCLAIMS ANY WARRANTY INCLUDING, WITHOUT LIMITATION, SATISFACTORY QUALITY OR ACCURACY OF DIMENSIONS.