

20 Lister Street

Ground Floor

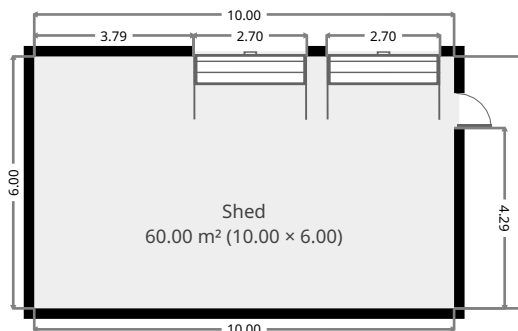
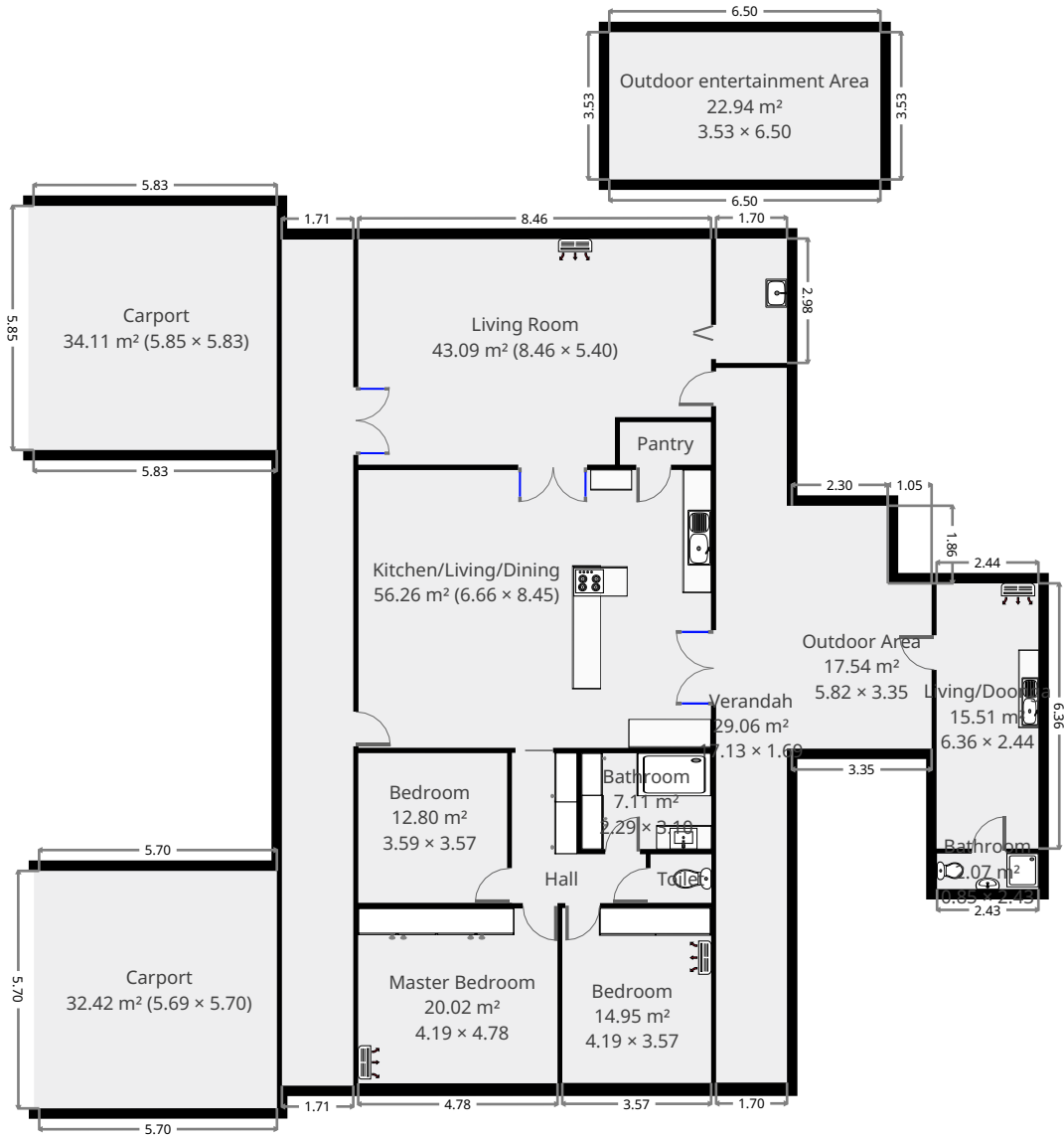

THIS FLOORPLAN IS PROVIDED WITHOUT WARRANTY OF ANY KIND. SENSOPIA DISCLAIMS ANY WARRANTY INCLUDING, WITHOUT LIMITATION, SATISFACTORY QUALITY OR ACCURACY OF DIMENSIONS.

20 Lister Street

Bathroom

Width: 2.29 m
 Length: 3.10 m
 Area: 7.11 m²
 Perimeter: 10.79 m

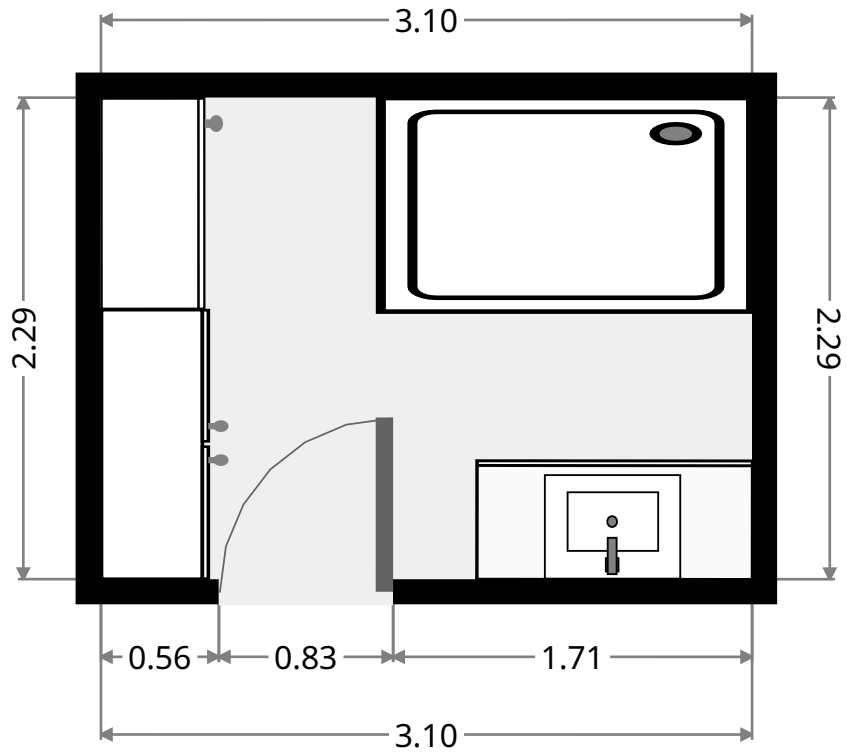
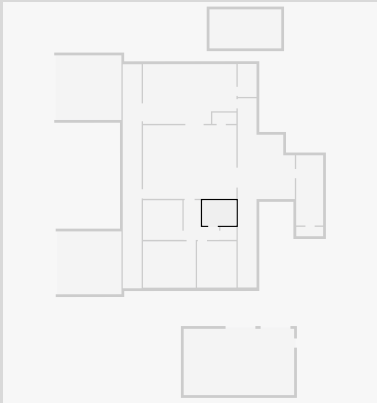

Bathroom

Width: 0.85 m
 Length: 2.43 m
 Area: 2.07 m²
 Perimeter: 6.56 m

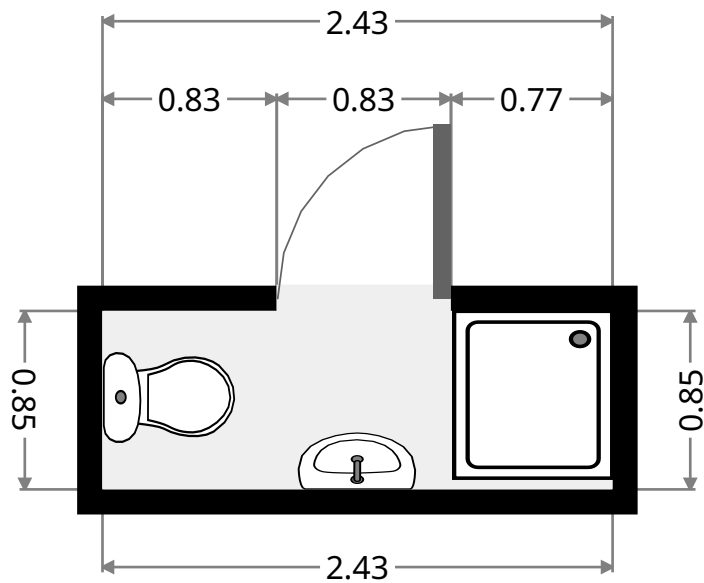
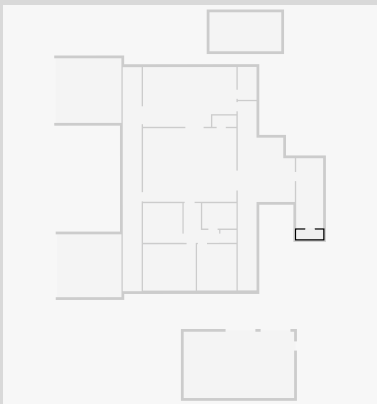

20 Lister Street

Living/Doonga

Width: 2.44 m
 Length: 6.36 m
 Area: 15.51 m²
 Perimeter: 17.59 m

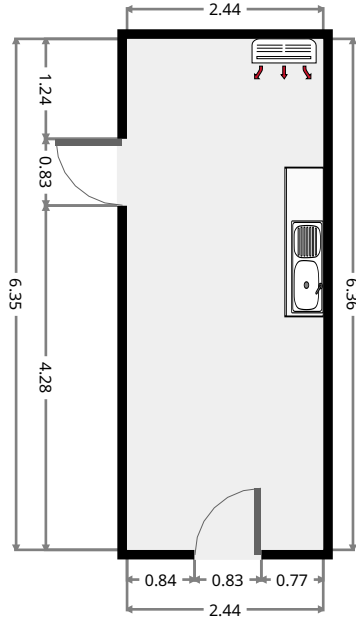
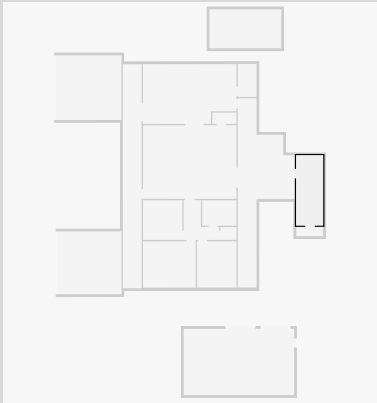

Shed

Width: 6.00 m
 Length: 10.00 m
 Area: 60.00 m²
 Perimeter: 32.00 m

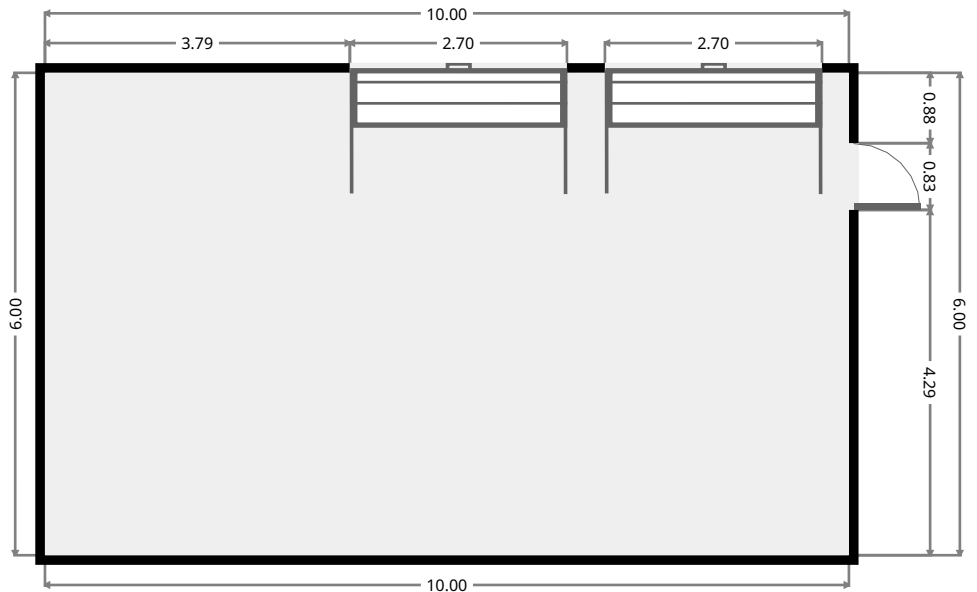
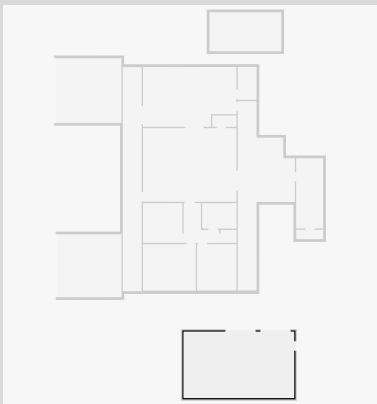

20 Lister Street

Outdoor entertainment Area

Width: 3.53 m
Length: 6.50 m
Area: 22.94 m²
Perimeter: 20.06 m

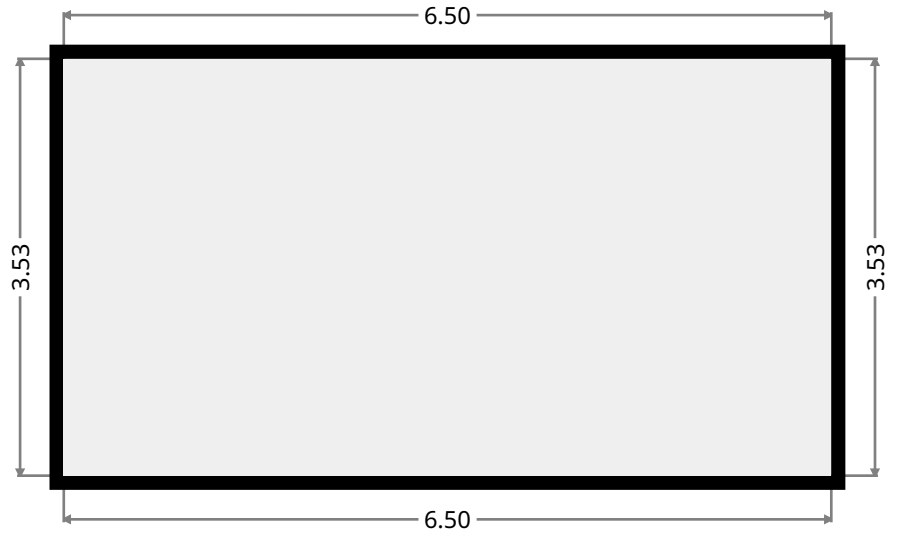
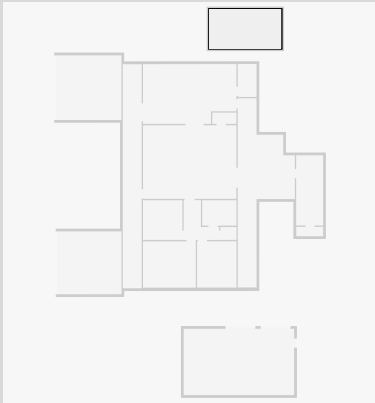

Carport

Width: 5.83 m
Length: 5.85 m
Area: 34.11 m²
Perimeter: 23.36 m

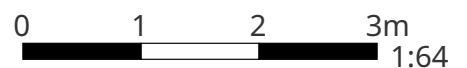
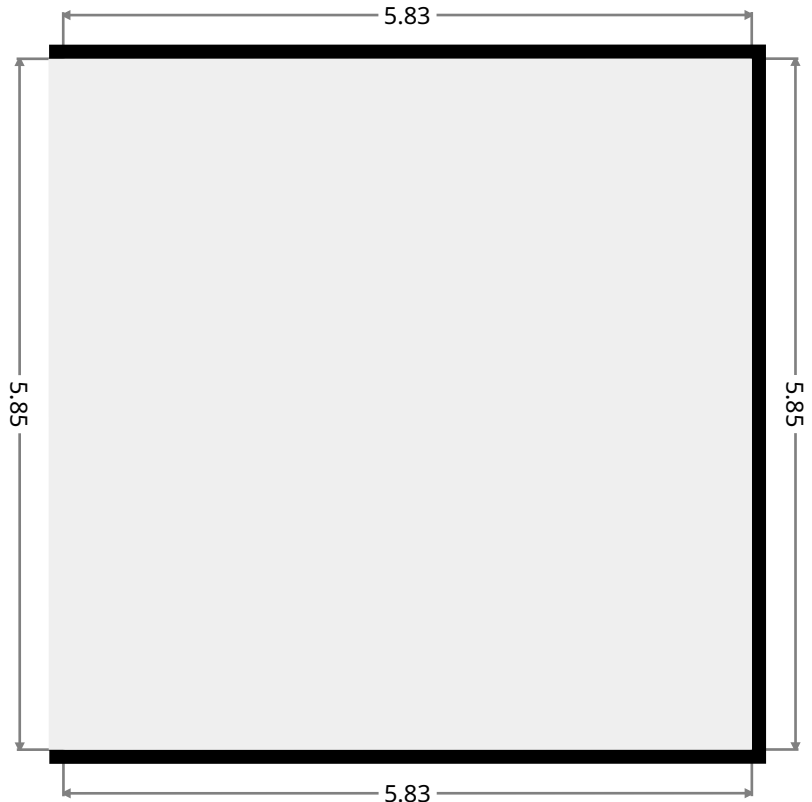
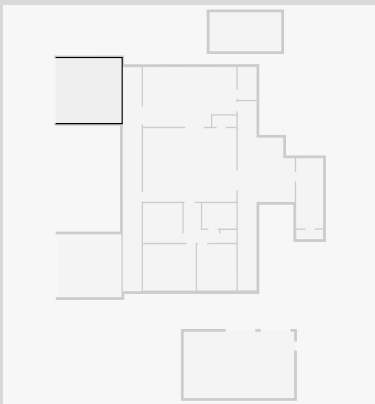

20 Lister Street

Carport

Width: 5.69 m
Length: 5.70 m
Area: 32.42 m²
Perimeter: 22.78 m

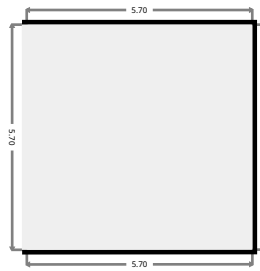
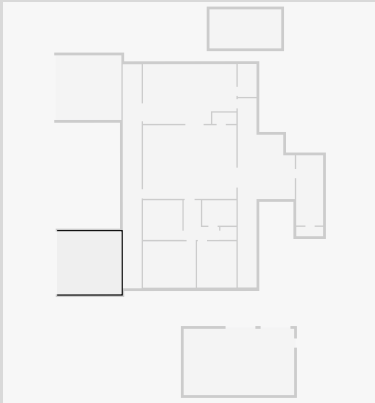

Front Verandah

Width: 1.71 m
Length: 20.28 m
Area: 34.72 m²
Perimeter: 43.98 m

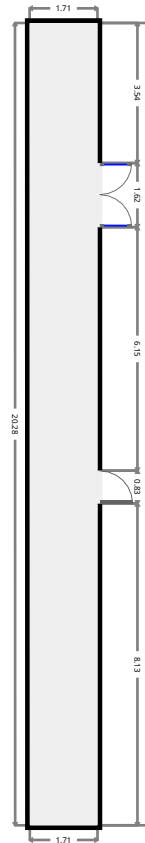
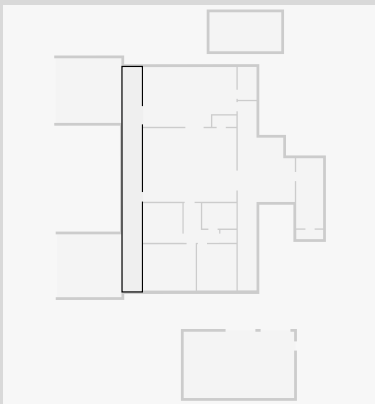

20 Lister Street

Verandah

Width: 1.69 m
Length: 17.13 m
Area: 29.06 m²
Perimeter: 37.65 m

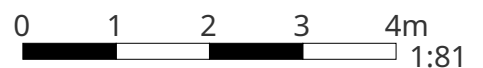
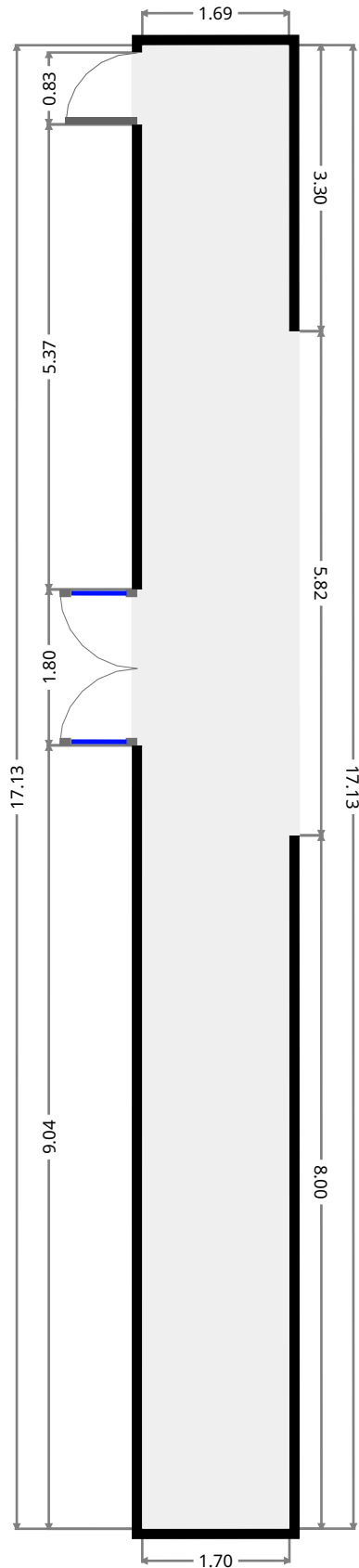

THIS FLOORPLAN IS PROVIDED WITHOUT WARRANTY OF ANY KIND. SENSOPIA DISCLAIMS ANY WARRANTY INCLUDING, WITHOUT LIMITATION, SATISFACTORY QUALITY OR ACCURACY OF DIMENSIONS.

20 Lister Street

Outdoor Area

Width: 3.35 m
 Length: 5.82 m
 Area: 17.54 m²
 Perimeter: 18.34 m

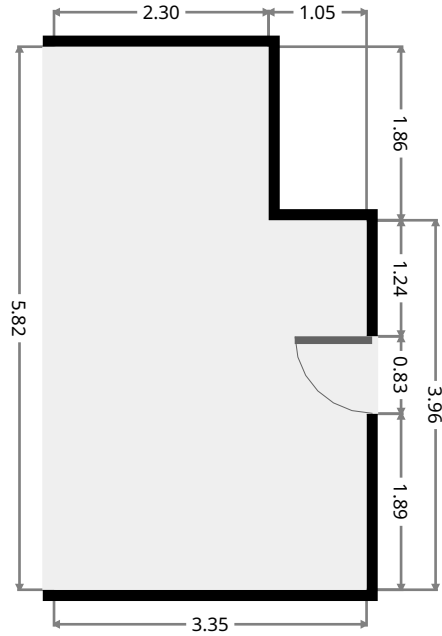

Kitchen/Living/Dining

Width: 6.66 m
 Length: 8.45 m
 Area: 56.26 m²
 Perimeter: 30.22 m

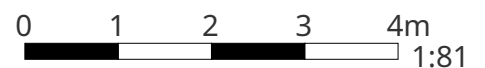
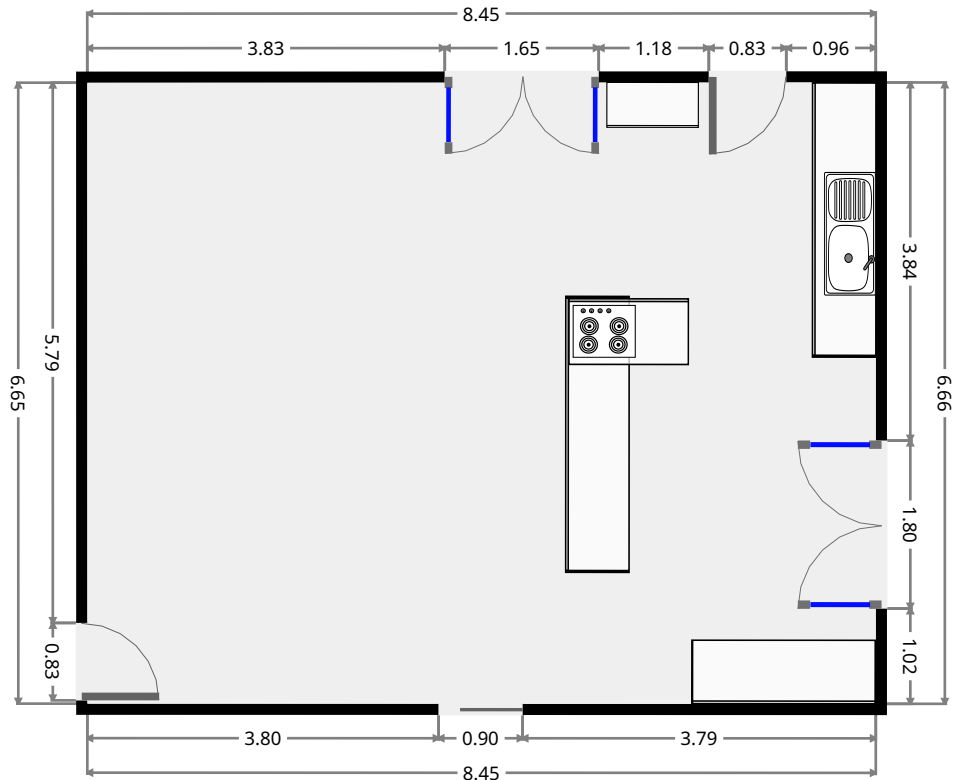
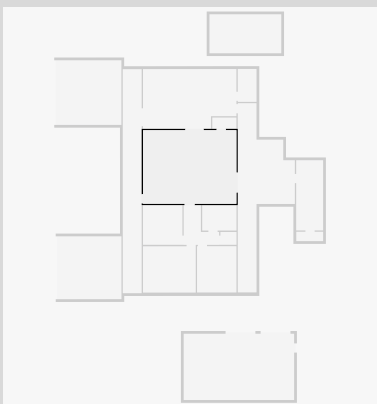

THIS FLOORPLAN IS PROVIDED WITHOUT WARRANTY OF ANY KIND. SENSOPIA DISCLAIMS ANY WARRANTY INCLUDING, WITHOUT LIMITATION, SATISFACTORY QUALITY OR ACCURACY OF DIMENSIONS.

20 Lister Street

Toilet

Width: 1.16 m
Length: 1.46 m
Area: 1.69 m²
Perimeter: 5.24 m

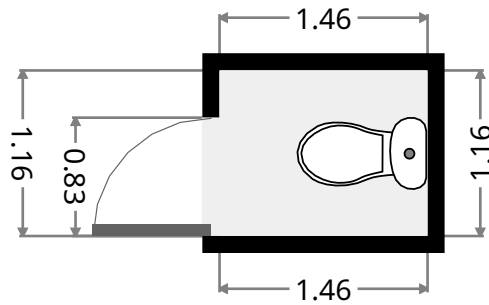
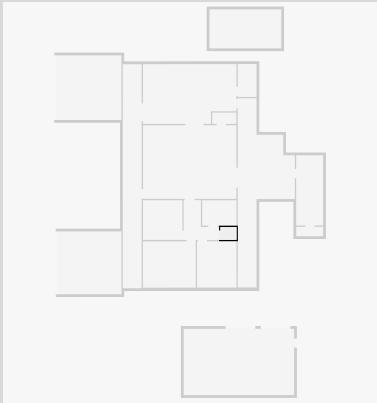

Bedroom

Width: 3.57 m
Length: 4.19 m
Area: 14.95 m²
Perimeter: 15.52 m

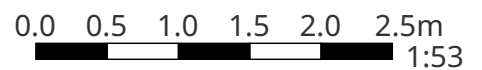
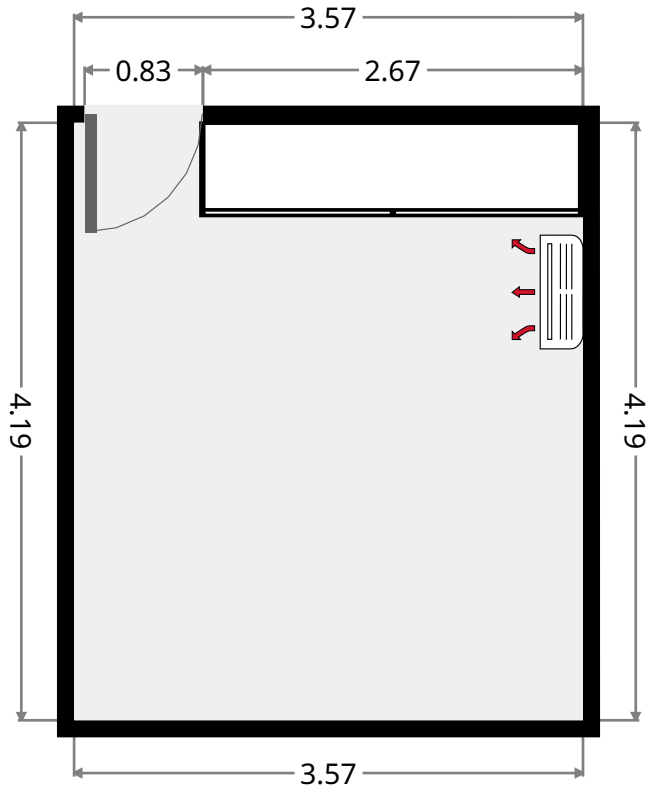
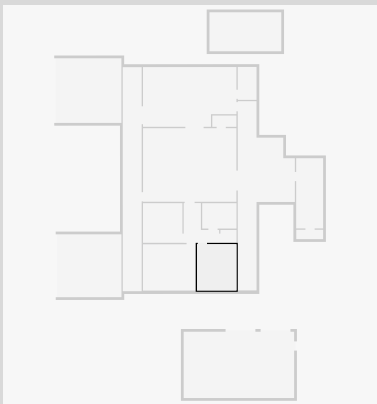

THIS FLOORPLAN IS PROVIDED WITHOUT WARRANTY OF ANY KIND. SENSOPIA DISCLAIMS ANY WARRANTY INCLUDING, WITHOUT LIMITATION, SATISFACTORY QUALITY OR ACCURACY OF DIMENSIONS.

20 Lister Street

Master Bedroom

Width: 4.19 m
 Length: 4.78 m
 Area: 20.02 m²
 Perimeter: 17.94 m

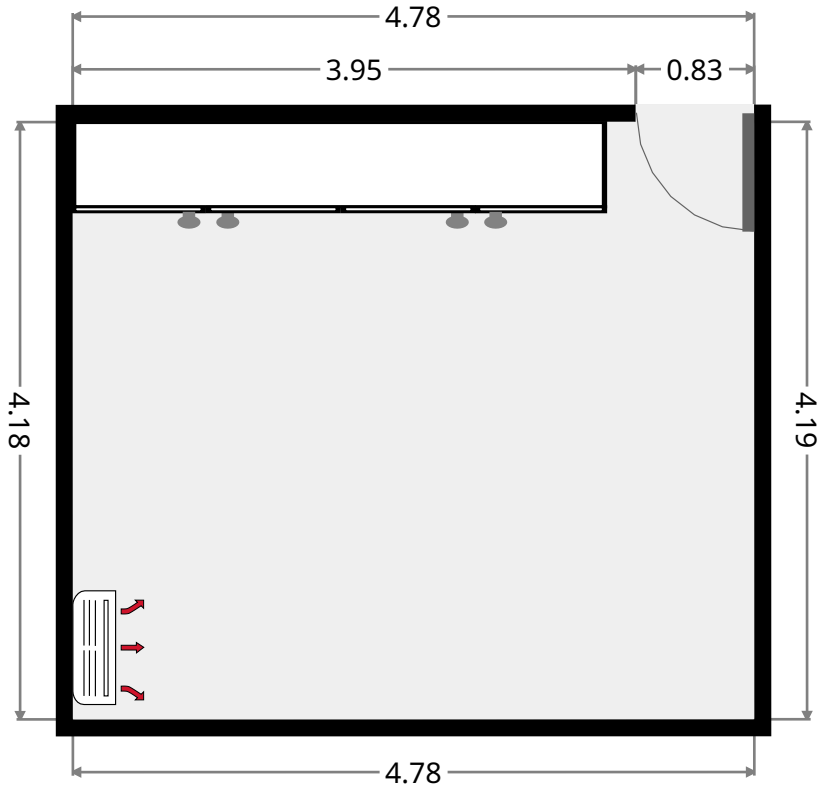
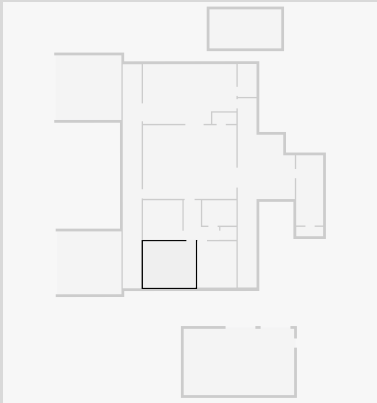

Bedroom

Width: 3.57 m
 Length: 3.59 m
 Area: 12.80 m²
 Perimeter: 14.31 m

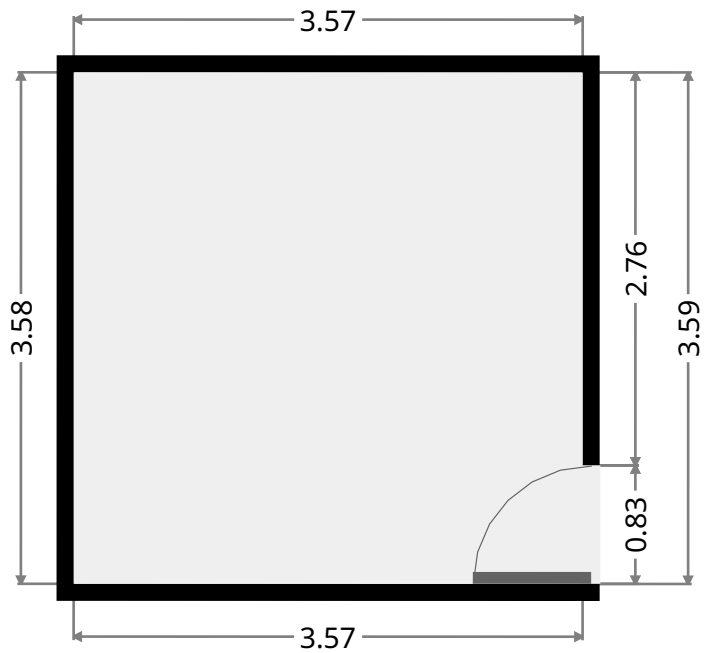
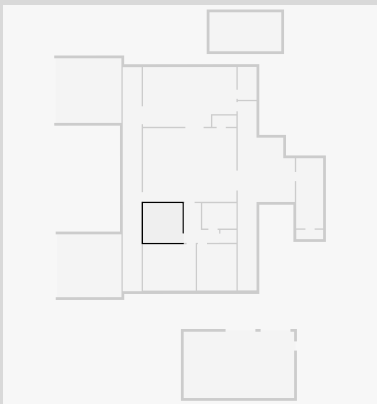

THIS FLOORPLAN IS PROVIDED WITHOUT WARRANTY OF ANY KIND. SENSOPIA DISCLAIMS ANY WARRANTY INCLUDING, WITHOUT LIMITATION, SATISFACTORY QUALITY OR ACCURACY OF DIMENSIONS.

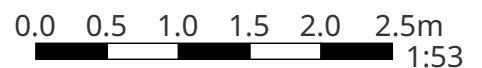

20 Lister Street

Hall

Width: 3.21 m
 Length: 3.60 m
 Area: 7.54 m²
 Perimeter: 13.62 m

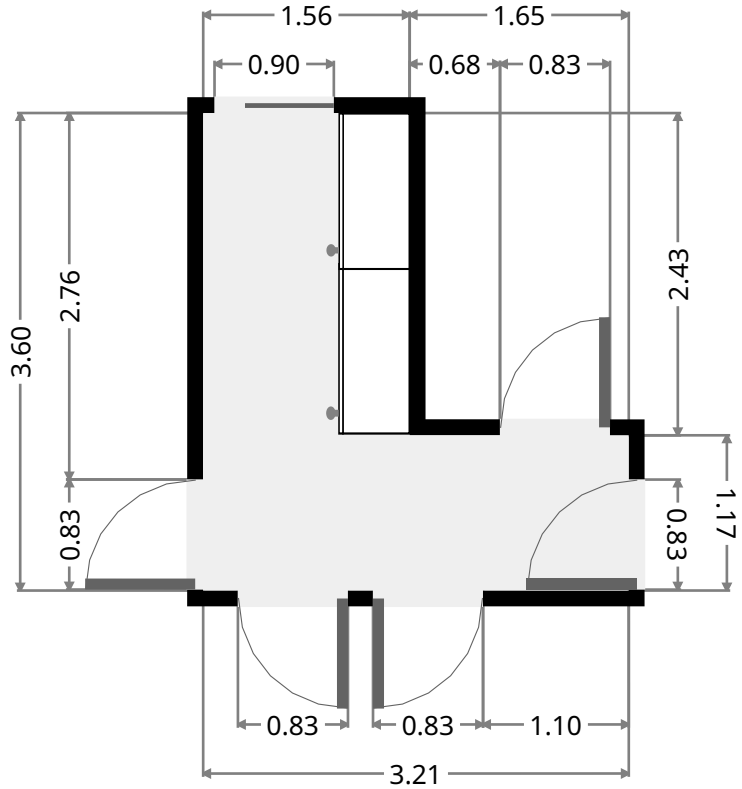
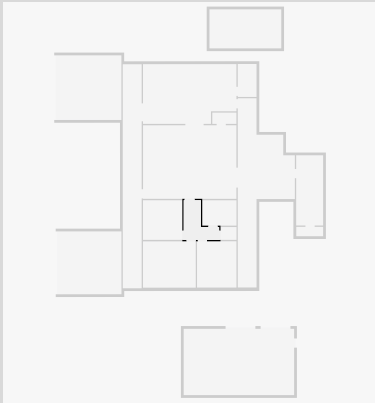

Laundry Room

Width: 1.70 m
 Length: 2.98 m
 Area: 5.07 m²
 Perimeter: 9.36 m

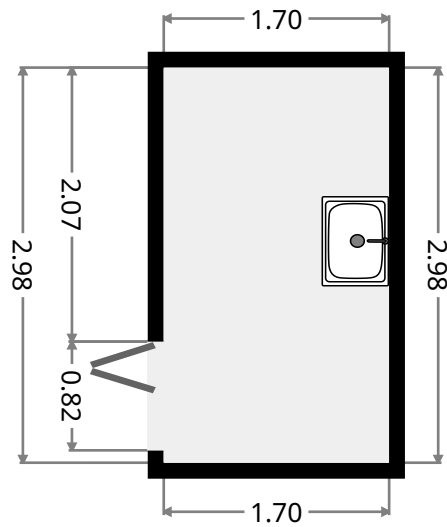
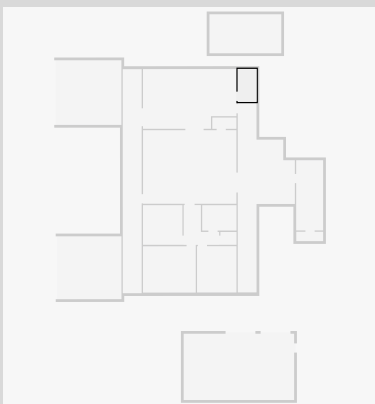

20 Lister Street

Living Room

Width: 5.40 m
 Length: 8.46 m
 Area: 43.09 m²
 Perimeter: 27.73 m

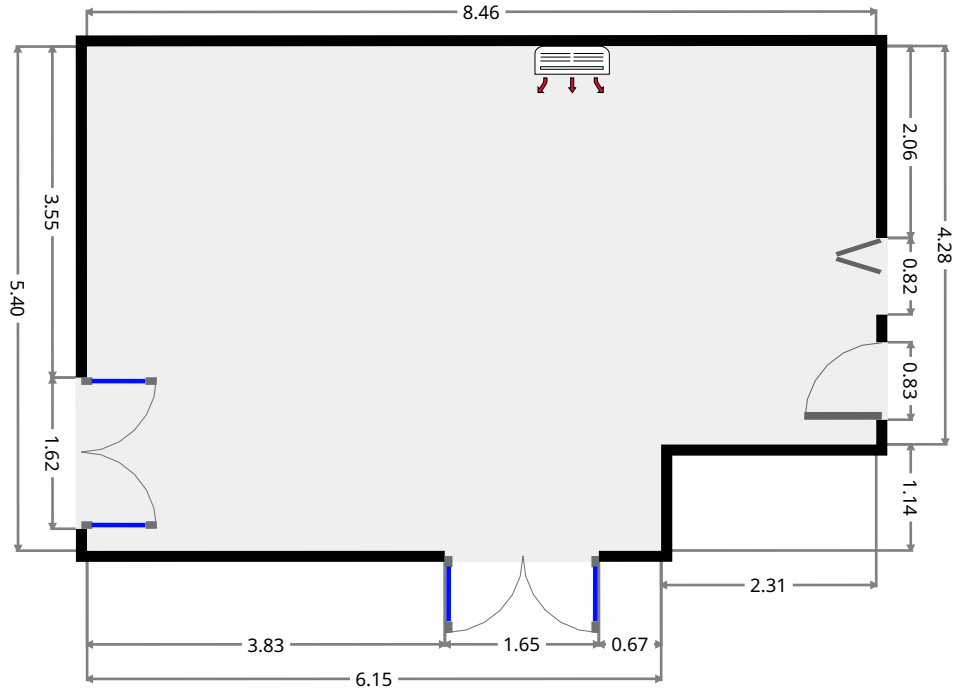
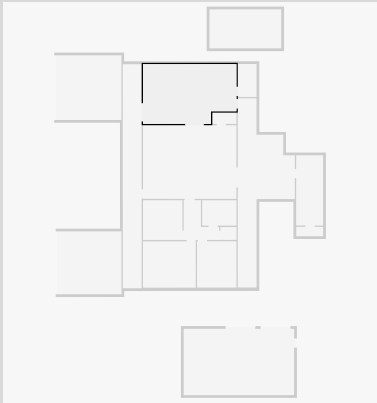

Pantry

Width: 1.02 m
 Length: 2.18 m
 Area: 2.22 m²
 Perimeter: 6.40 m

