

Ground Floor

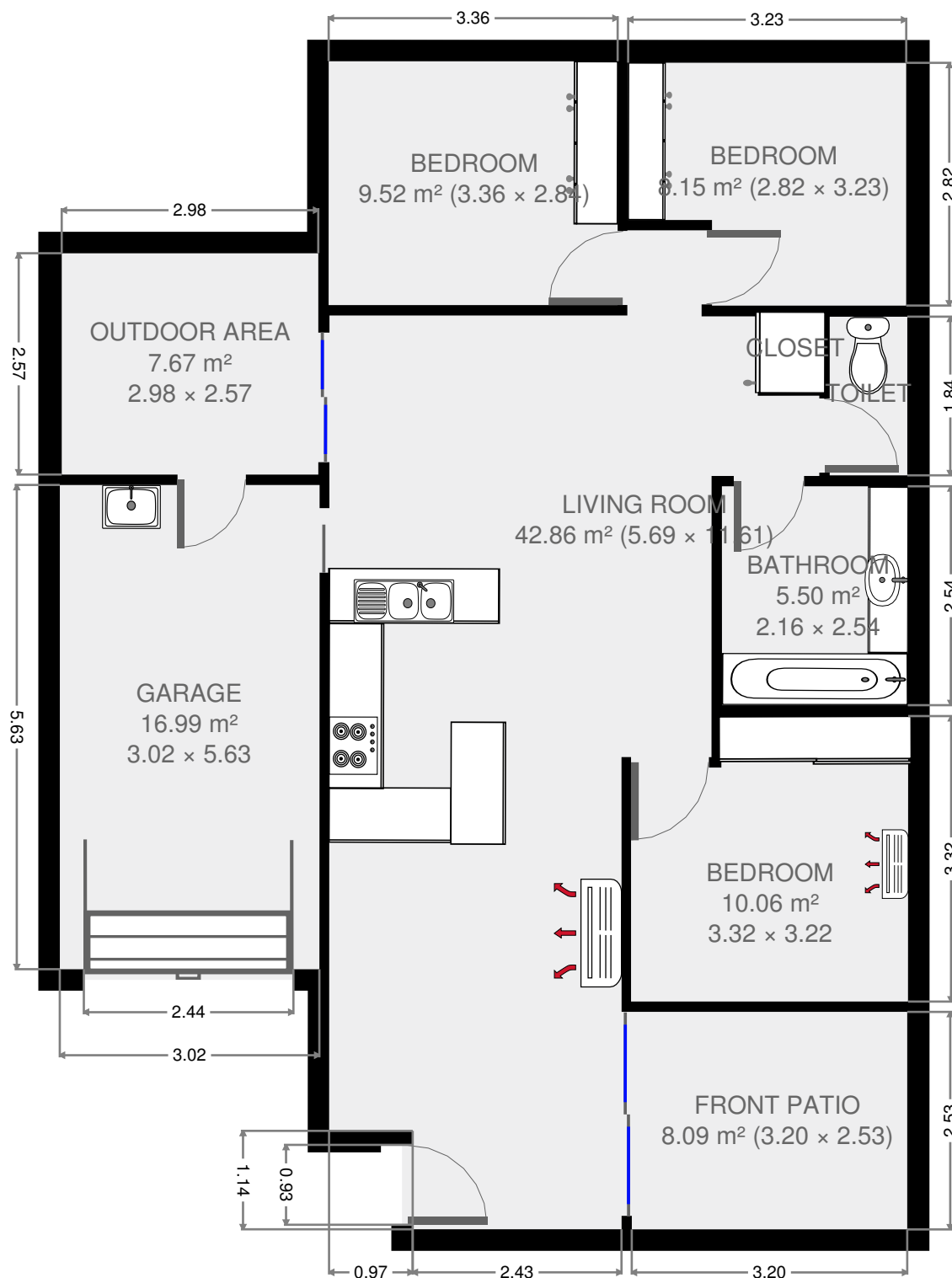

THIS FLOORPLAN IS PROVIDED WITHOUT WARRANTY OF ANY KIND. SENSOPIA DISCLAIMS ANY WARRANTY INCLUDING, WITHOUT LIMITATION, SATISFACTORY QUALITY OR ACCURACY OF DIMENSIONS.

2/17 Meyenberg Court

Living Room

Width: 5.69 m
 Length: 11.61 m
 Area: 42.86 m²
 Perimeter: 34.62 m
 Ceiling Height: 2.17 m

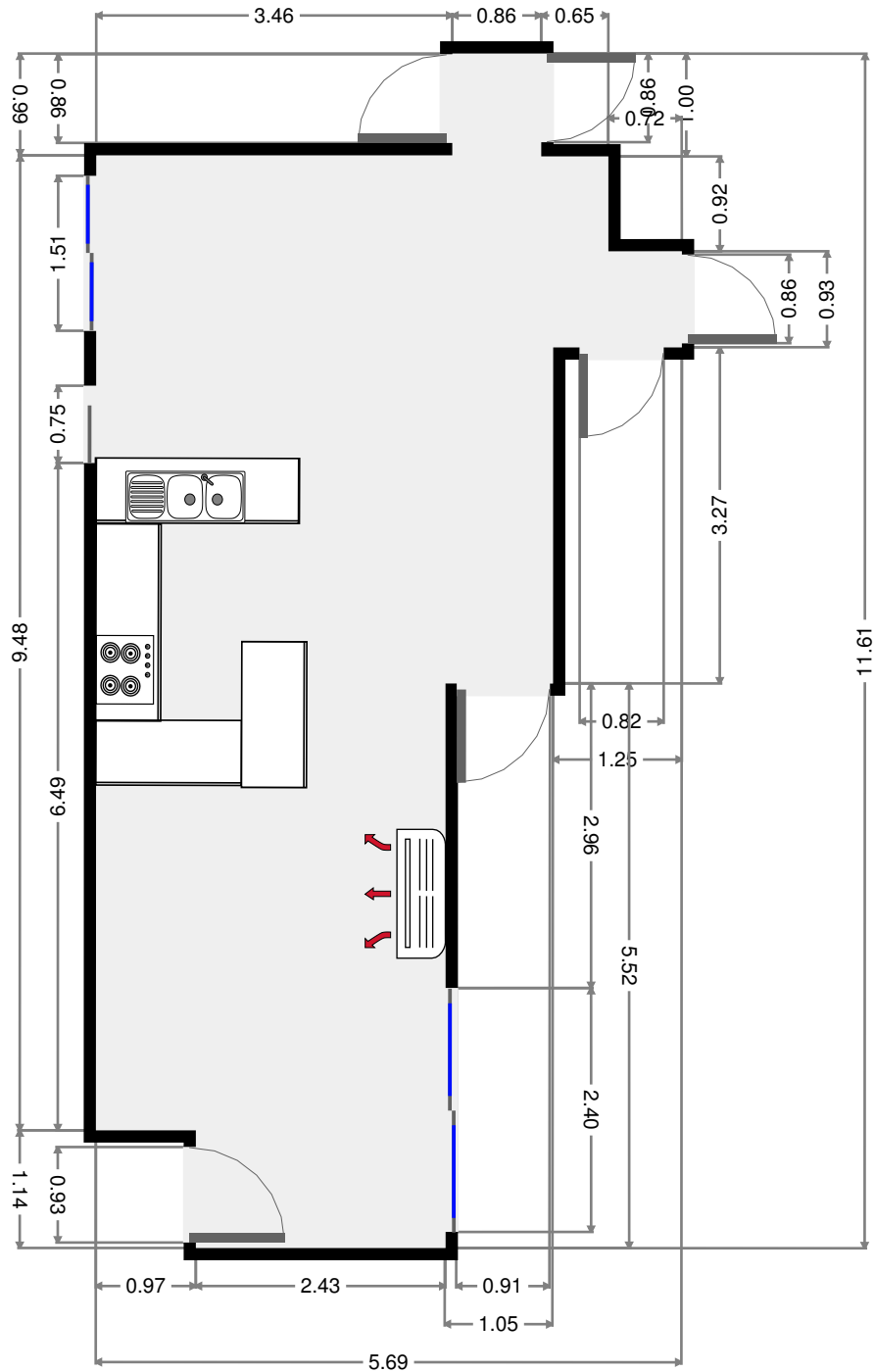
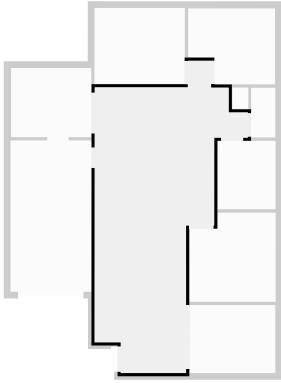

THIS FLOORPLAN IS PROVIDED WITHOUT WARRANTY OF ANY KIND. SENSOPIA DISCLAIMS ANY WARRANTY INCLUDING, WITHOUT LIMITATION, SATISFACTORY QUALITY OR ACCURACY OF DIMENSIONS.

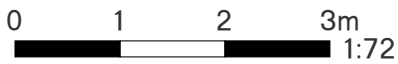

2/17 Meyenberg Court

2017-01-05

Bedroom

Width: 3.22 m
 Length: 3.32 m
 Area: 10.06 m²
 Perimeter: 13.08 m
 Ceiling Height: 2.17 m

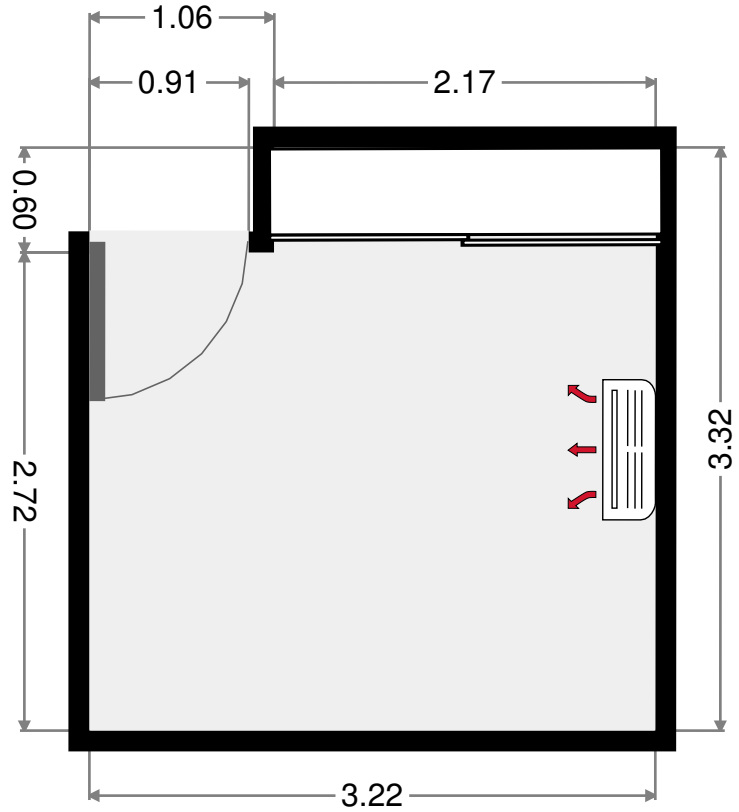
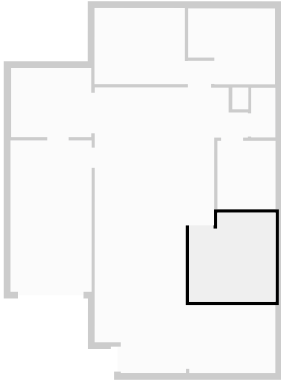

Bathroom

Width: 2.16 m
 Length: 2.54 m
 Area: 5.50 m²
 Perimeter: 9.41 m

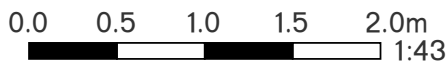
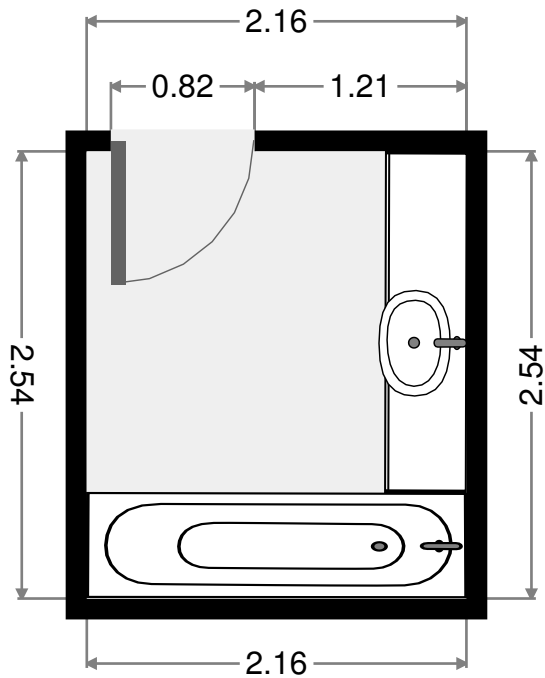
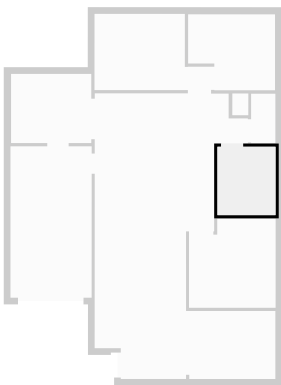

THIS FLOORPLAN IS PROVIDED WITHOUT WARRANTY OF ANY KIND. SENSOPIA DISCLAIMS ANY WARRANTY INCLUDING, WITHOUT LIMITATION, SATISFACTORY QUALITY OR ACCURACY OF DIMENSIONS.

Toilet

Width: 0.90 m
 Length: 1.84 m
 Area: 1.66 m²
 Perimeter: 5.49 m

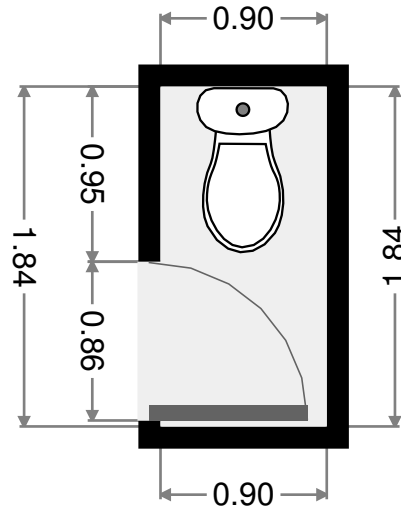
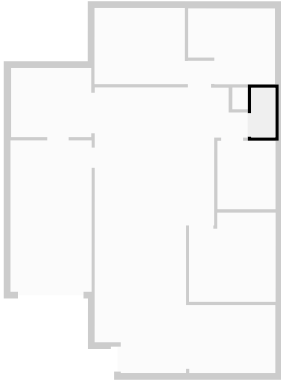

Bedroom

Width: 2.82 m
 Length: 3.23 m
 Area: 8.15 m²
 Perimeter: 12.11 m
 Ceiling Height: 2.17 m

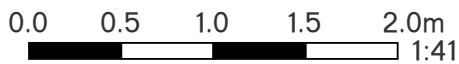
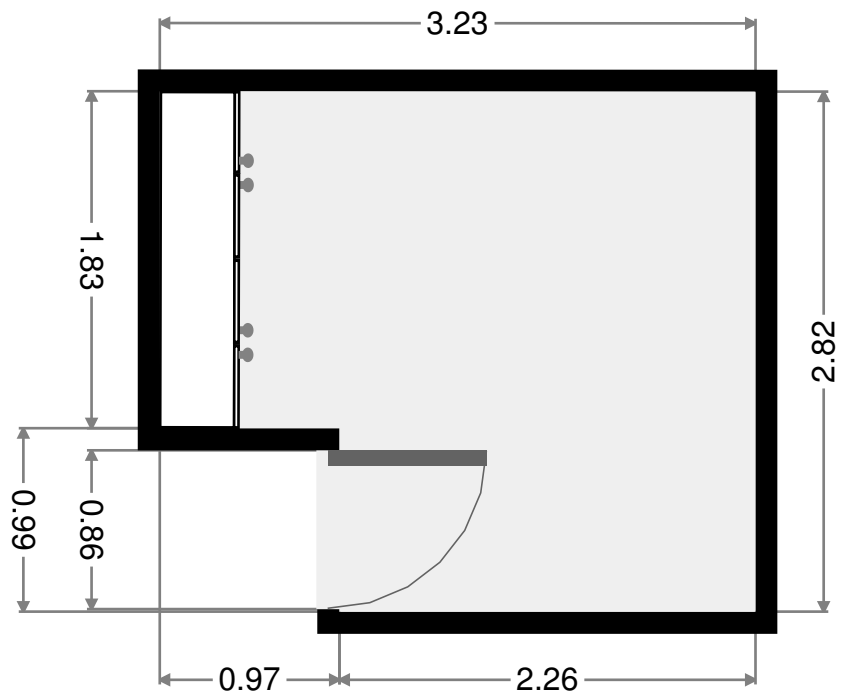
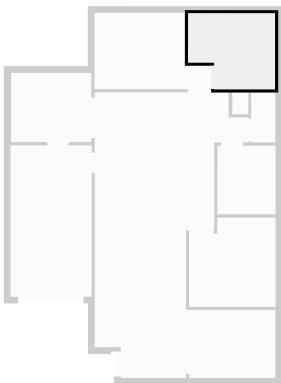

THIS FLOORPLAN IS PROVIDED WITHOUT WARRANTY OF ANY KIND. SENSOPIA DISCLAIMS ANY WARRANTY INCLUDING, WITHOUT LIMITATION, SATISFACTORY QUALITY OR ACCURACY OF DIMENSIONS.

Closet

Width: 0.59 m
Length: 0.81 m
Area: 0.48 m²
Perimeter: 2.80 m

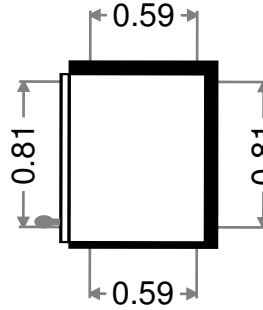
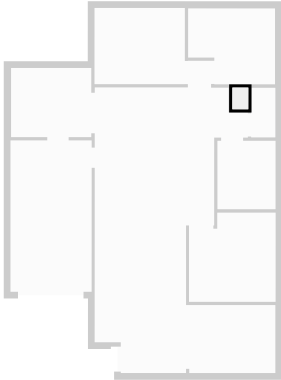

Bedroom

Width: 2.84 m
Length: 3.36 m
Area: 9.52 m²
Perimeter: 12.39 m

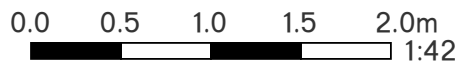
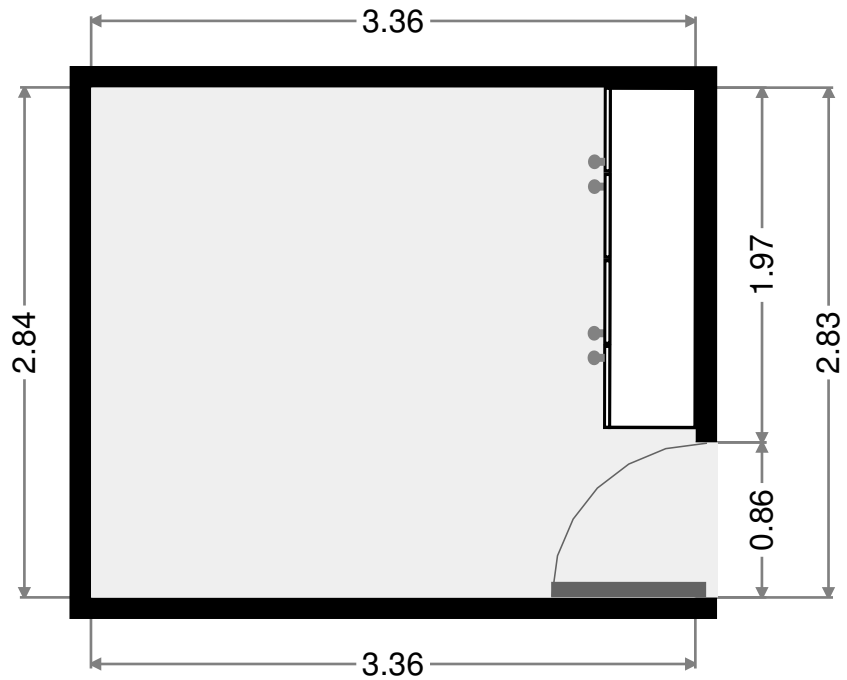
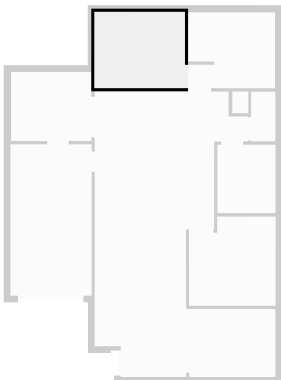

THIS FLOORPLAN IS PROVIDED WITHOUT WARRANTY OF ANY KIND. SENSOPIA DISCLAIMS ANY WARRANTY INCLUDING, WITHOUT LIMITATION, SATISFACTORY QUALITY OR ACCURACY OF DIMENSIONS.

Garage

Width: 3.02 m
 Length: 5.63 m
 Area: 16.99 m²
 Perimeter: 17.29 m

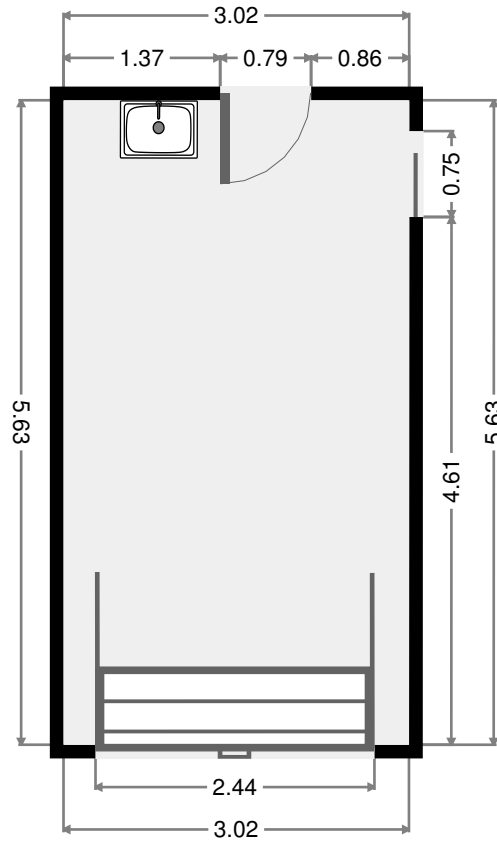
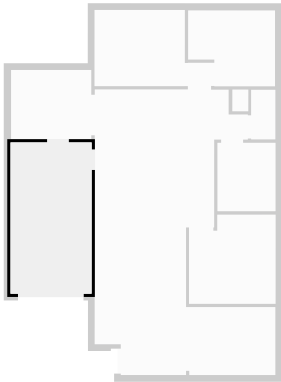

Outdoor Area

Width: 2.57 m
 Length: 2.98 m
 Area: 7.67 m²
 Perimeter: 11.11 m

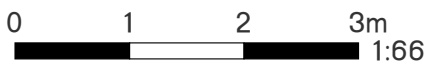
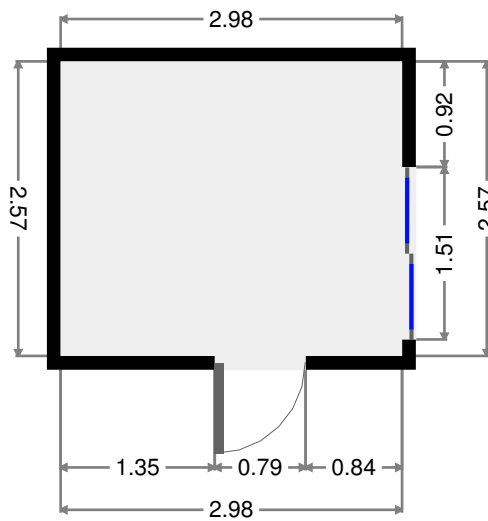
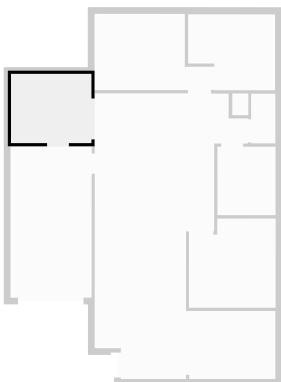

THIS FLOORPLAN IS PROVIDED WITHOUT WARRANTY OF ANY KIND. SENSOPIA DISCLAIMS ANY WARRANTY INCLUDING, WITHOUT LIMITATION, SATISFACTORY QUALITY OR ACCURACY OF DIMENSIONS.

Front Patio

Width: 2.53 m
Length: 3.20 m
Area: 8.09 m²
Perimeter: 11.46 m

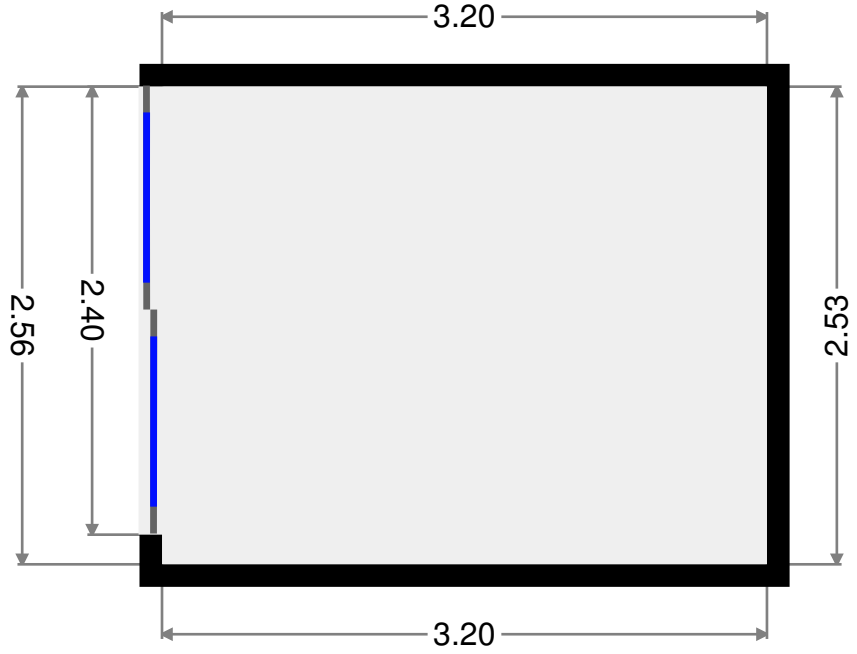
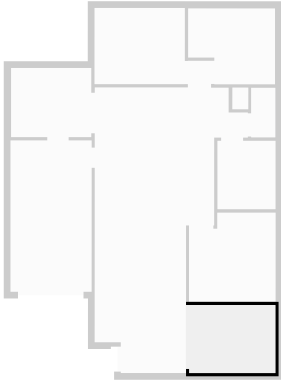

THIS FLOORPLAN IS PROVIDED WITHOUT WARRANTY OF ANY KIND. SENSOPIA DISCLAIMS ANY WARRANTY INCLUDING, WITHOUT LIMITATION, SATISFACTORY QUALITY OR ACCURACY OF DIMENSIONS.

