

# 18 Davey Avenue

Created on  
2021-05-26

Floors  
1

▼ Ground Floor



▼ **Bathroom**  
Ground Floor

WIDTH: 1.89 m • LENGTH: 2.03 m  
AREA: 3.84 m<sup>2</sup> • PERIMETER: 7.84 m

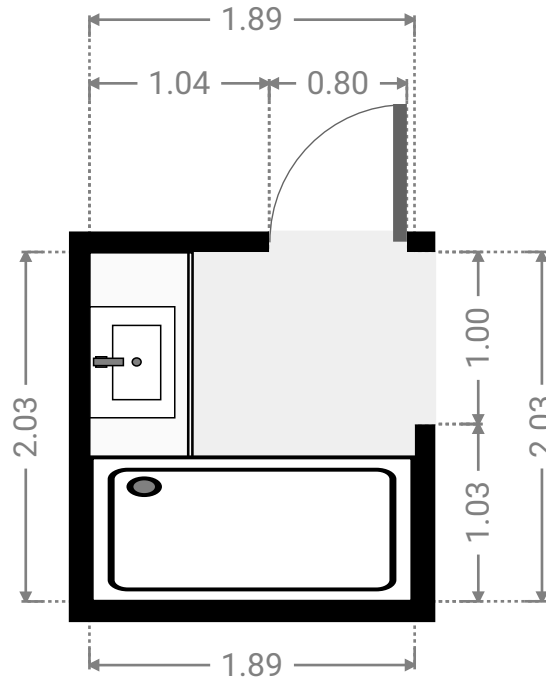
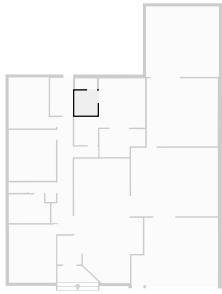

▼ **Other**  
Ground Floor

WIDTH: 3.48 m • LENGTH: 1.39 m  
AREA: 3.80 m<sup>2</sup> • PERIMETER: 8.90 m

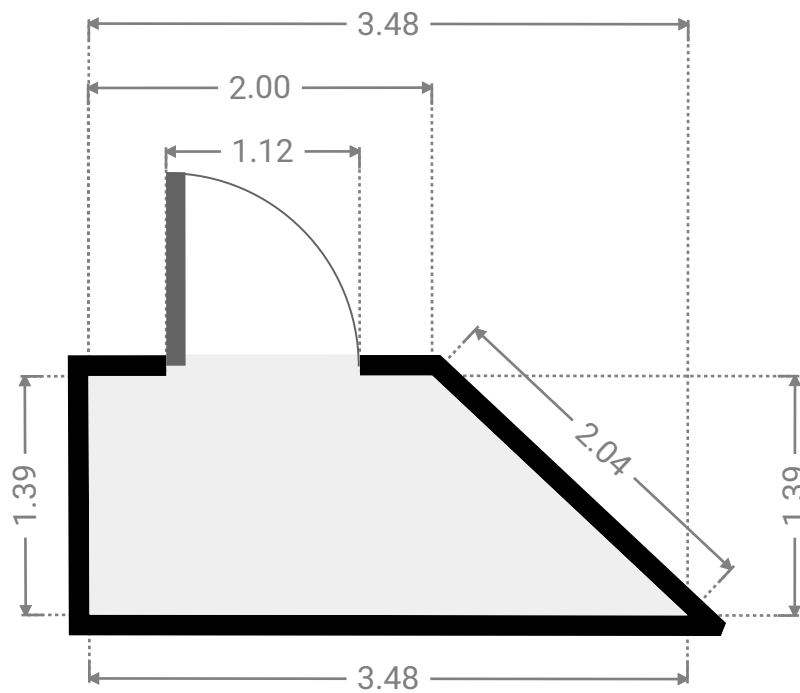
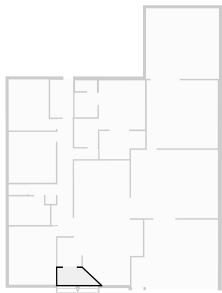

▼ **Other**  
Ground Floor

WIDTH: 6.00 m • LENGTH: 5.80 m  
AREA: 34.80 m<sup>2</sup> • PERIMETER: 23.60 m

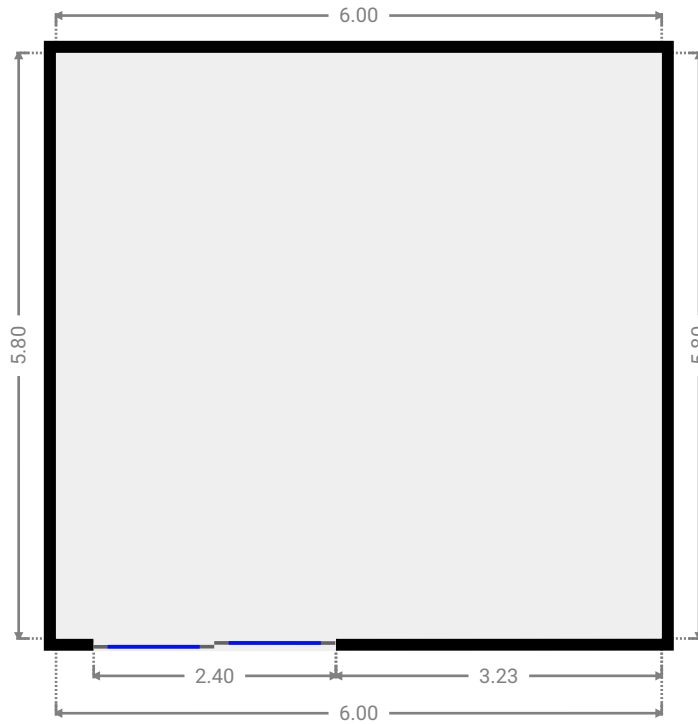
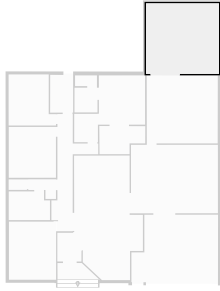

▼ **Living Room**  
Ground Floor

WIDTH: 5.85 m • LENGTH: 5.60 m  
AREA: 32.69 m<sup>2</sup> • PERIMETER: 22.87 m

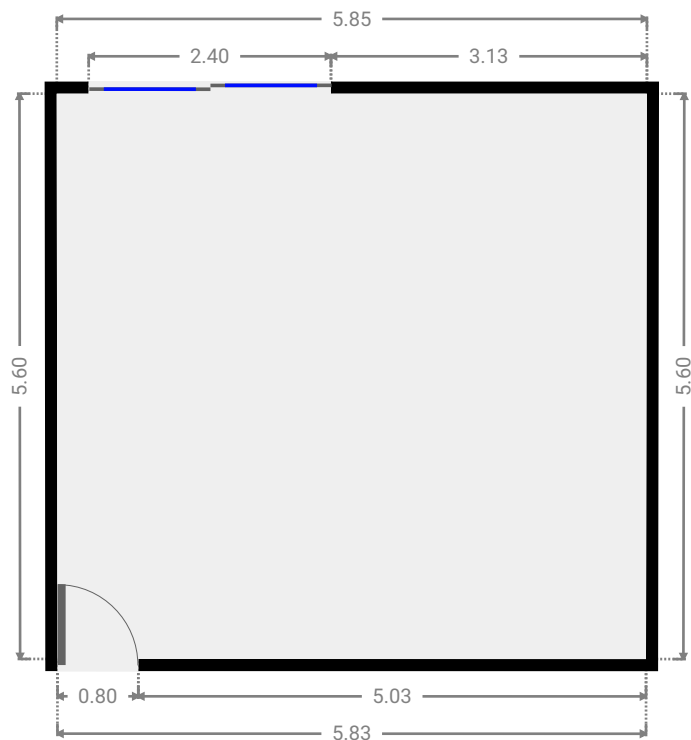
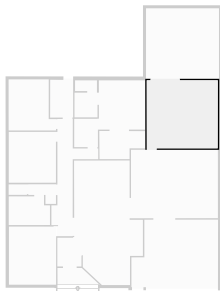

▼ **Garage**  
Ground Floor

WIDTH: 7.12 m • LENGTH: 5.57 m  
AREA: 36.29 m<sup>2</sup> • PERIMETER: 25.36 m

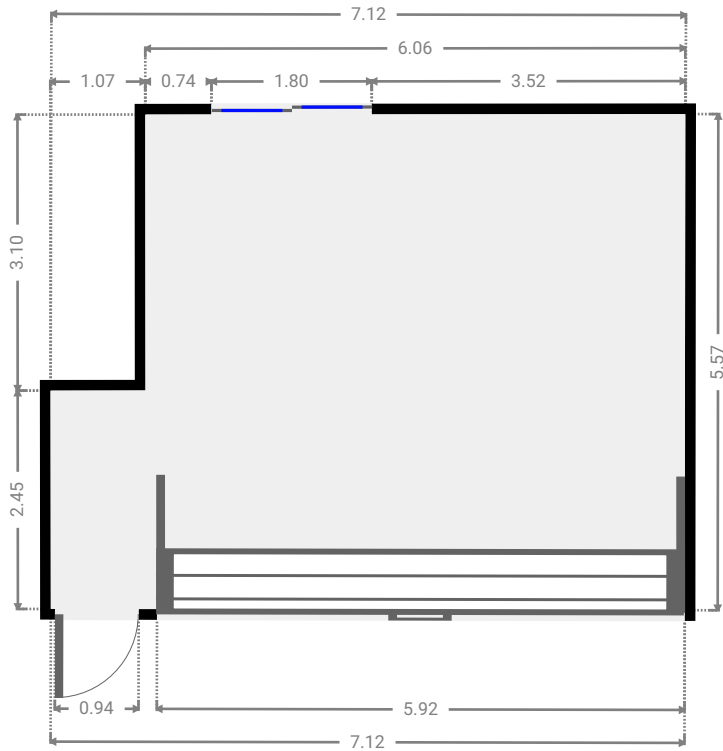
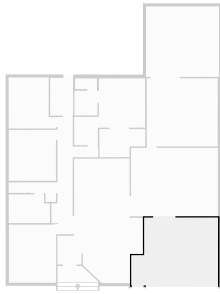

▼ **Living Room**  
Ground Floor

WIDTH: 7.15 m • LENGTH: 5.63 m  
AREA: 40.26 m<sup>2</sup> • PERIMETER: 25.56 m

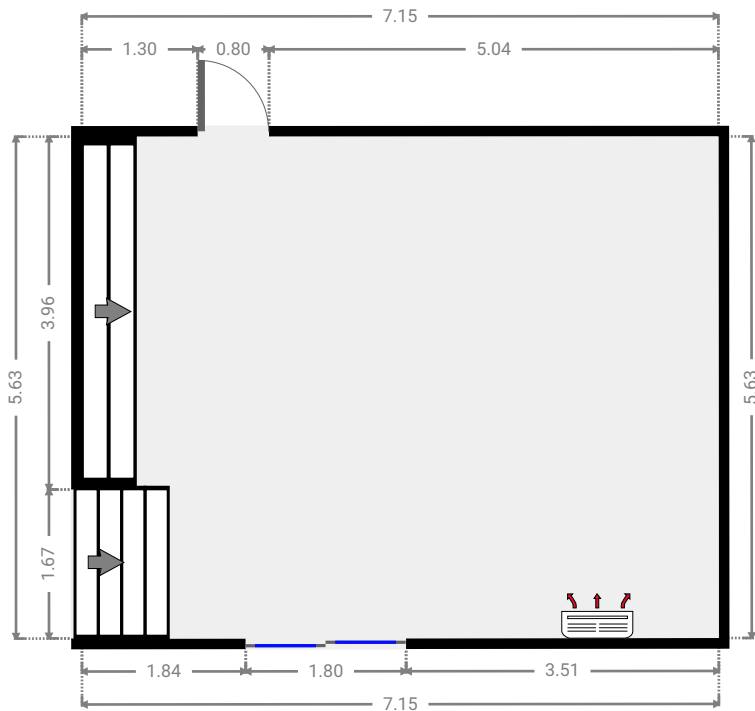
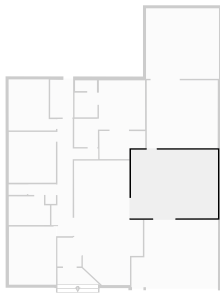

▼ Laundry Room  
Ground Floor

WIDTH: 1.89 m • LENGTH: 3.11 m  
AREA: 5.85 m<sup>2</sup> • PERIMETER: 9.97 m

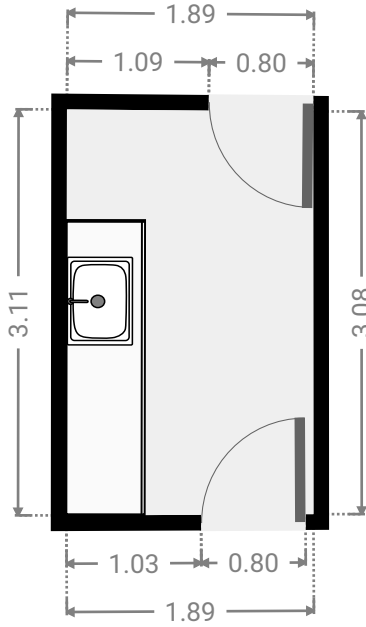
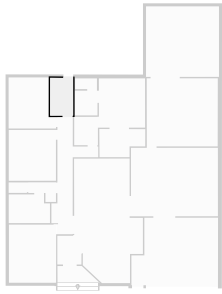

▼ Bedroom  
Ground Floor

WIDTH: 3.90 m • LENGTH: 4.20 m  
AREA: 14.41 m<sup>2</sup> • PERIMETER: 16.19 m

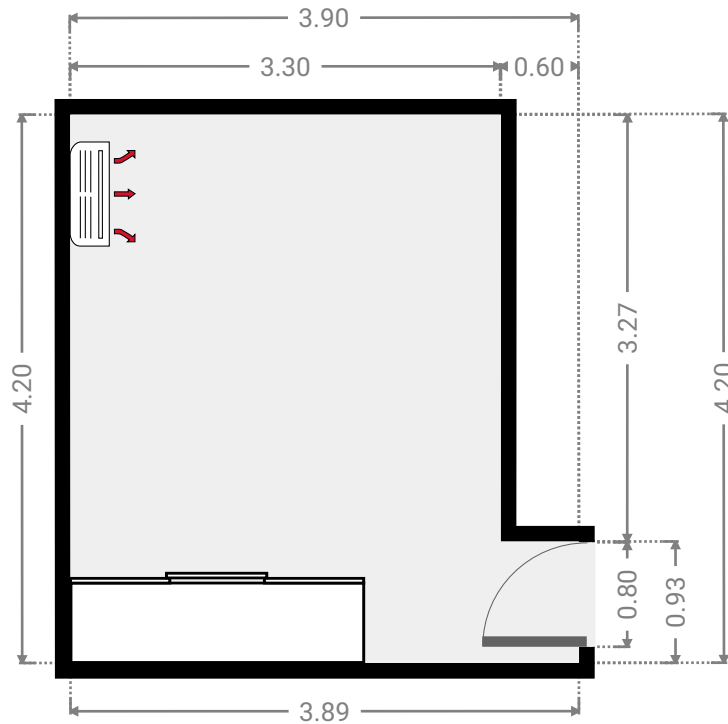
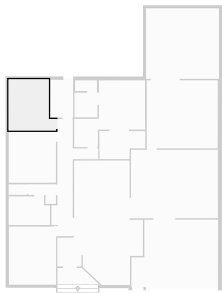

▼ **Bedroom**  
Ground Floor

WIDTH: 3.88 m • LENGTH: 4.18 m  
AREA: 16.22 m<sup>2</sup> • PERIMETER: 16.12 m

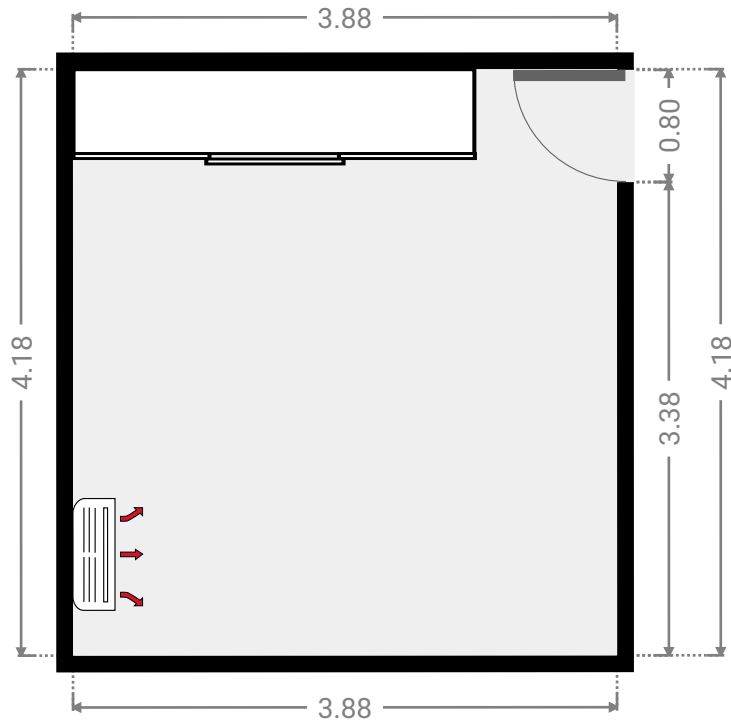
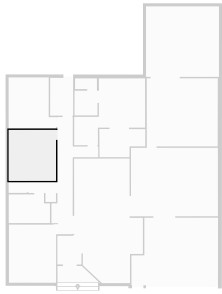

▼ **Closet**  
Ground Floor

WIDTH: 3.78 m • LENGTH: 2.32 m  
AREA: 7.56 m<sup>2</sup> • PERIMETER: 12.16 m

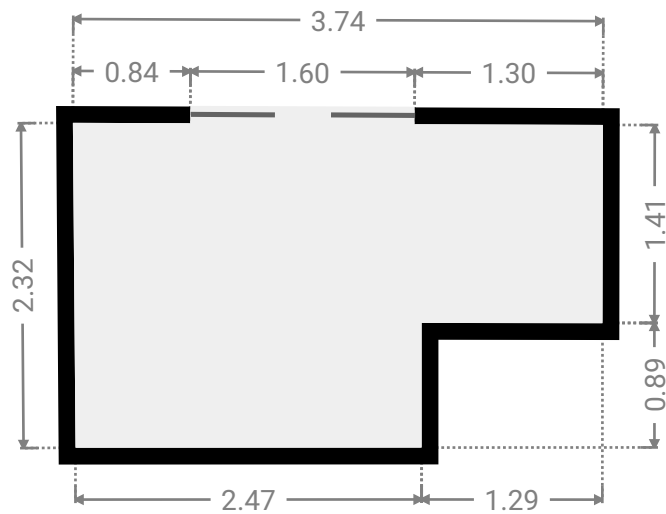
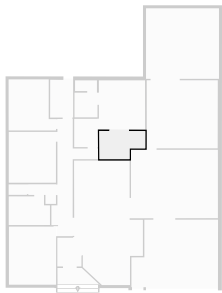

▼ **Toilet**  
Ground Floor

WIDTH: 1.80 m • LENGTH: 0.88 m  
AREA: 1.58 m<sup>2</sup> • PERIMETER: 5.36 m

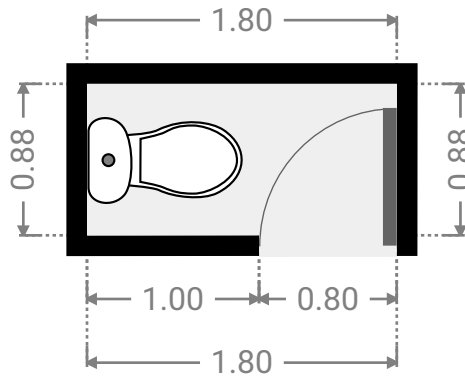
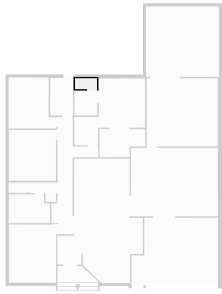

▼ **Hall**  
Ground Floor

WIDTH: 1.99 m • LENGTH: 2.36 m  
AREA: 4.17 m<sup>2</sup> • PERIMETER: 8.18 m

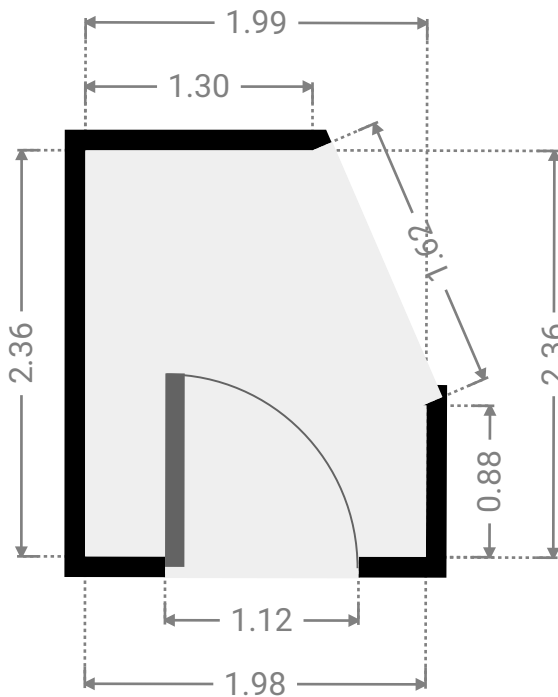
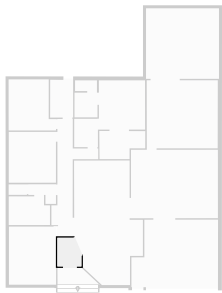



▼ **Master Bedroom**  
Ground Floor

WIDTH: 3.80 m • LENGTH: 4.05 m  
AREA: 15.39 m<sup>2</sup> • PERIMETER: 15.70 m

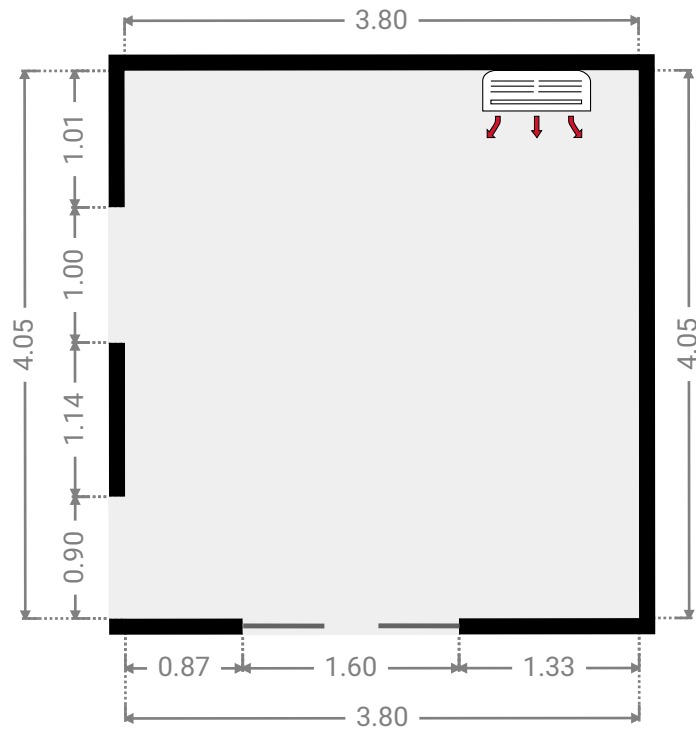
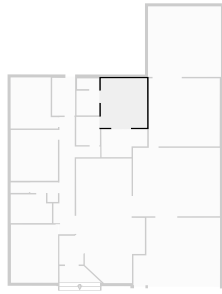

▼ **Hall**  
Ground Floor

WIDTH: 1.95 m • LENGTH: 2.33 m  
AREA: 4.54 m<sup>2</sup> • PERIMETER: 8.56 m

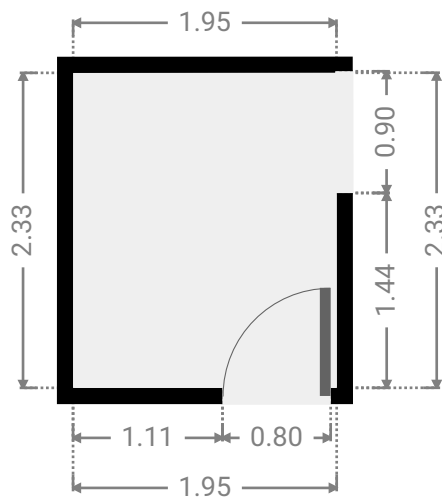
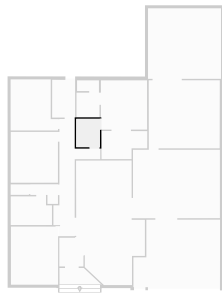

▼ **Hall**  
Ground Floor

WIDTH: 2.00 m • LENGTH: 0.88 m  
AREA: 1.76 m<sup>2</sup> • PERIMETER: 5.76 m

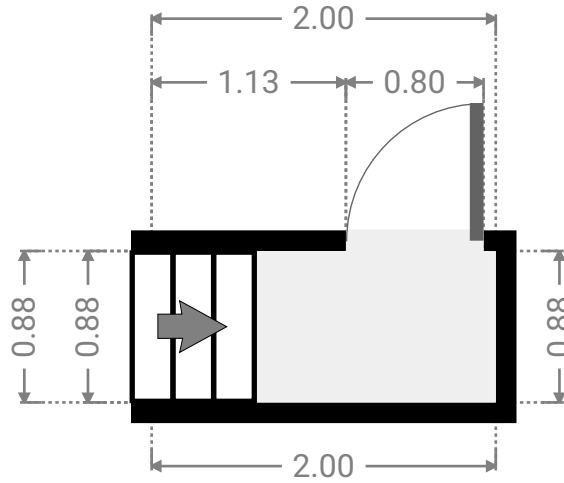
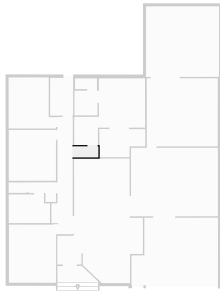

▼ **Bathroom**  
Ground Floor

WIDTH: 3.39 m • LENGTH: 2.36 m  
AREA: 7.63 m<sup>2</sup> • PERIMETER: 11.49 m

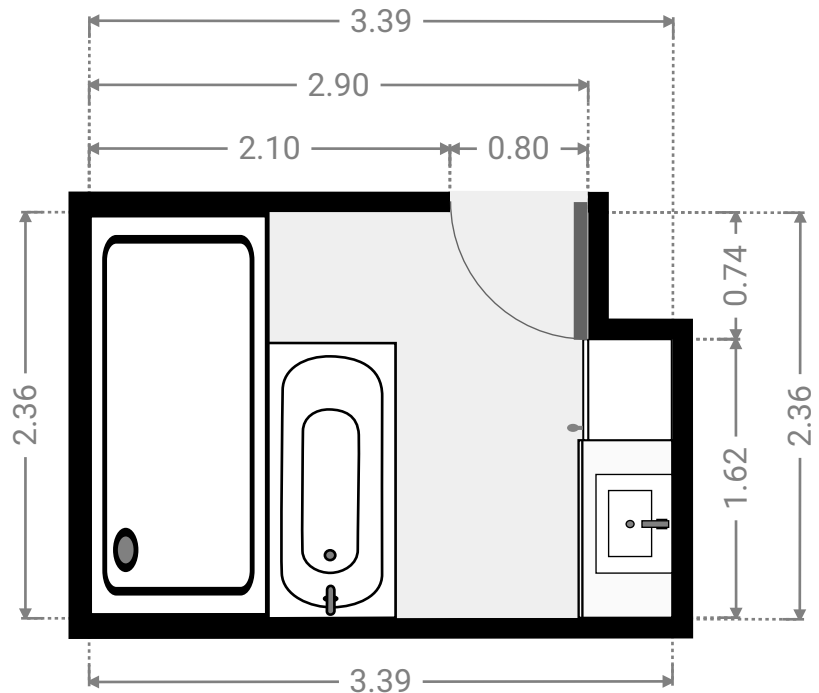
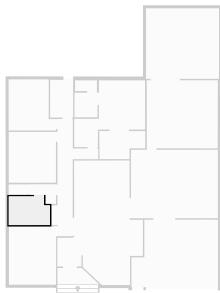

▼ Toilet  
Ground Floor

WIDTH: 1.50 m • LENGTH: 0.86 m  
AREA: 1.29 m<sup>2</sup> • PERIMETER: 4.72 m

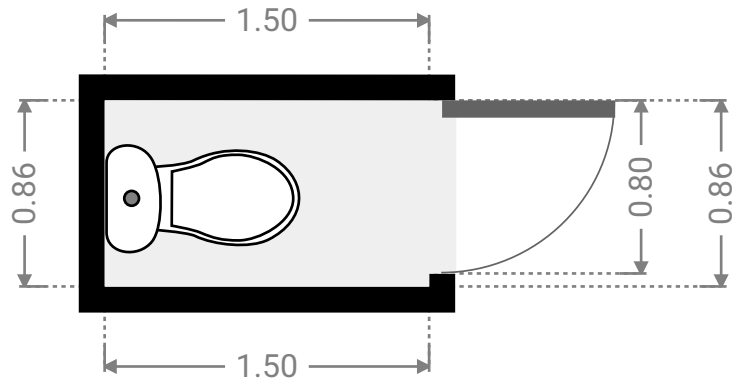
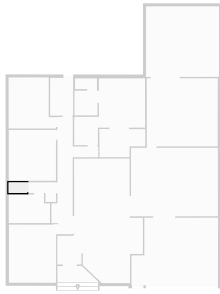

▼ Hall  
Ground Floor

WIDTH: 2.27 m • LENGTH: 1.61 m  
AREA: 2.63 m<sup>2</sup> • PERIMETER: 7.77 m

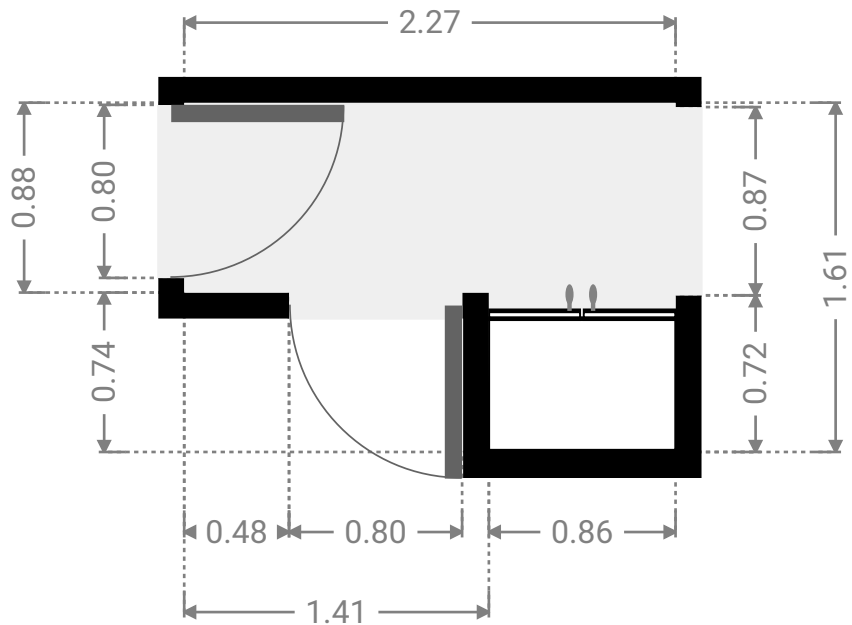
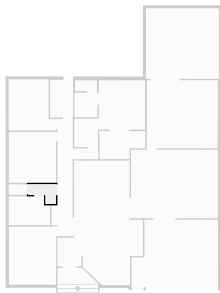

▼ **Bedroom**  
Ground Floor

WIDTH: 3.88 m • LENGTH: 4.78 m  
AREA: 18.55 m<sup>2</sup> • PERIMETER: 17.32 m

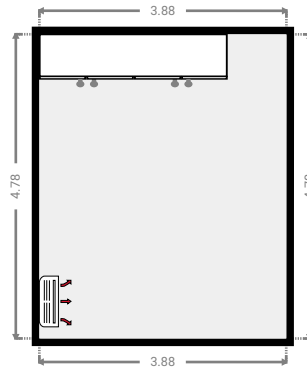
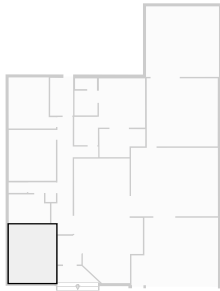

▼ **Hall**  
Ground Floor

WIDTH: 1.75 m • LENGTH: 9.64 m  
AREA: 12.88 m<sup>2</sup> • PERIMETER: 22.78 m

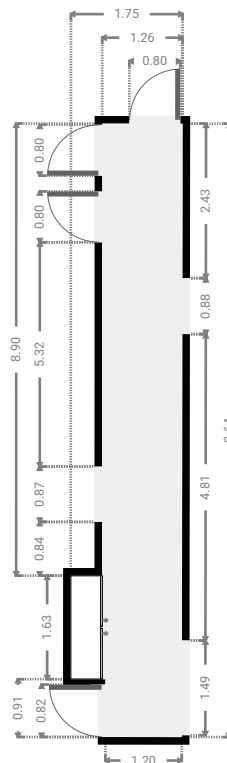
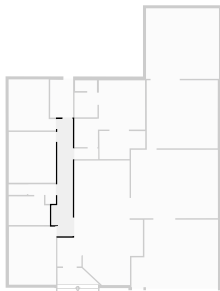

▼ **Living Room**  
Ground Floor

WIDTH: 5.67 m • LENGTH: 10.25 m  
AREA: 46.60 m<sup>2</sup> • PERIMETER: 30.35 m

