

17 Milford Avenue

Ground Floor

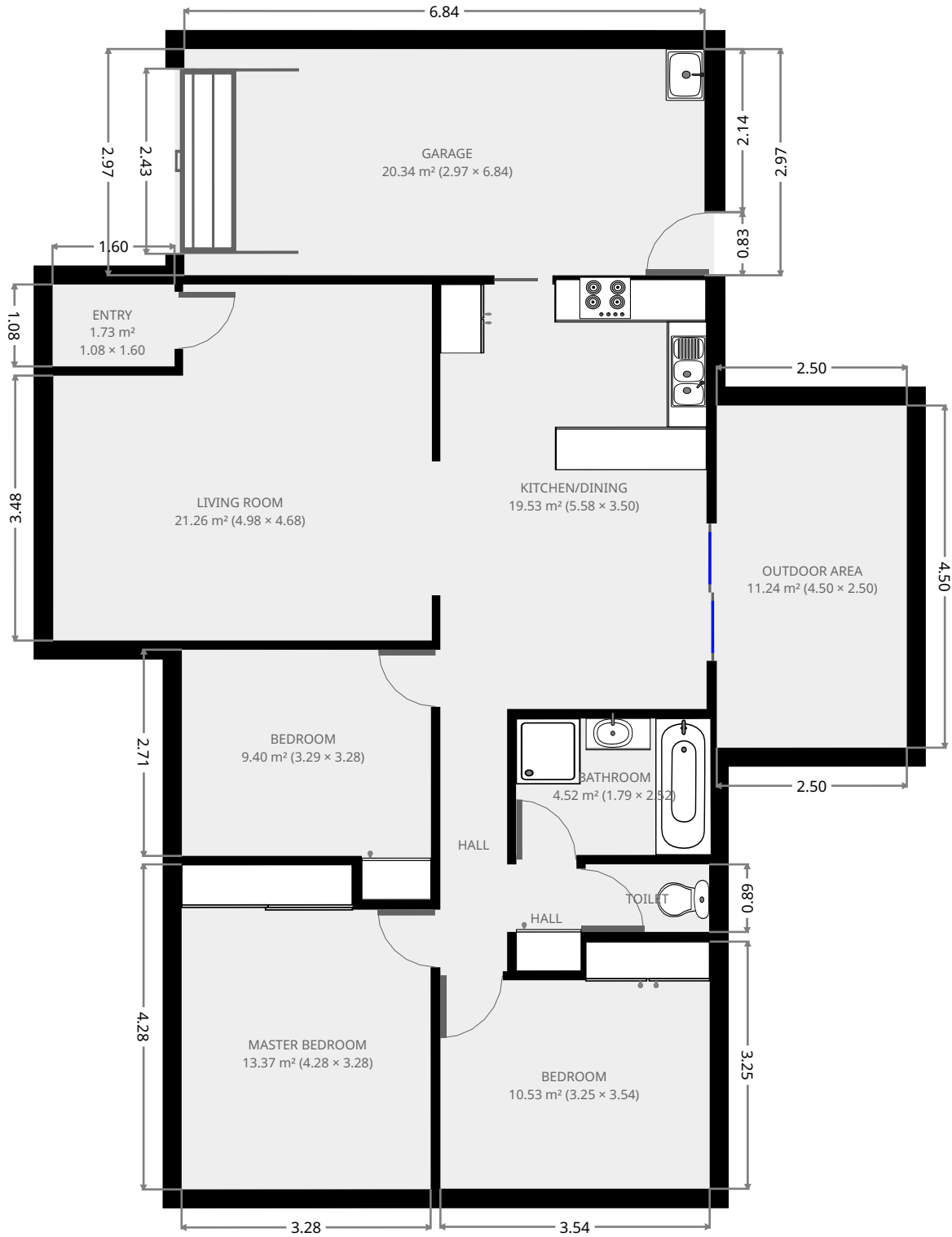

THIS FLOORPLAN IS PROVIDED WITHOUT WARRANTY OF ANY KIND. SENSOPIA DISCLAIMS ANY WARRANTY INCLUDING, WITHOUT LIMITATION, SATISFACTORY QUALITY OR ACCURACY OF DIMENSIONS.



17 Milford Avenue

Living Room

Width: 4.68 m
 Length: 4.98 m
 Area: 21.26 m²
 Perimeter: 19.32 m

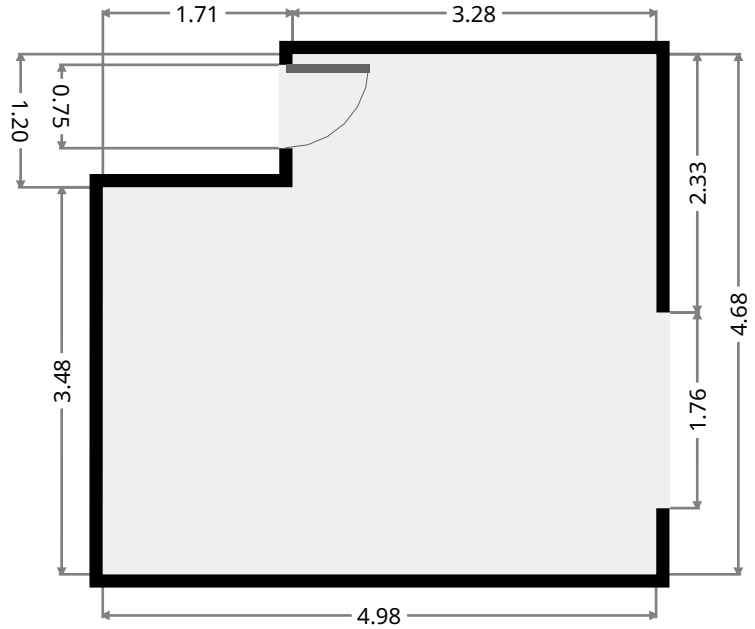
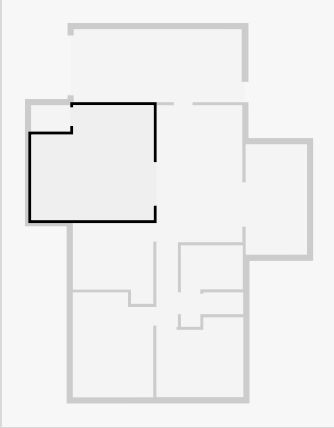

Kitchen/Dining

Width: 3.50 m
 Length: 5.58 m
 Area: 19.53 m²
 Perimeter: 18.16 m

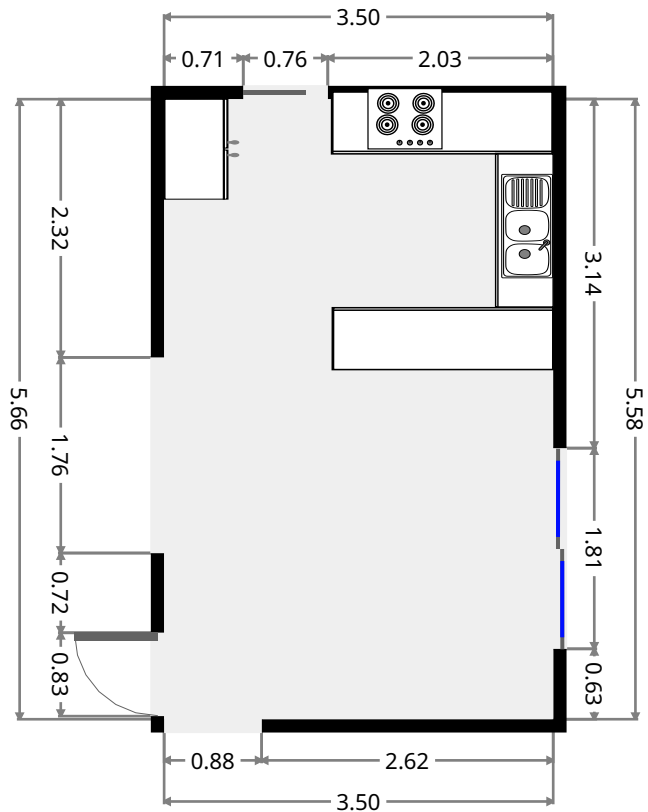
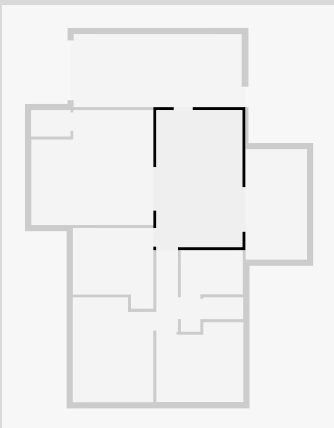

THIS FLOORPLAN IS PROVIDED WITHOUT WARRANTY OF ANY KIND. SENSOPIA DISCLAIMS ANY WARRANTY INCLUDING, WITHOUT LIMITATION, SATISFACTORY QUALITY OR ACCURACY OF DIMENSIONS.

17 Milford Avenue

Bedroom

Width: 3.28 m
 Length: 3.29 m
 Area: 9.40 m²
 Perimeter: 13.12 m

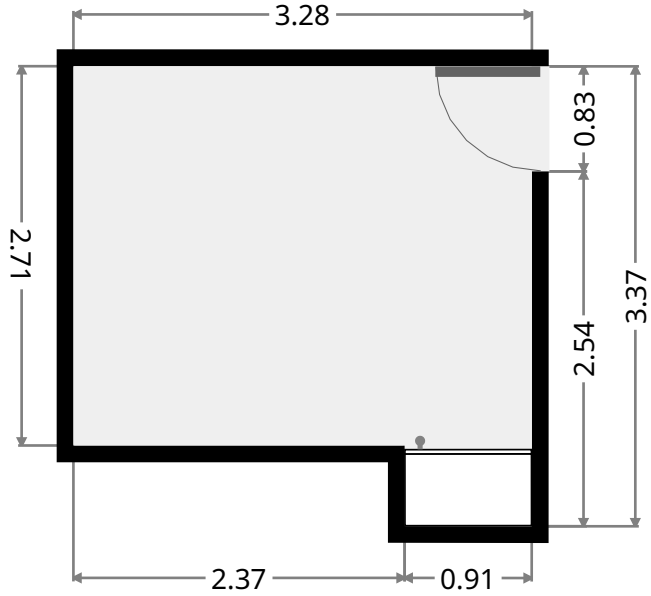
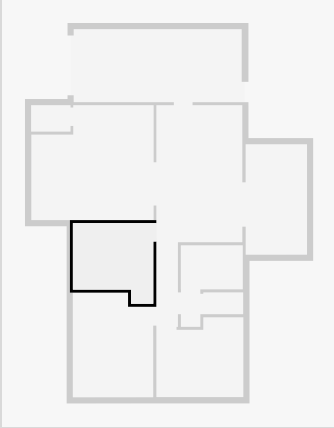

Hall

Width: 0.88 m
 Length: 3.32 m
 Area: 2.92 m²
 Perimeter: 8.40 m

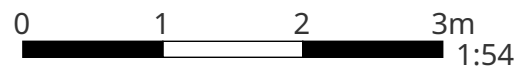
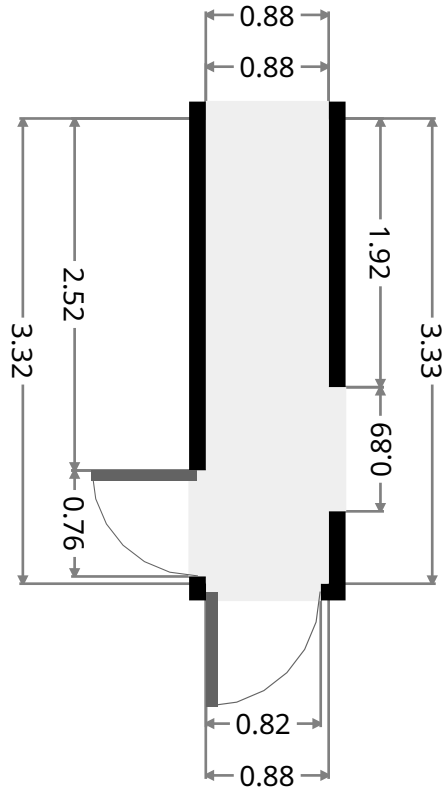
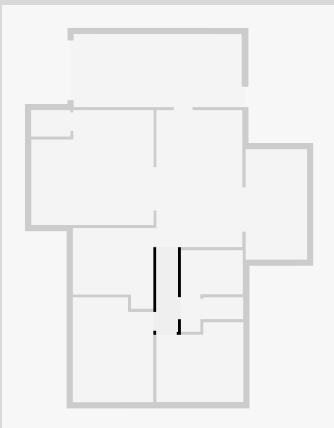

THIS FLOORPLAN IS PROVIDED WITHOUT WARRANTY OF ANY KIND. SENSOPIA DISCLAIMS ANY WARRANTY INCLUDING, WITHOUT LIMITATION, SATISFACTORY QUALITY OR ACCURACY OF DIMENSIONS.

17 Milford Avenue

Master Bedroom

Width: 3.28 m
 Length: 4.28 m
 Area: 13.37 m²
 Perimeter: 15.09 m

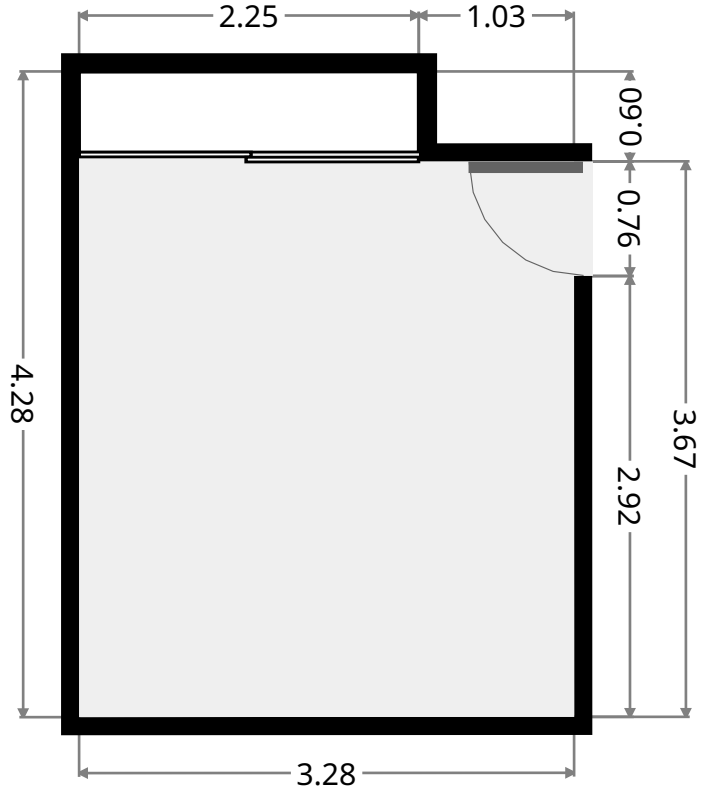
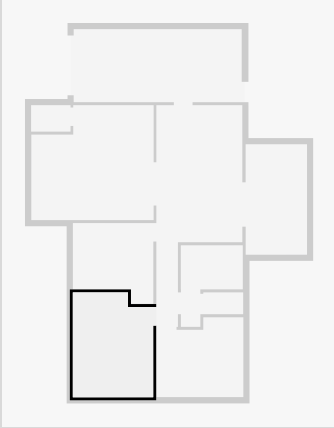

Bedroom

Width: 3.25 m
 Length: 3.54 m
 Area: 10.53 m²
 Perimeter: 13.58 m

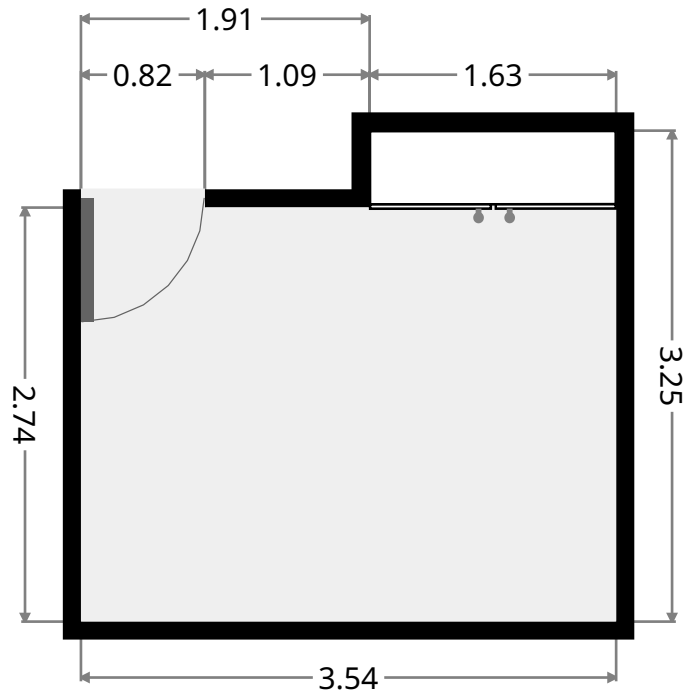
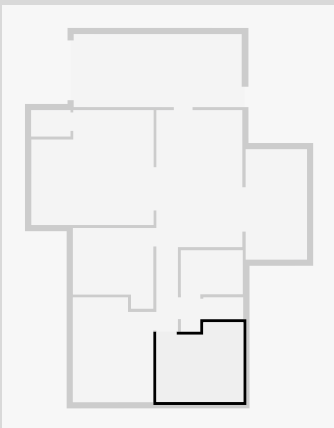

17 Milford Avenue

Bathroom

Width: 1.79 m
 Length: 2.52 m
 Area: 4.52 m²
 Perimeter: 8.63 m

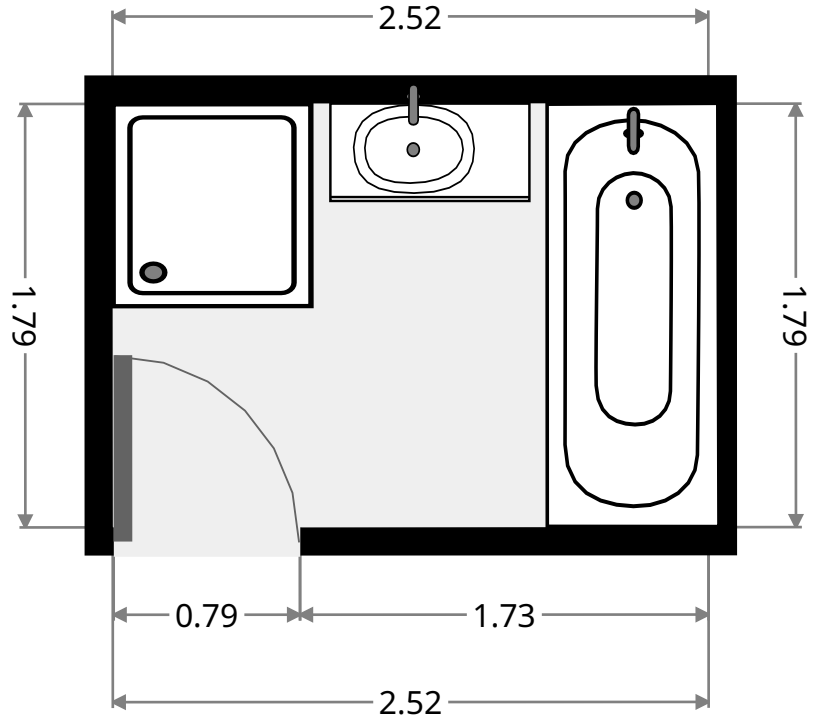
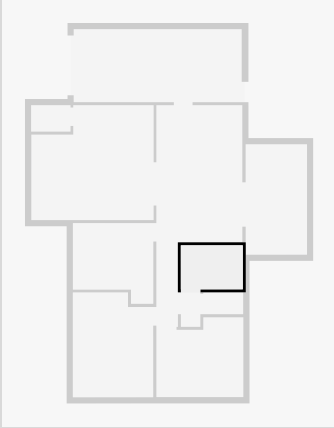

Toilet

Width: 0.89 m
 Length: 1.63 m
 Area: 1.44 m²
 Perimeter: 5.02 m

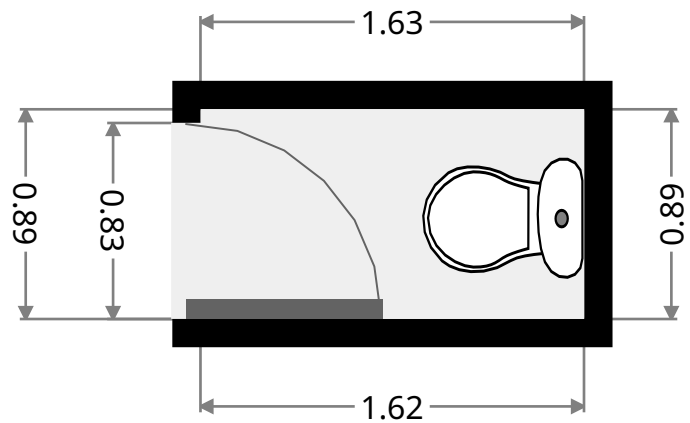
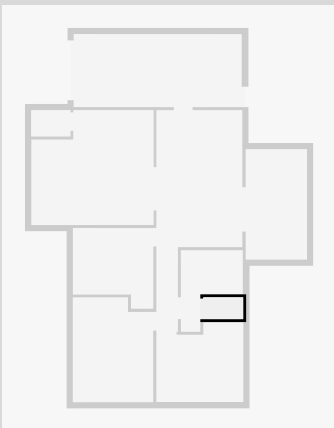

17 Milford Avenue

Hall

Width: 0.79 m
 Length: 1.41 m
 Area: 1.11 m²
 Perimeter: 4.39 m

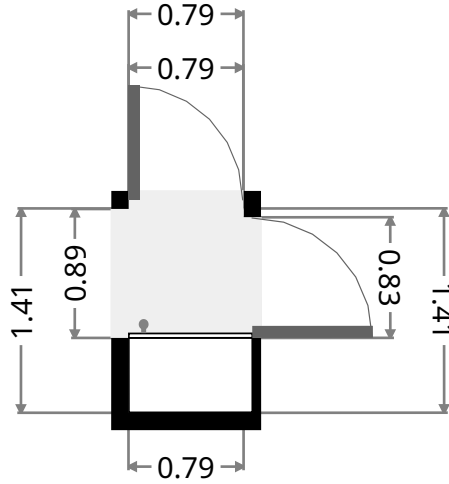
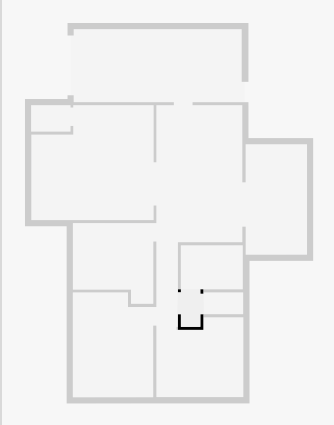

Outdoor Area

Width: 2.50 m
 Length: 4.50 m
 Area: 11.24 m²
 Perimeter: 13.99 m

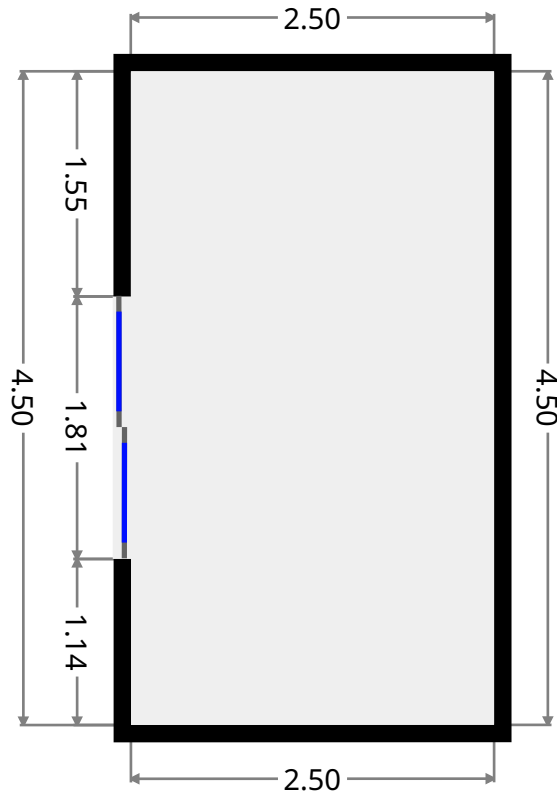
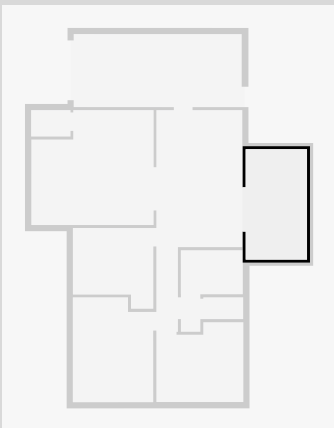

17 Milford Avenue

Garage

Width: 2.97 m
Length: 6.84 m
Area: 20.34 m²
Perimeter: 19.63 m

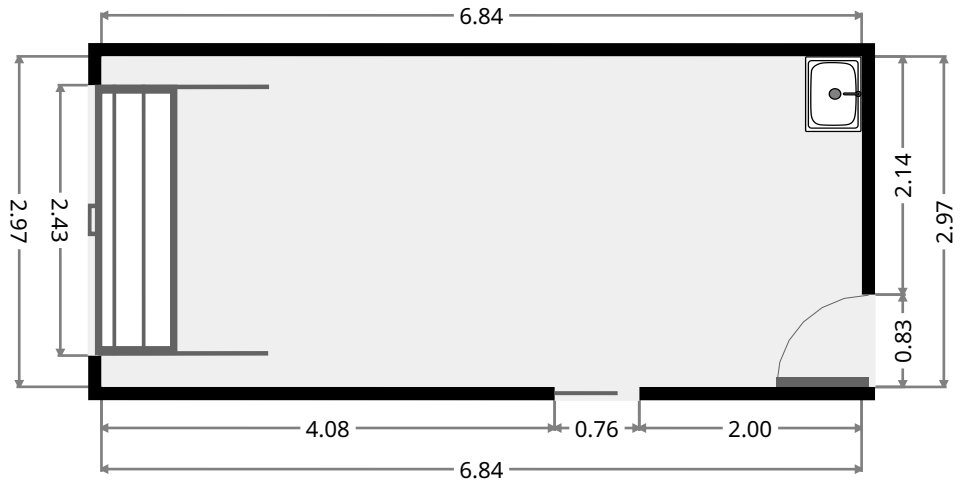
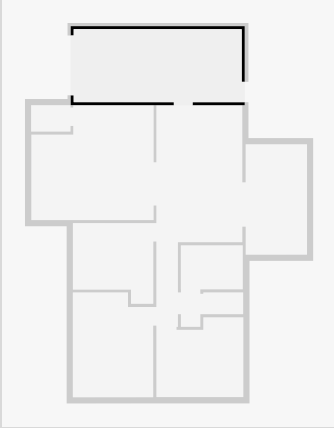

Entry

Width: 1.08 m
Length: 1.60 m
Area: 1.73 m²
Perimeter: 5.36 m

