

160 Guymer Street

Ground Floor



THIS FLOORPLAN IS PROVIDED WITHOUT WARRANTY OF ANY KIND. SENSOPIA DISCLAIMS ANY WARRANTY INCLUDING, WITHOUT LIMITATION, SATISFACTORY QUALITY OR ACCURACY OF DIMENSIONS.



160 Guymer Street

Hall

Width: 2.51 m
 Length: 3.59 m
 Area: 6.21 m²
 Perimeter: 12.21 m

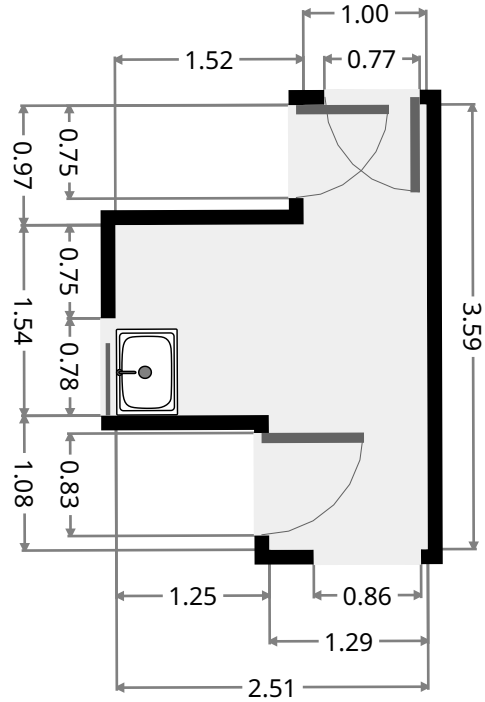
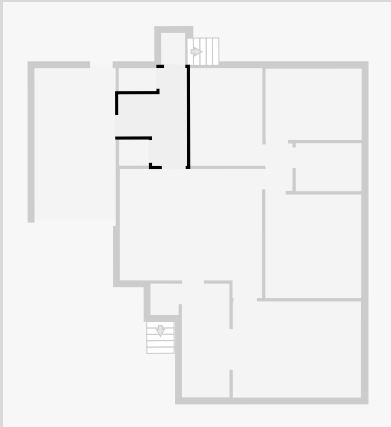

Kitchen/Dining

Width: 4.75 m
 Length: 5.21 m
 Area: 22.10 m²
 Perimeter: 19.95 m

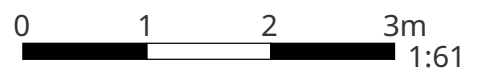
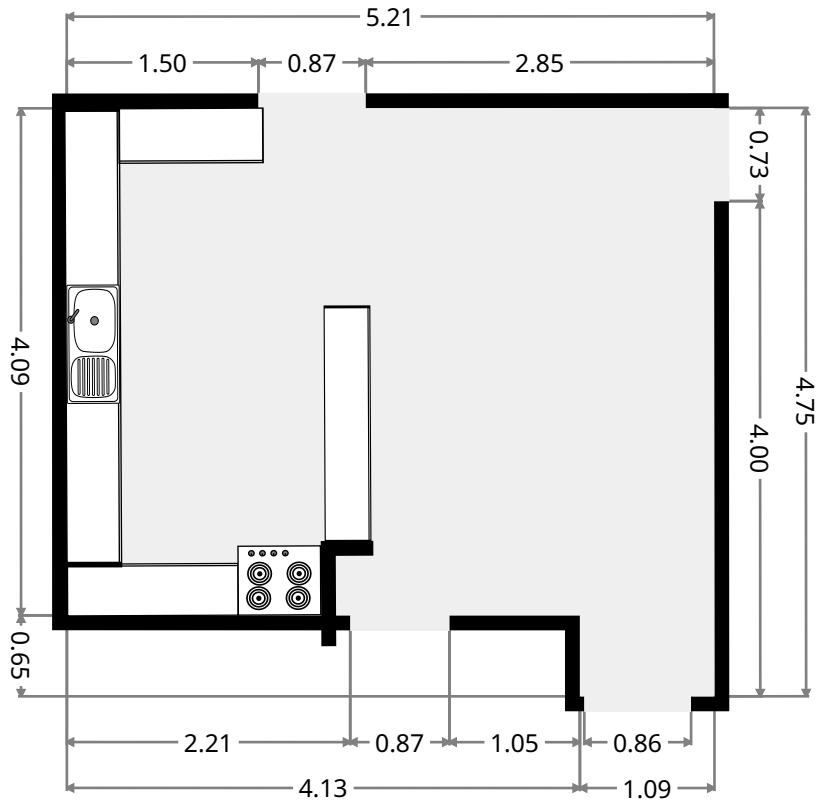
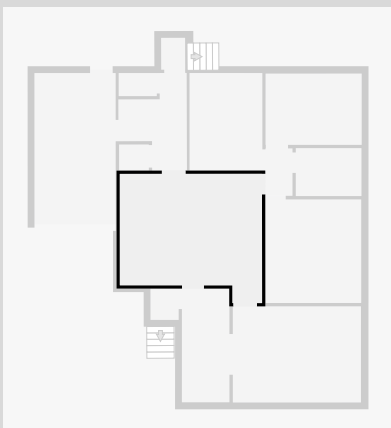

THIS FLOORPLAN IS PROVIDED WITHOUT WARRANTY OF ANY KIND. SENSOPIA DISCLAIMS ANY WARRANTY INCLUDING, WITHOUT LIMITATION, SATISFACTORY QUALITY OR ACCURACY OF DIMENSIONS.

160 Guymer Street

Hall

Width: 0.99 m
Length: 1.74 m
Area: 1.73 m²
Perimeter: 5.47 m

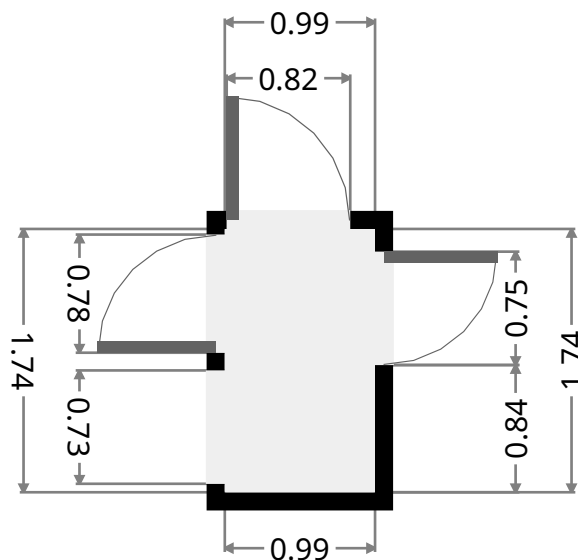
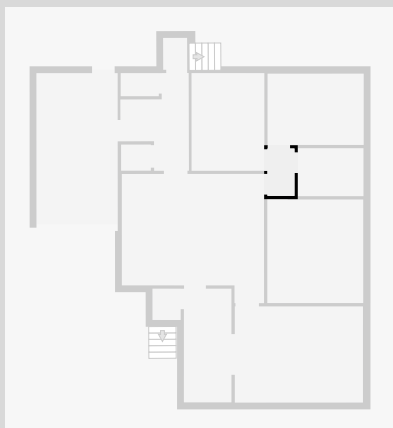

Bedroom

Width: 3.52 m
Length: 3.80 m
Area: 13.41 m²
Perimeter: 14.66 m

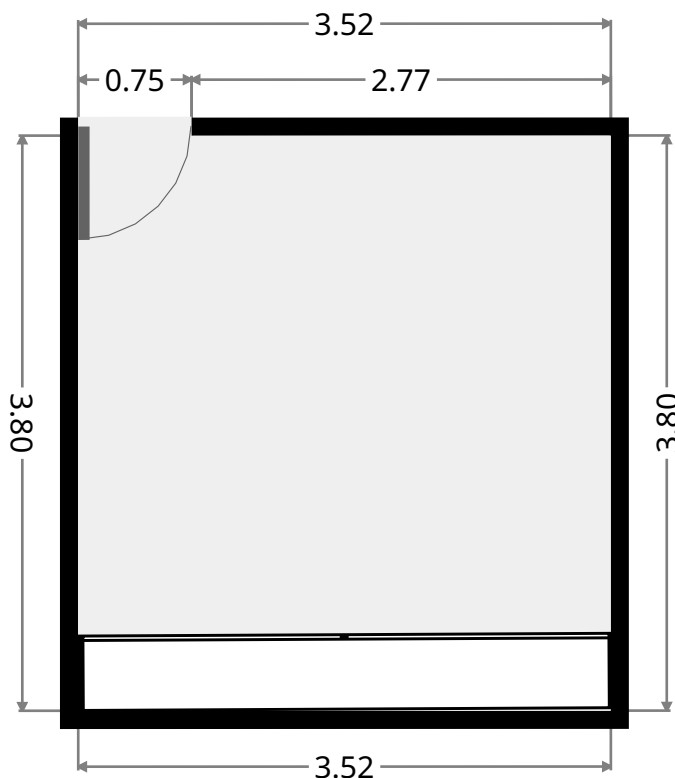
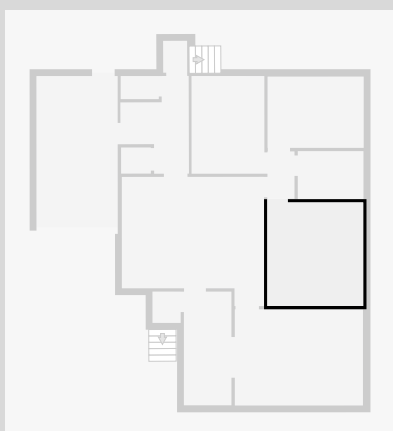

160 Guymer Street

Bathroom

Width: 1.76 m
Length: 2.42 m
Area: 4.25 m²
Perimeter: 8.35 m

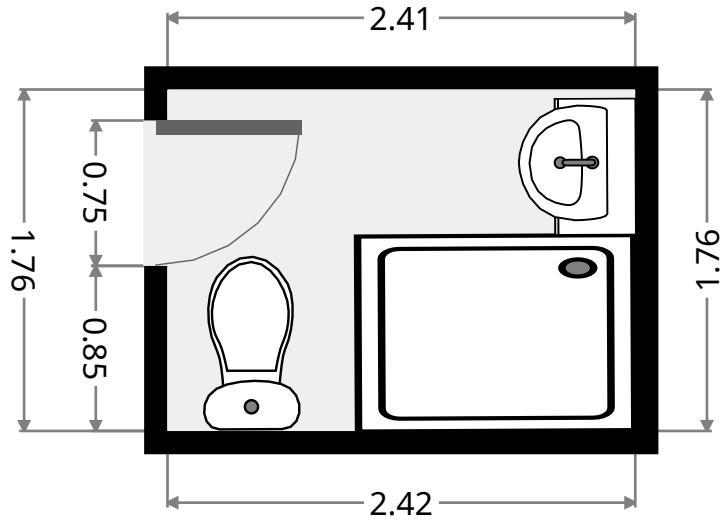
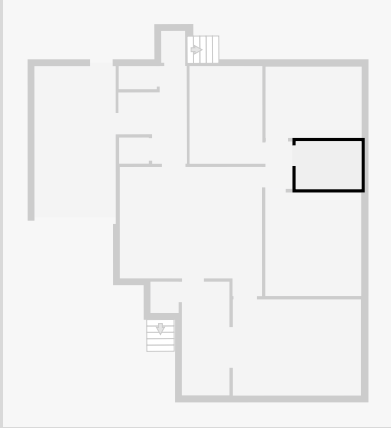

Bedroom

Width: 2.62 m
Length: 3.53 m
Area: 9.25 m²
Perimeter: 12.31 m

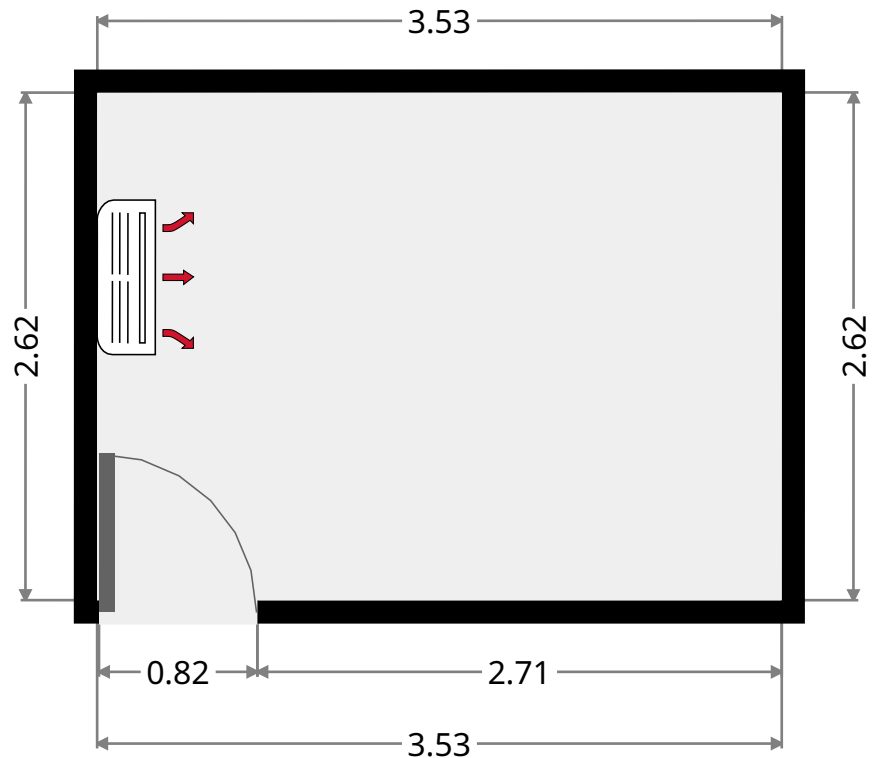
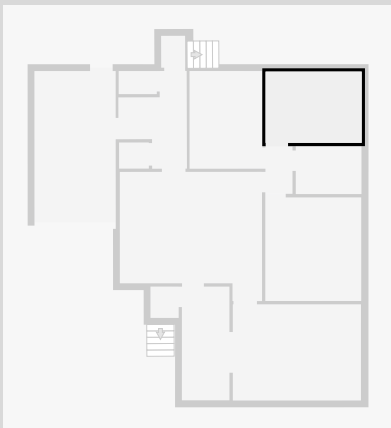

160 Guymer Street

Bedroom

Width: 2.68 m
 Length: 3.59 m
 Area: 9.60 m²
 Perimeter: 12.53 m

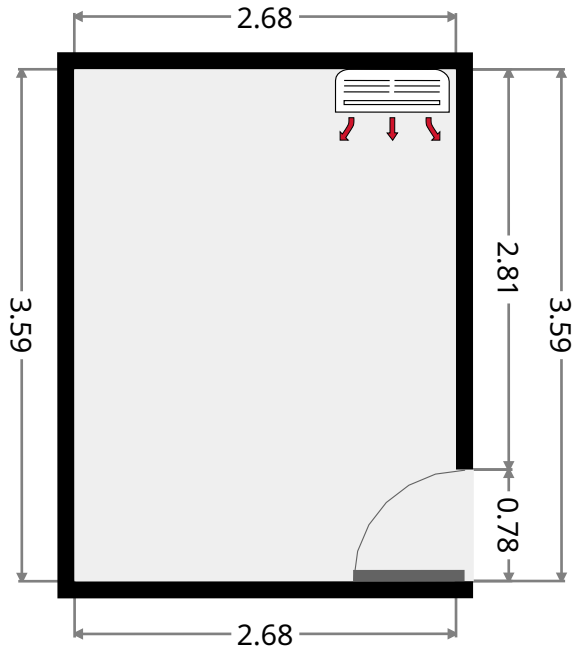
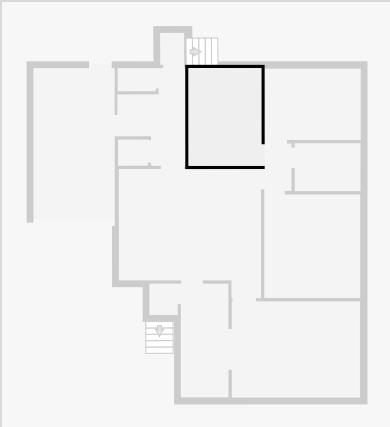

Sunroom

Width: 1.75 m
 Length: 4.18 m
 Area: 7.30 m²
 Perimeter: 11.85 m

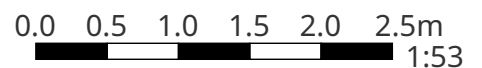
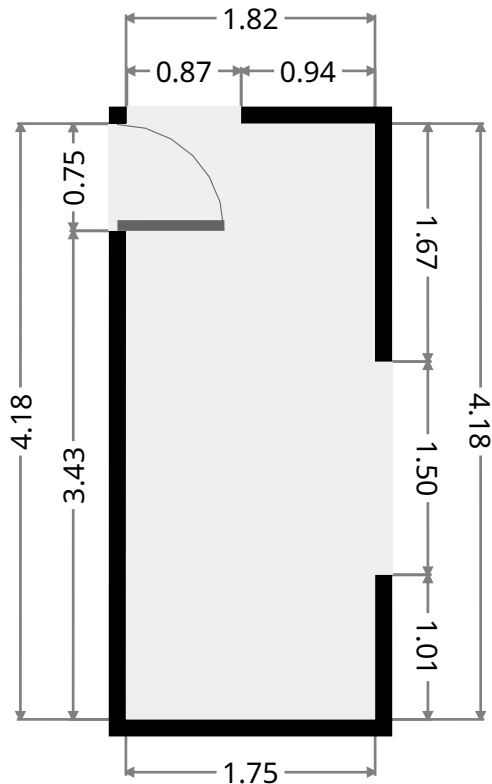
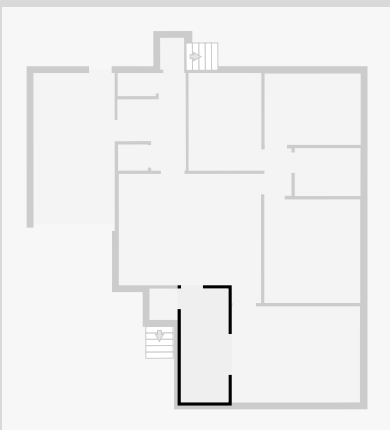

THIS FLOORPLAN IS PROVIDED WITHOUT WARRANTY OF ANY KIND. SENSOPIA DISCLAIMS ANY WARRANTY INCLUDING, WITHOUT LIMITATION, SATISFACTORY QUALITY OR ACCURACY OF DIMENSIONS.

160 Guymer Street

Living Room

Width: 3.53 m
Length: 4.71 m
Area: 16.64 m²
Perimeter: 16.49 m

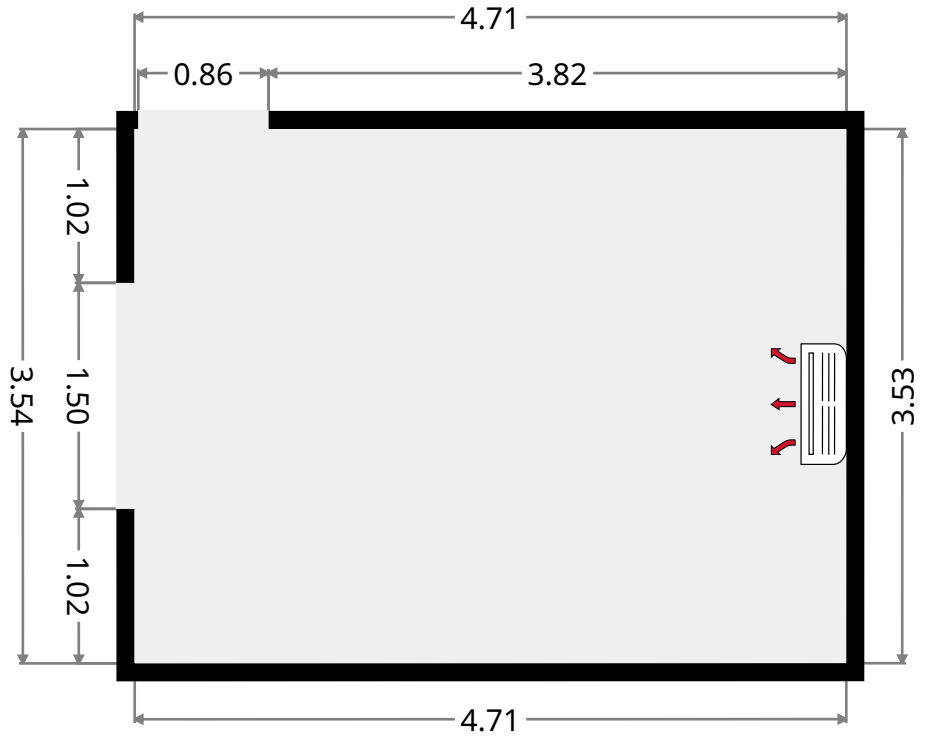

Hall

Width: 0.87 m
Length: 1.17 m
Area: 1.03 m²
Perimeter: 4.10 m

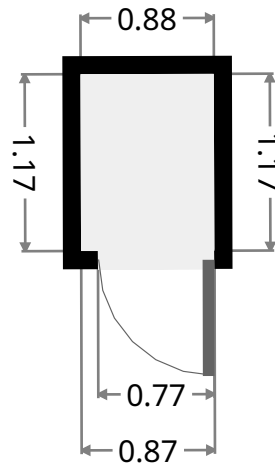
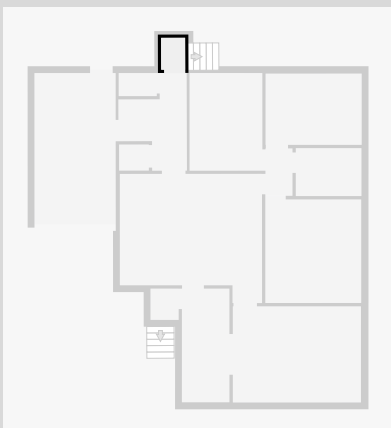

160 Guymer Street

Stairway

Width: 0.96 m
Length: 1.09 m
Area: 1.05 m²
Perimeter: 4.11 m

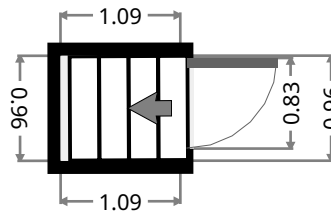

Garage

Width: 2.99 m
Length: 5.43 m
Area: 16.21 m²
Perimeter: 16.83 m

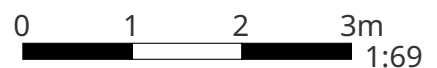
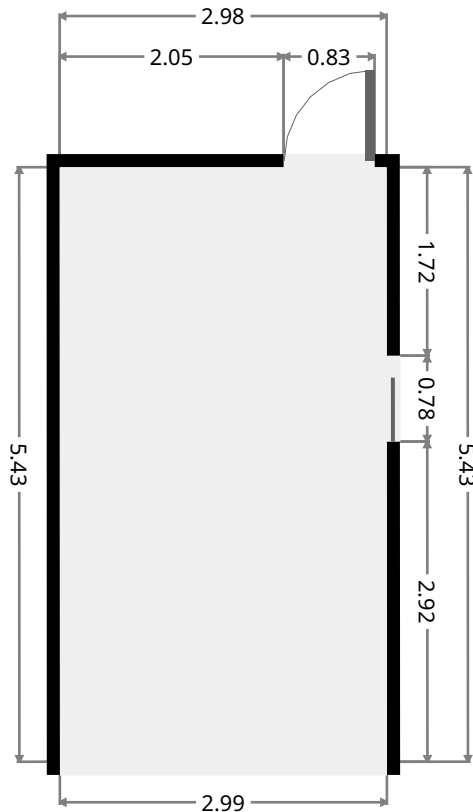
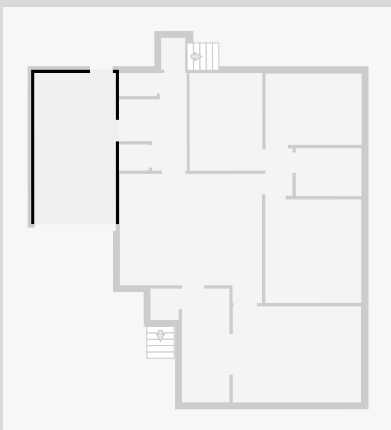

THIS FLOORPLAN IS PROVIDED WITHOUT WARRANTY OF ANY KIND. SENSOPIA DISCLAIMS ANY WARRANTY INCLUDING, WITHOUT LIMITATION, SATISFACTORY QUALITY OR ACCURACY OF DIMENSIONS.

160 Guymer Street

Hall

Width: 1.04 m
Length: 1.15 m
Area: 1.19 m²
Perimeter: 4.37 m

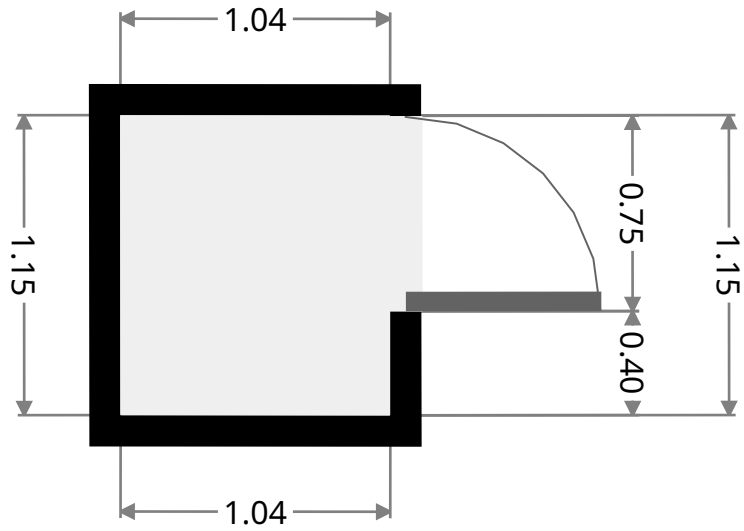
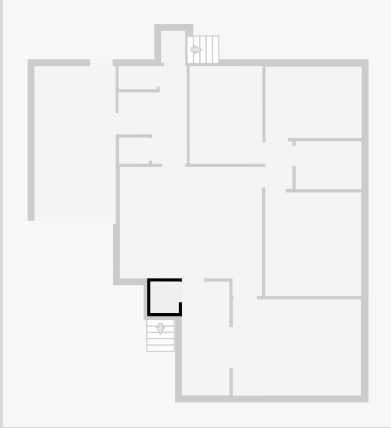

Toilet

Width: 0.85 m
Length: 1.40 m
Area: 1.19 m²
Perimeter: 4.50 m

