

13 Standish Street

Ground Floor

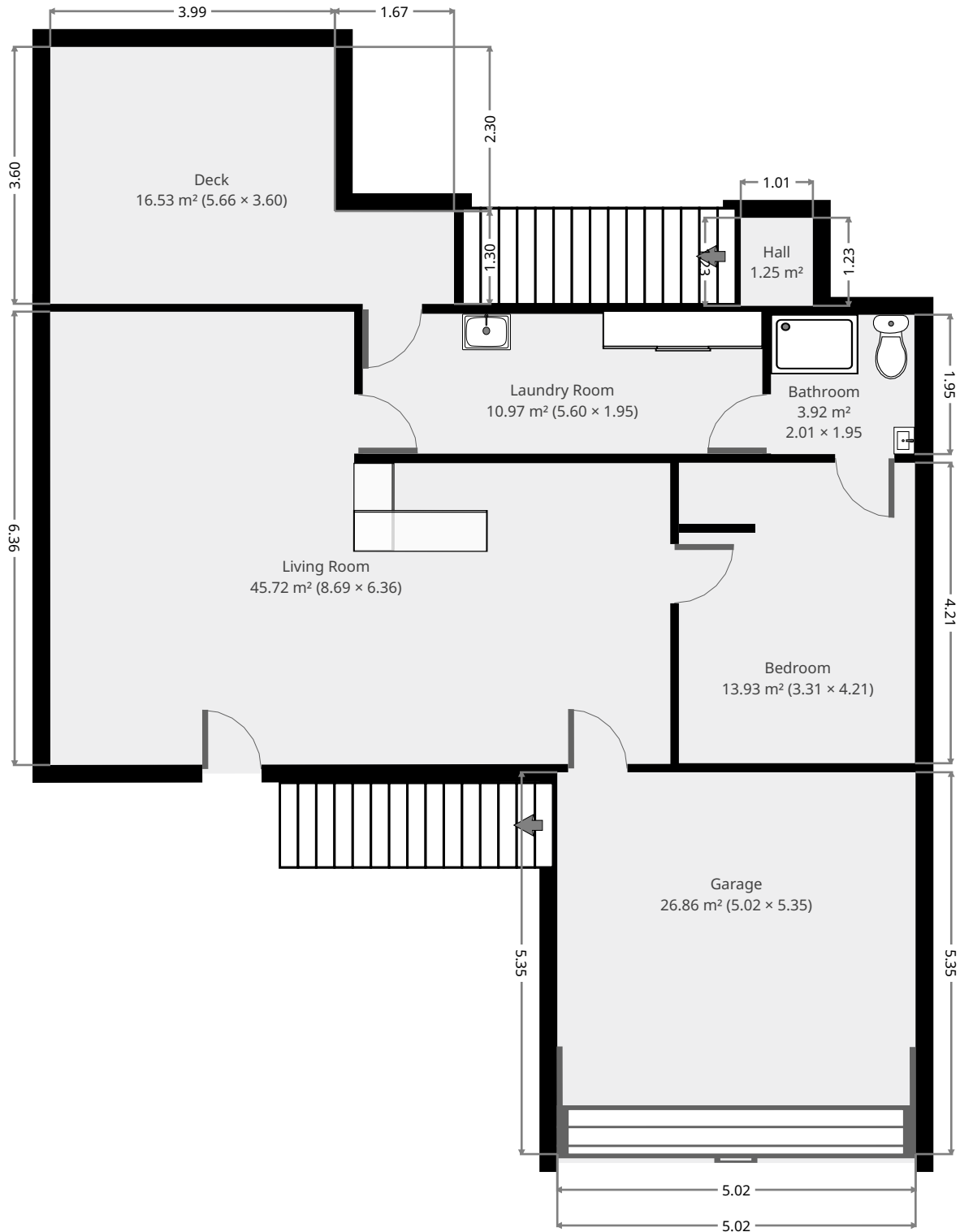

THIS FLOORPLAN IS PROVIDED WITHOUT WARRANTY OF ANY KIND. SENSOPIA DISCLAIMS ANY WARRANTY INCLUDING, WITHOUT LIMITATION, SATISFACTORY QUALITY OR ACCURACY OF DIMENSIONS.



13 Standish Street

Living Room

Width: 6.36 m
 Length: 8.69 m
 Area: 45.72 m²
 Perimeter: 30.07 m

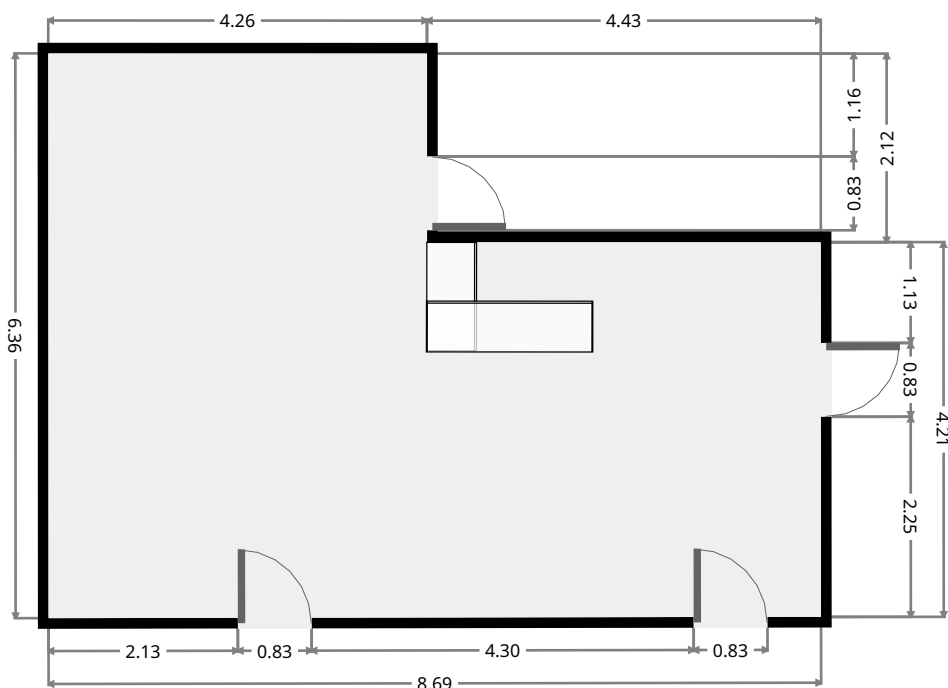
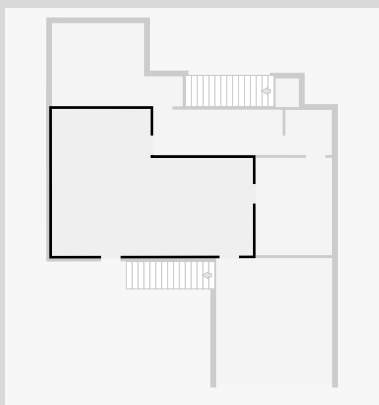

Bedroom

Width: 3.31 m
 Length: 4.21 m
 Area: 13.93 m²
 Perimeter: 15.04 m

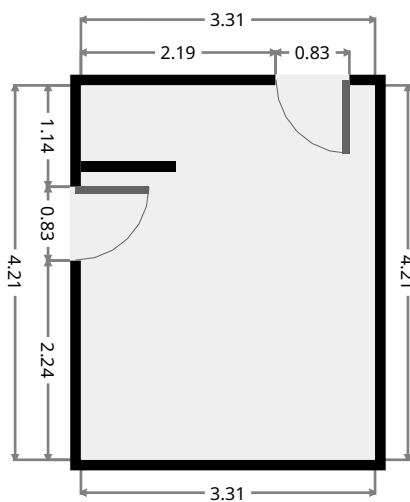
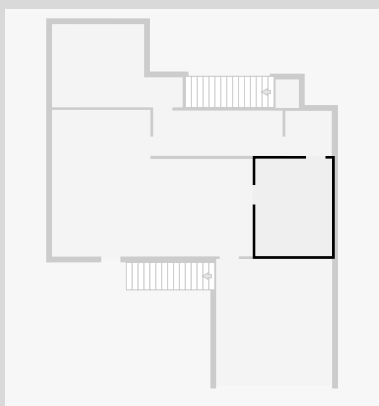

THIS FLOORPLAN IS PROVIDED WITHOUT WARRANTY OF ANY KIND. SENSOPIA DISCLAIMS ANY WARRANTY INCLUDING, WITHOUT LIMITATION, SATISFACTORY QUALITY OR ACCURACY OF DIMENSIONS.

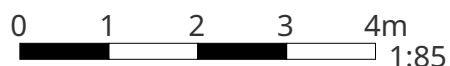

13 Standish Street

Bathroom

Width: 1.95 m
 Length: 2.01 m
 Area: 3.92 m²
 Perimeter: 7.93 m

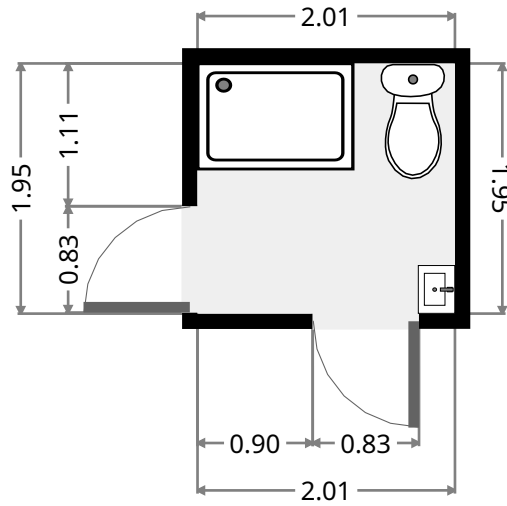
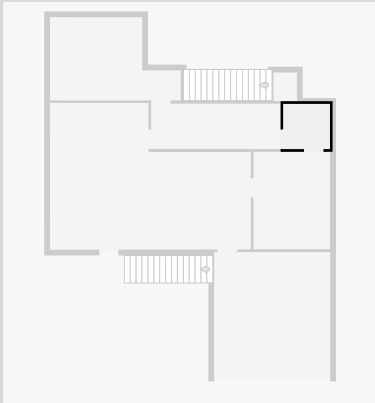

Laundry Room

Width: 1.95 m
 Length: 5.60 m
 Area: 10.97 m²
 Perimeter: 15.12 m

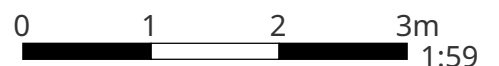
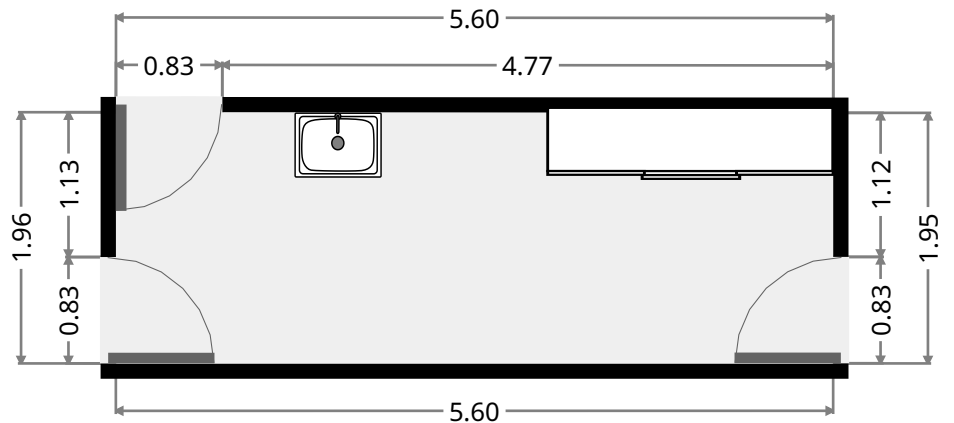
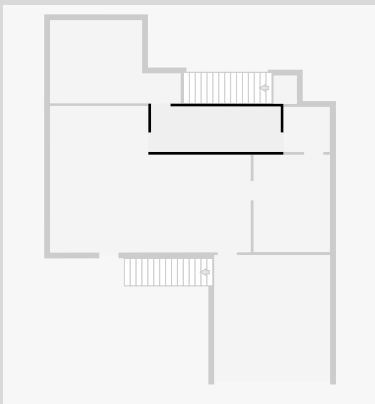

13 Standish Street

Garage

Width: 5.02 m
 Length: 5.35 m
 Area: 26.86 m²
 Perimeter: 20.74 m

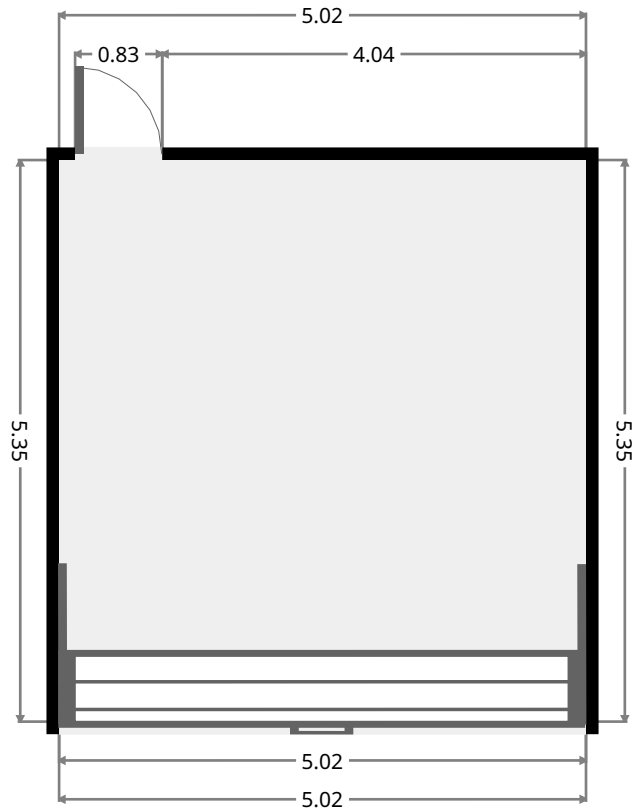
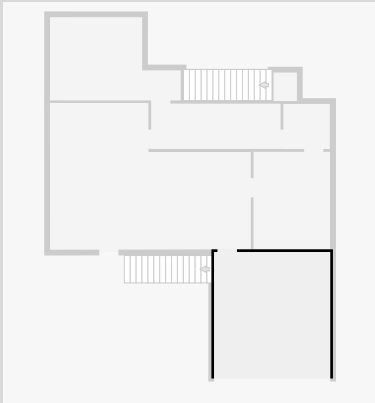

Deck

Width: 3.60 m
 Length: 5.66 m
 Area: 16.53 m²
 Perimeter: 18.52 m

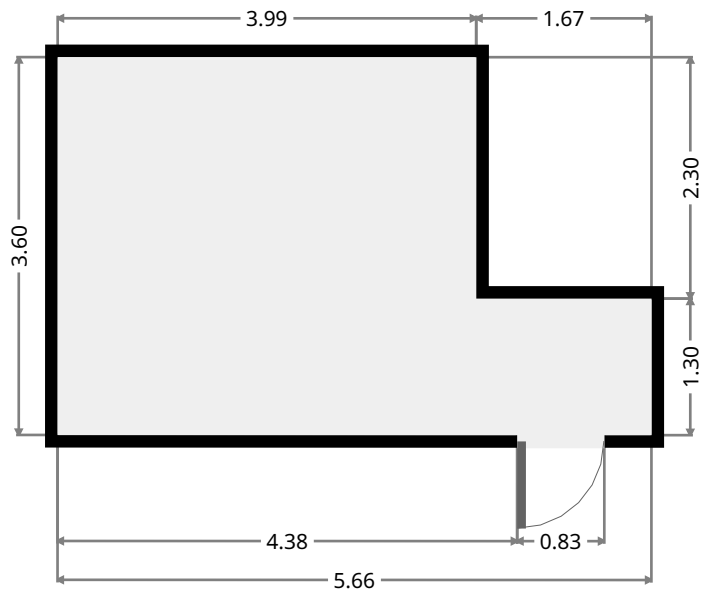
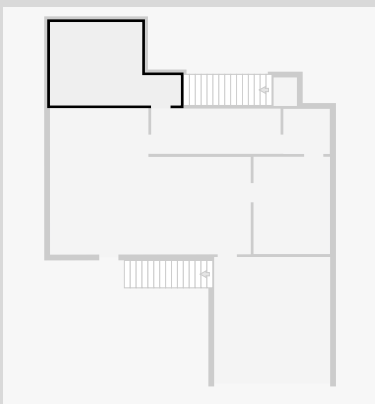

THIS FLOORPLAN IS PROVIDED WITHOUT WARRANTY OF ANY KIND. SENSOPIA DISCLAIMS ANY WARRANTY INCLUDING, WITHOUT LIMITATION, SATISFACTORY QUALITY OR ACCURACY OF DIMENSIONS.

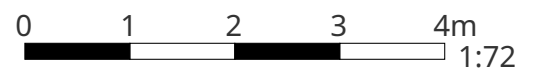

13 Standish Street

Hall

Width: 1.01 m
Length: 1.23 m
Area: 1.25 m²
Perimeter: 4.49 m

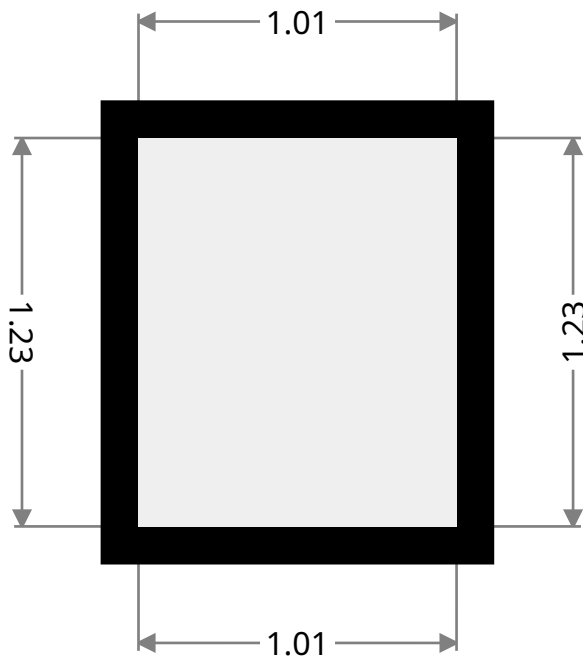
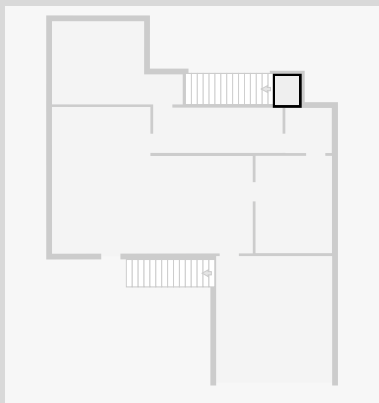

13 Standish Street

1st Floor



THIS FLOORPLAN IS PROVIDED WITHOUT WARRANTY OF ANY KIND. SENSOPIA DISCLAIMS ANY WARRANTY INCLUDING, WITHOUT LIMITATION, SATISFACTORY QUALITY OR ACCURACY OF DIMENSIONS.

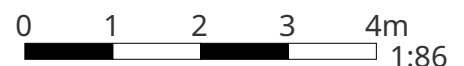

13 Standish Street

Living/Dining

Width: 5.24 m
 Length: 9.52 m
 Area: 40.18 m²
 Perimeter: 29.49 m

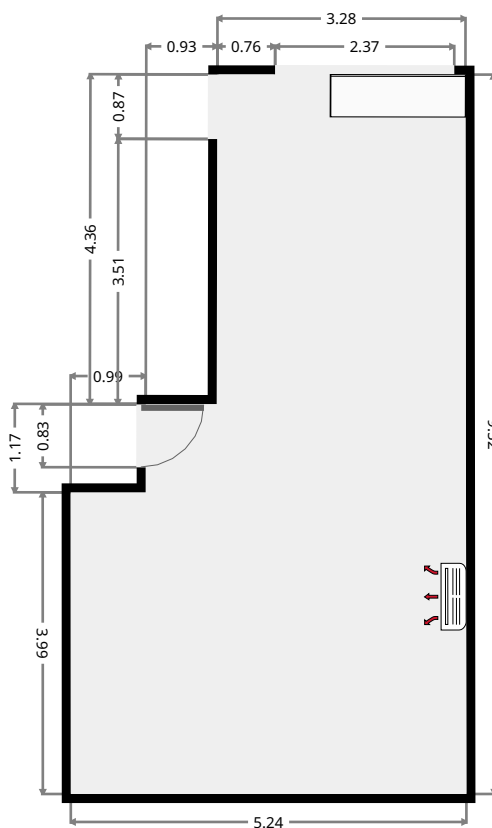
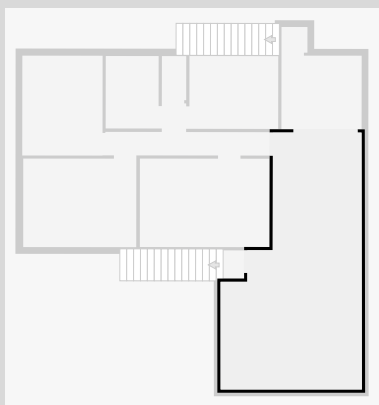

Kitchen

Width: 2.74 m
 Length: 2.97 m
 Area: 8.13 m²
 Perimeter: 11.42 m

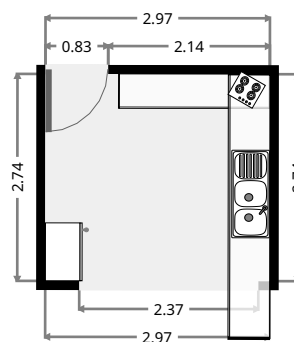
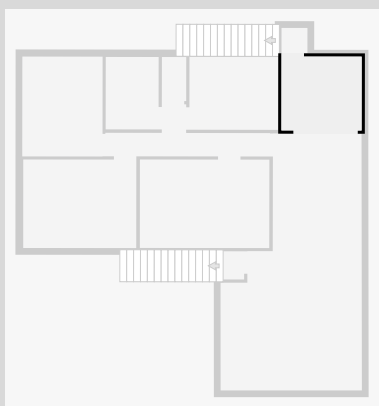

13 Standish Street

Hall

Width: 1.93 m
 Length: 6.11 m
 Area: 6.25 m²
 Perimeter: 16.06 m

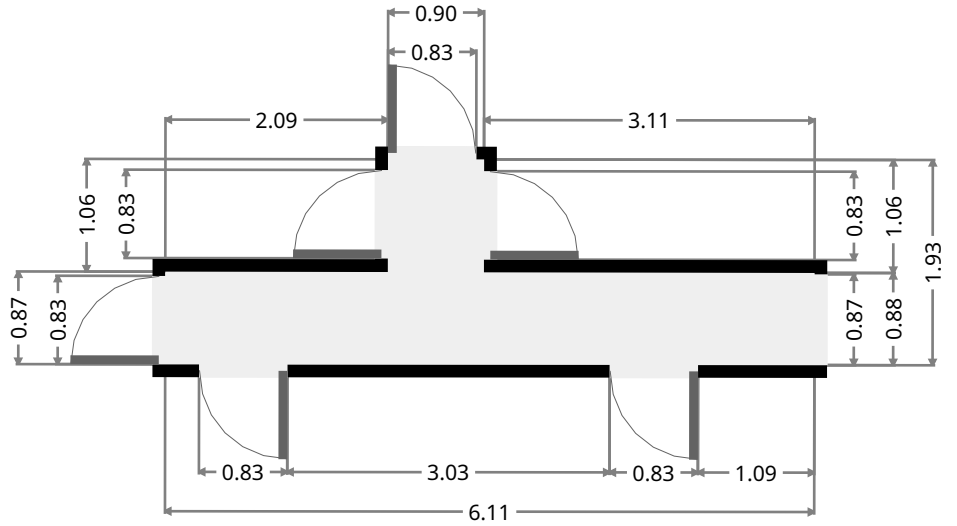
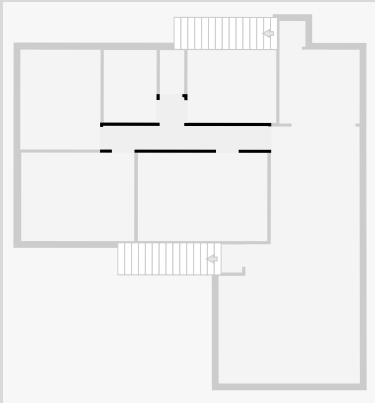

Bedroom

Width: 3.28 m
 Length: 4.79 m
 Area: 15.72 m²
 Perimeter: 16.15 m

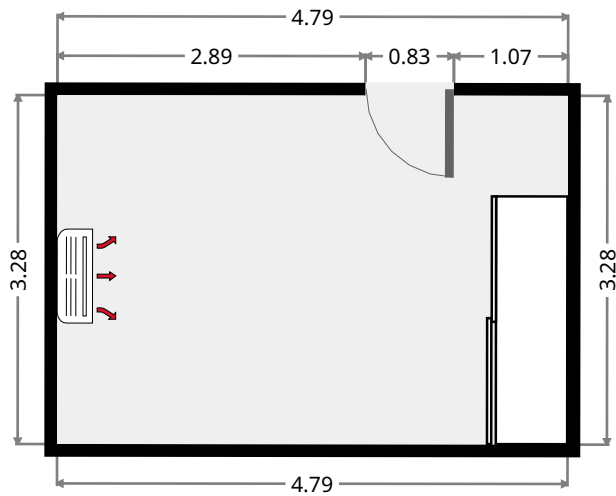
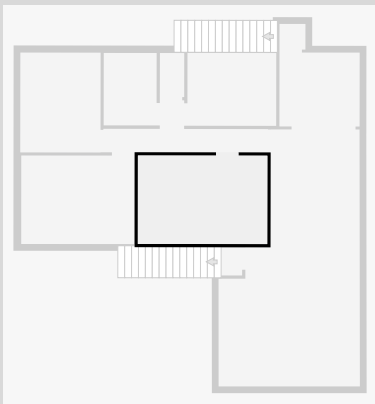

THIS FLOORPLAN IS PROVIDED WITHOUT WARRANTY OF ANY KIND. SENSOPIA DISCLAIMS ANY WARRANTY INCLUDING, WITHOUT LIMITATION, SATISFACTORY QUALITY OR ACCURACY OF DIMENSIONS.



13 Standish Street

Bedroom

Width: 3.28 m
 Length: 4.18 m
 Area: 13.73 m²
 Perimeter: 14.93 m

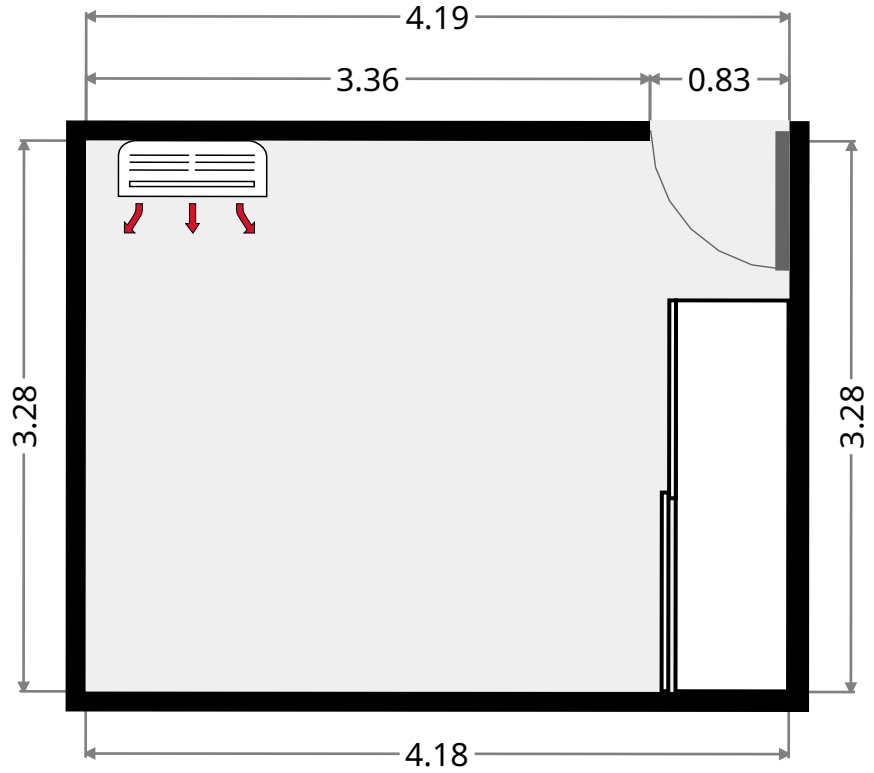
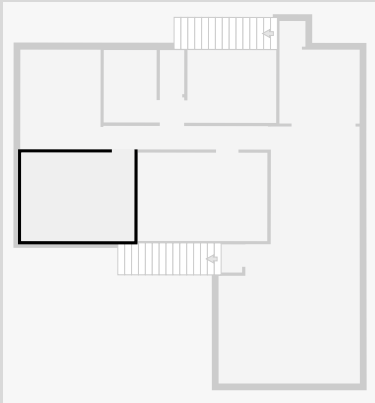

Bedroom

Width: 2.98 m
 Length: 3.70 m
 Area: 11.00 m²
 Perimeter: 13.34 m

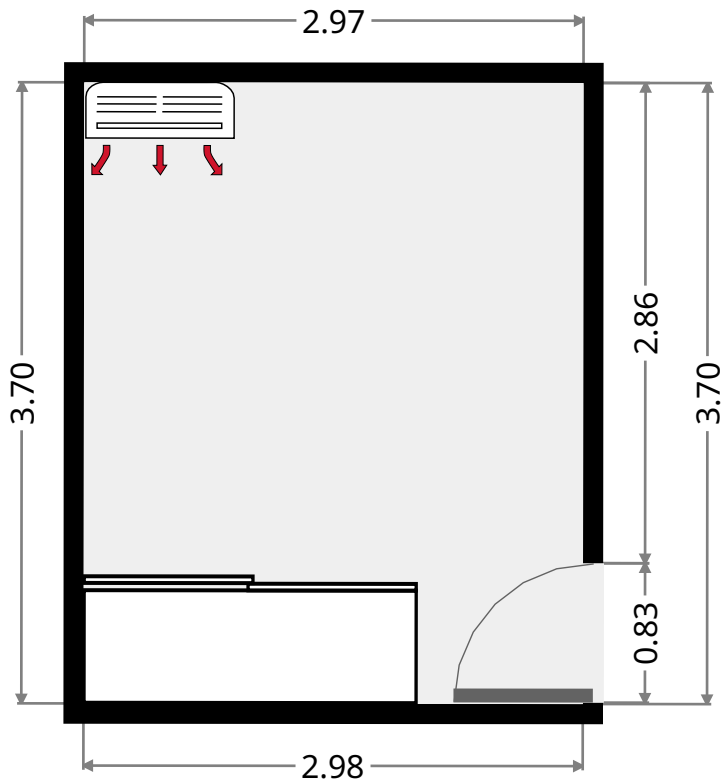
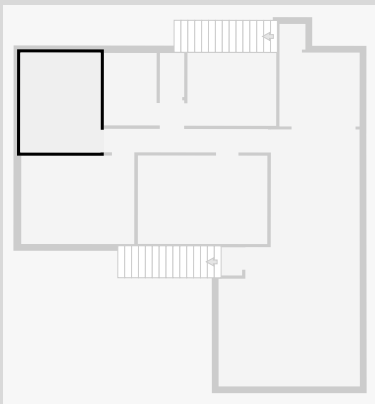

THIS FLOORPLAN IS PROVIDED WITHOUT WARRANTY OF ANY KIND. SENSOPIA DISCLAIMS ANY WARRANTY INCLUDING, WITHOUT LIMITATION, SATISFACTORY QUALITY OR ACCURACY OF DIMENSIONS.

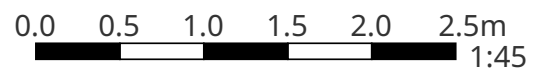

13 Standish Street

Bathroom

Width: 1.96 m
 Length: 2.68 m
 Area: 5.26 m²
 Perimeter: 9.29 m

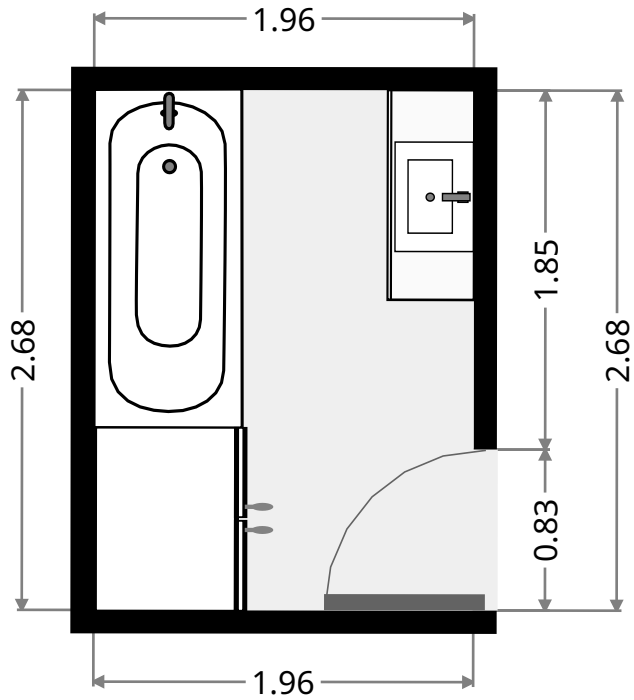
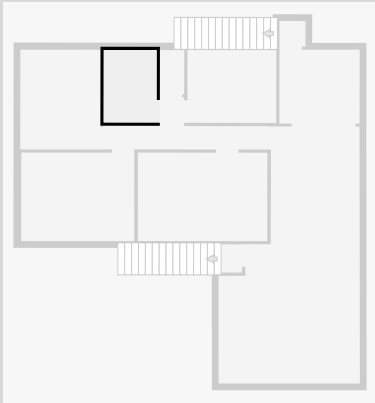

Bedroom

Width: 2.70 m
 Length: 3.29 m
 Area: 8.87 m²
 Perimeter: 11.97 m

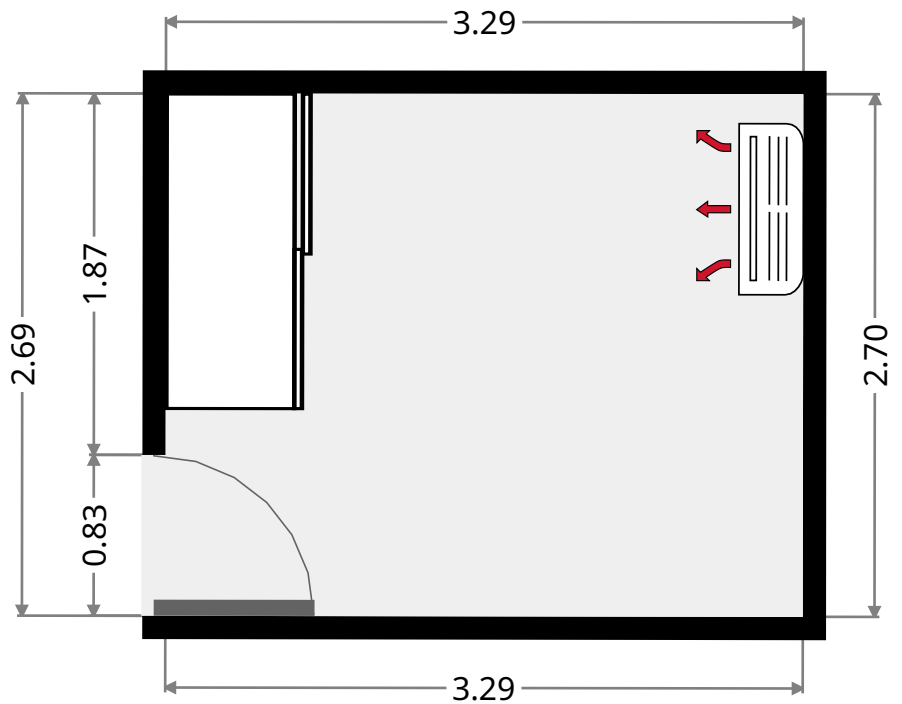
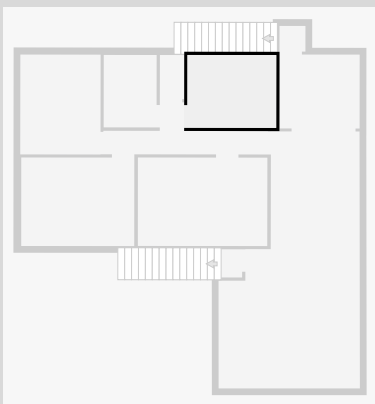

13 Standish Street

Toilet

Width: 0.90 m
Length: 1.63 m
Area: 1.47 m²
Perimeter: 5.07 m

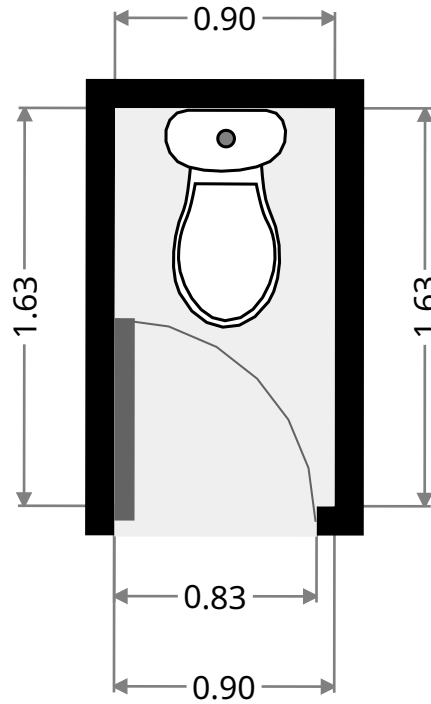
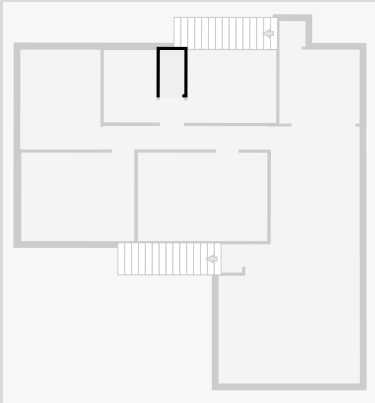

Hall

Width: 0.95 m
Length: 0.96 m
Area: 0.91 m²
Perimeter: 3.82 m

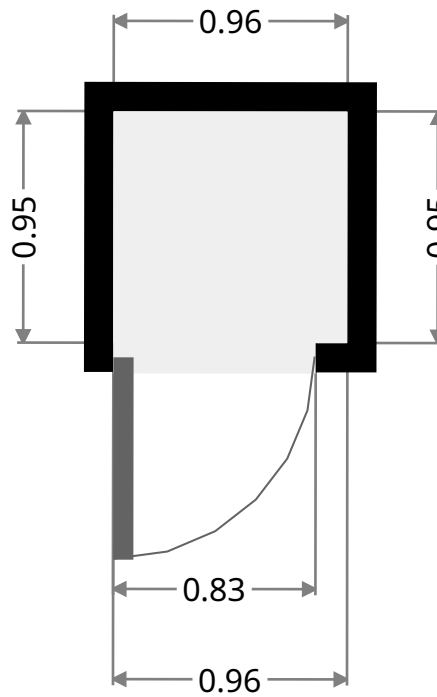
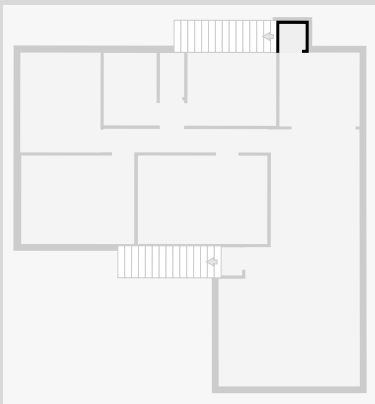

13 Standish Street

•
Width: 0.87 m
Length: 1.04 m
Area: 0.91 m²
Perimeter: 3.83 m

