

13 Sharpe Street

Ground Floor

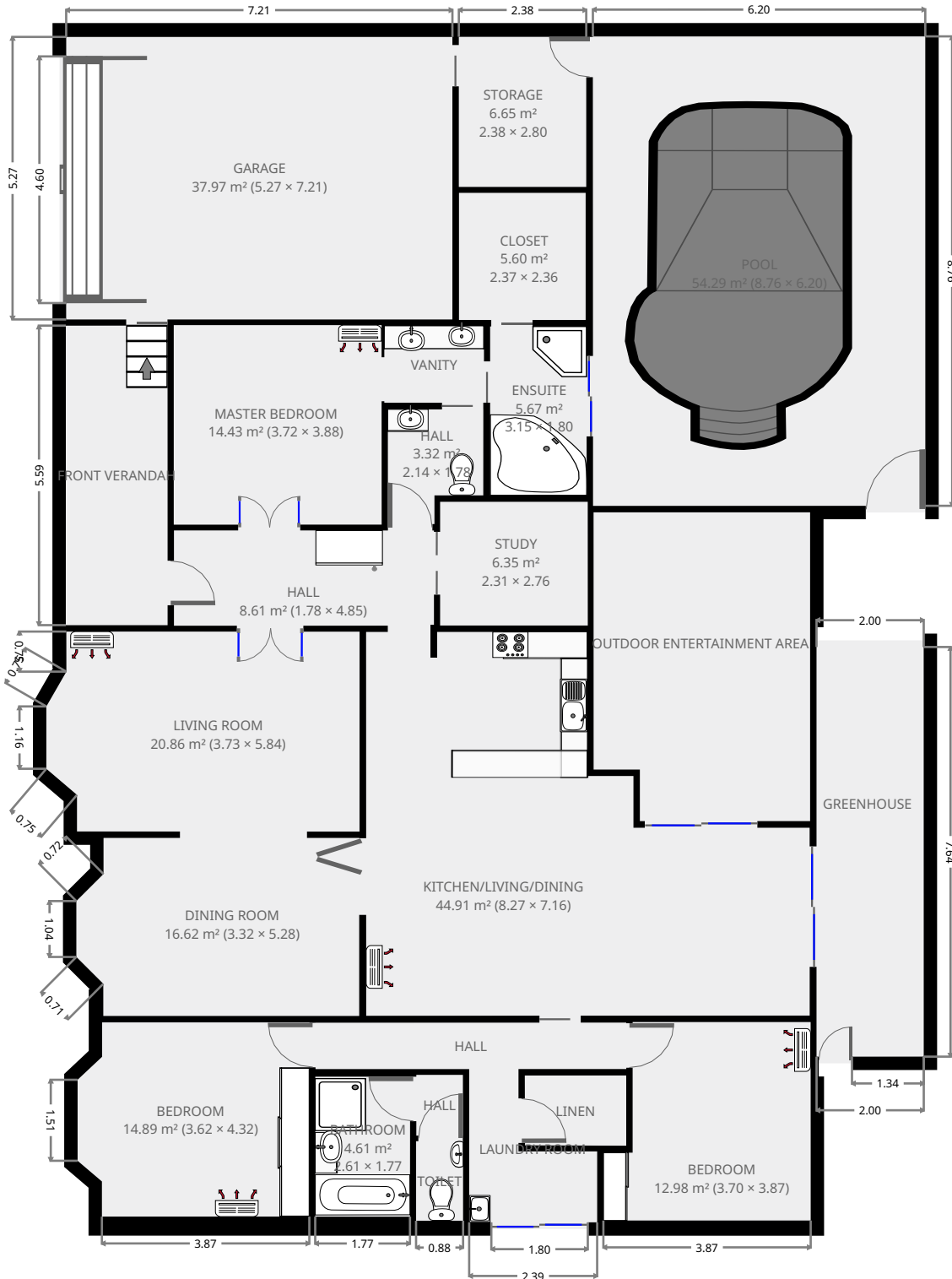

THIS FLOORPLAN IS PROVIDED WITHOUT WARRANTY OF ANY KIND. SENSOPIA DISCLAIMS ANY WARRANTY INCLUDING, WITHOUT LIMITATION, SATISFACTORY QUALITY OR ACCURACY OF DIMENSIONS.



13 Sharpe Street

Bedroom

Width: 3.62 m
 Length: 4.32 m
 Area: 14.89 m²
 Perimeter: 15.39 m

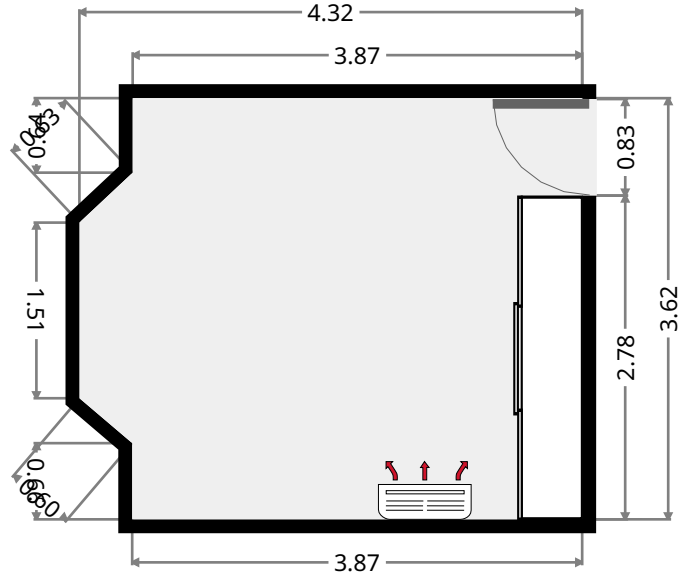
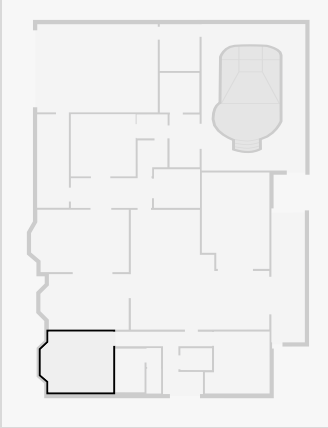

Front Verandah

Width: 1.90 m
 Length: 5.59 m
 Area: 10.60 m²
 Perimeter: 14.97 m

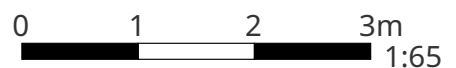
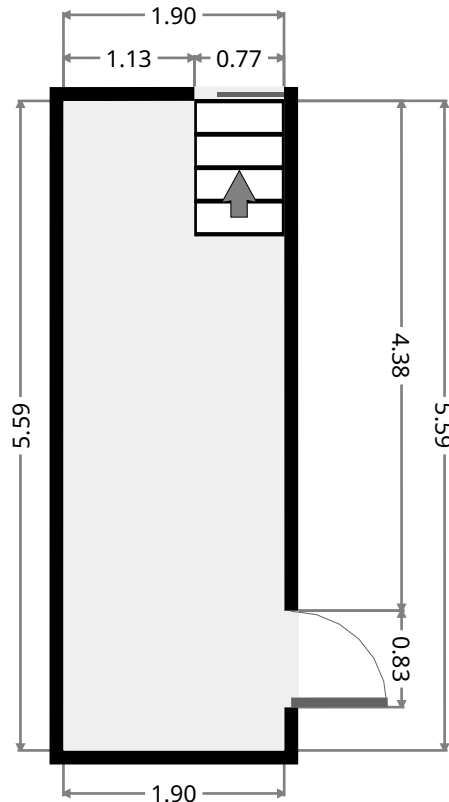
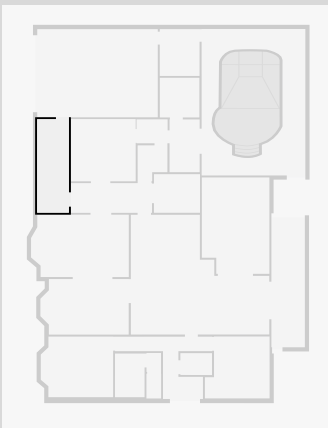

13 Sharpe Street

Storage

Width: 2.38 m
Length: 2.80 m
Area: 6.65 m²
Perimeter: 10.35 m

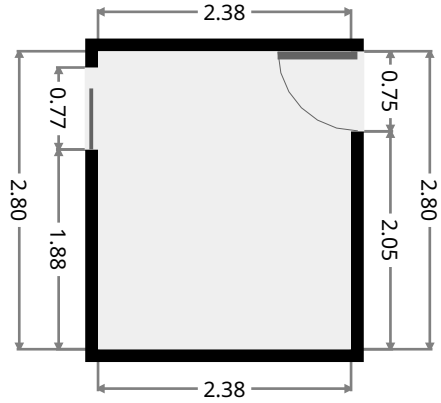
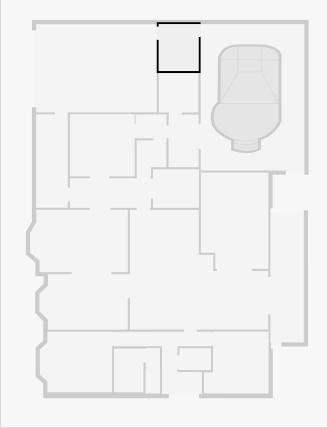

Garage

Width: 5.27 m
Length: 7.21 m
Area: 37.97 m²
Perimeter: 24.95 m

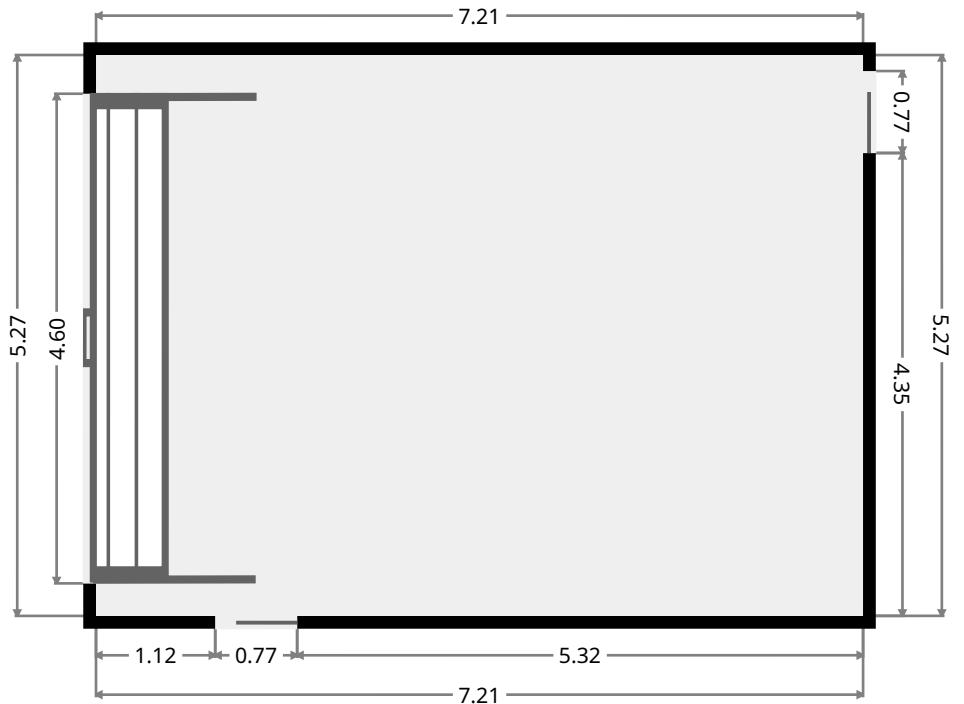
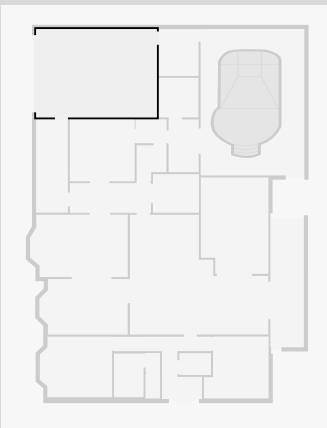

13 Sharpe Street

Greenhouse

Width: 2.00 m
 Length: 7.64 m
 Area: 15.28 m²
 Perimeter: 19.28 m

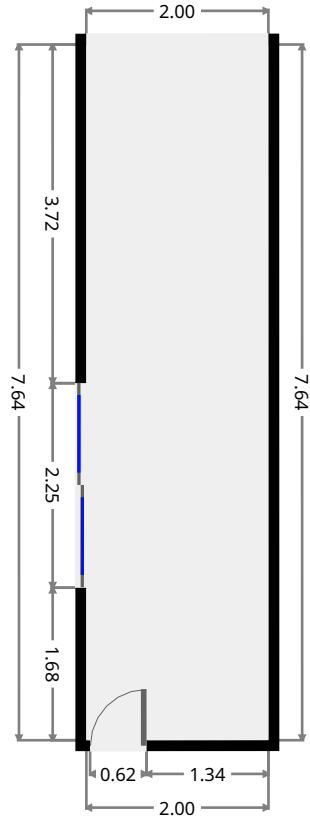
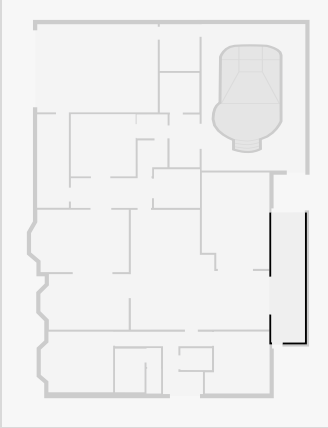

Outdoor Entertainment Area

Width: 4.04 m
 Length: 5.76 m
 Area: 22.43 m²
 Perimeter: 19.60 m

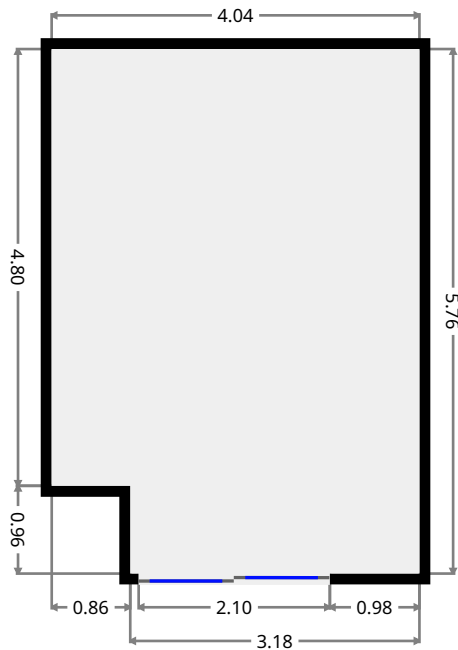
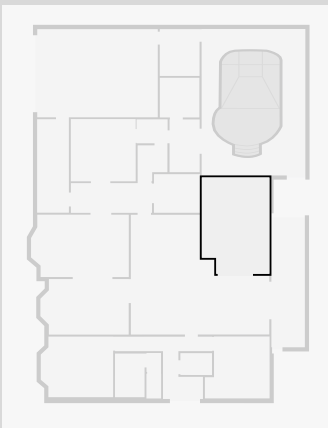

13 Sharpe Street

Pool

Width: 6.20 m
Length: 8.76 m
Area: 54.29 m²
Perimeter: 29.91 m

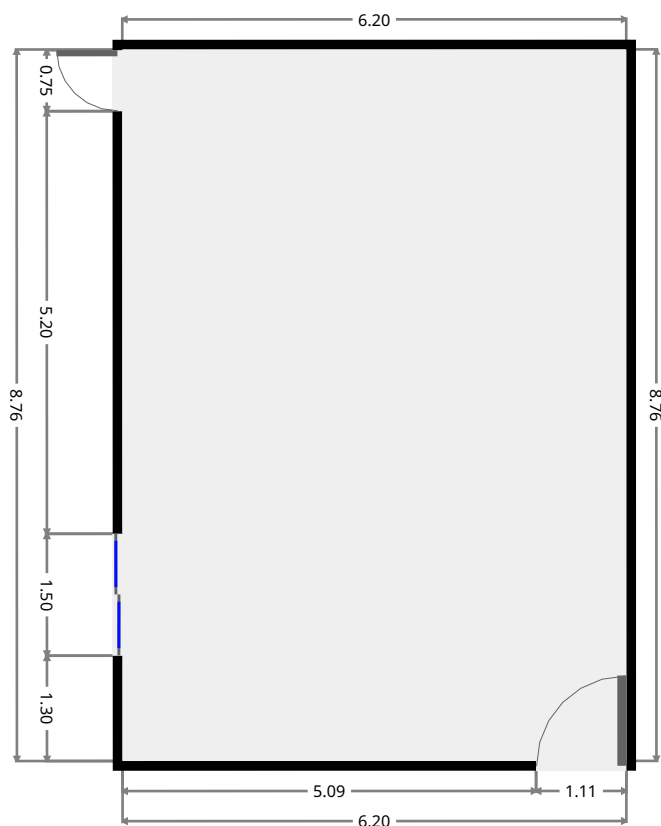
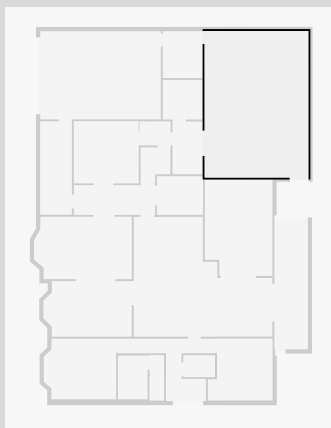

Closet

Width: 2.36 m
Length: 2.37 m
Area: 5.60 m²
Perimeter: 9.47 m

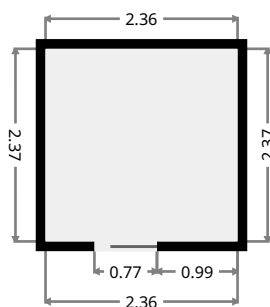
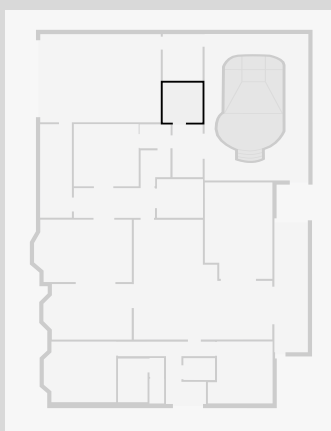

13 Sharpe Street

Ensuite

Width: 1.80 m
Length: 3.15 m
Area: 5.67 m²
Perimeter: 9.90 m

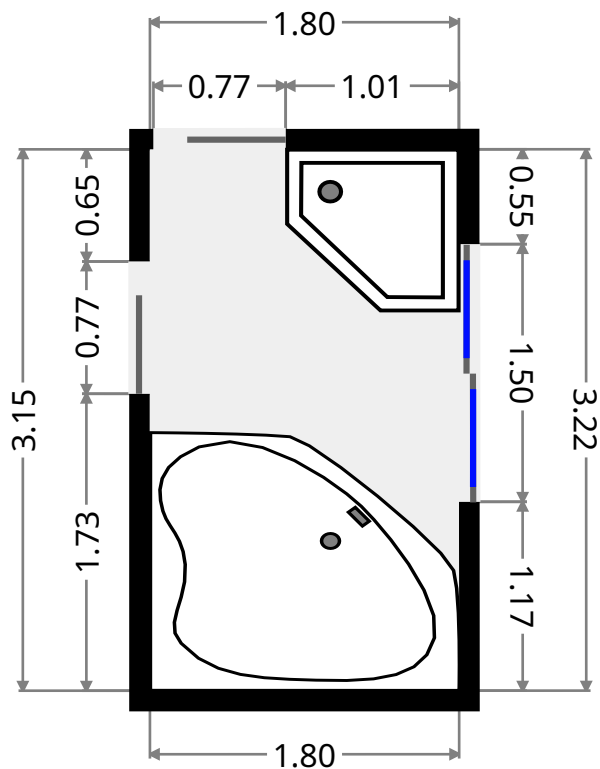
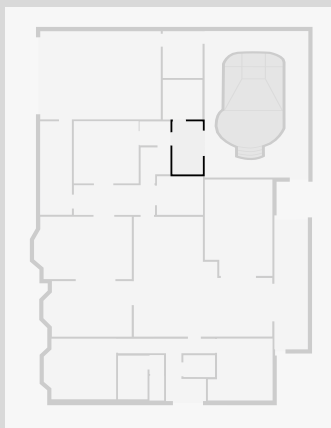

Vanity

Width: 1.43 m
Length: 1.86 m
Area: 2.66 m²
Perimeter: 6.58 m

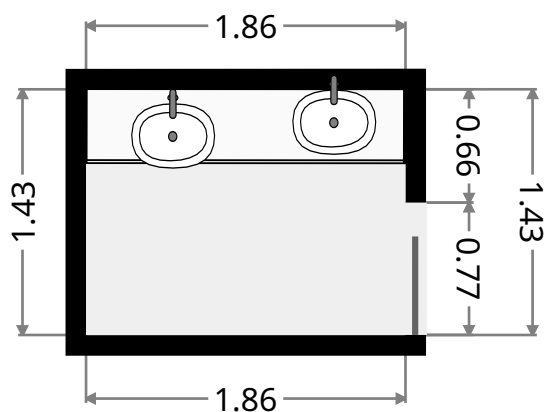
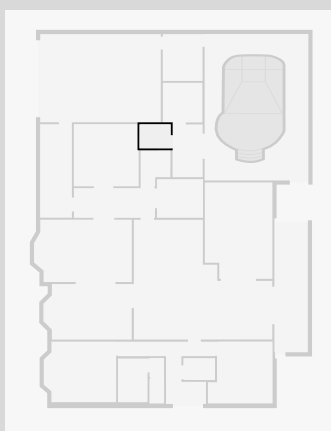

13 Sharpe Street

Study

Width: 2.31 m
 Length: 2.76 m
 Area: 6.35 m²
 Perimeter: 10.12 m

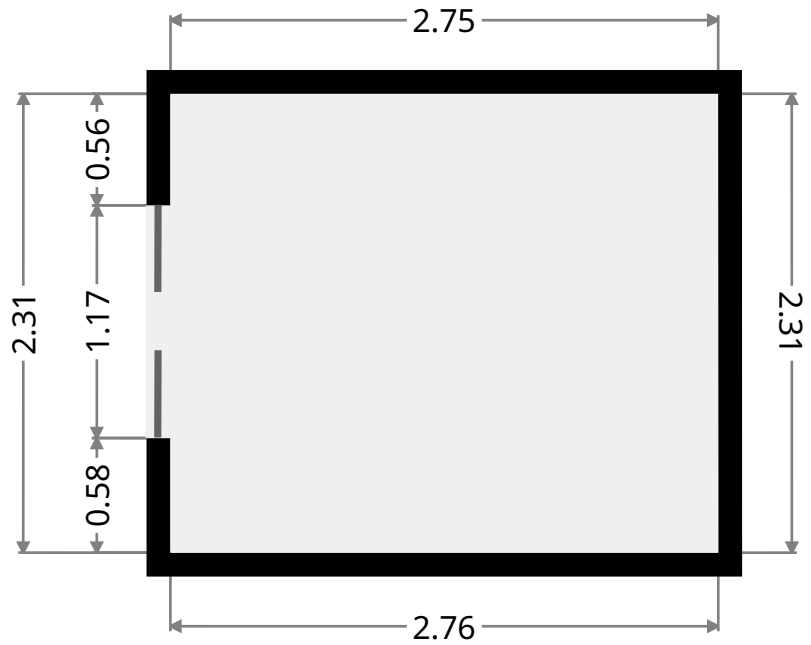
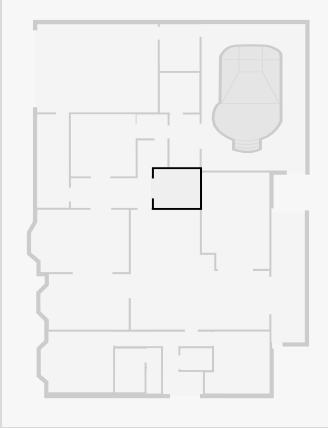

Hall

Width: 1.78 m
 Length: 2.14 m
 Area: 3.32 m²
 Perimeter: 7.84 m

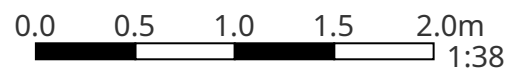
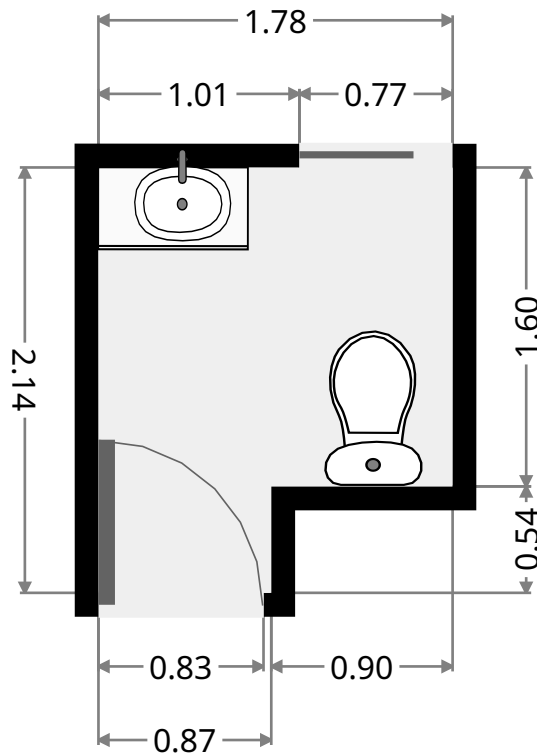
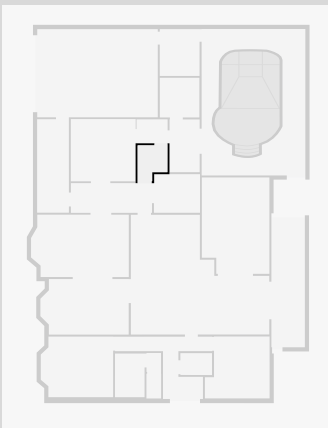

THIS FLOORPLAN IS PROVIDED WITHOUT WARRANTY OF ANY KIND. SENSOPIA DISCLAIMS ANY WARRANTY INCLUDING, WITHOUT LIMITATION, SATISFACTORY QUALITY OR ACCURACY OF DIMENSIONS.

13 Sharpe Street

Hall

Width: 1.78 m
 Length: 4.85 m
 Area: 8.61 m²
 Perimeter: 13.25 m

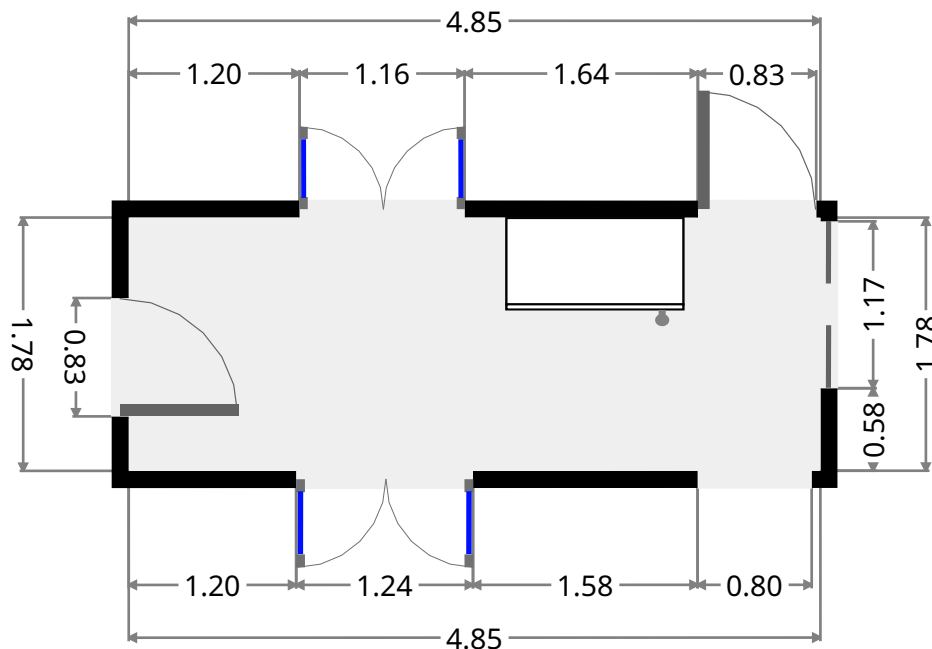
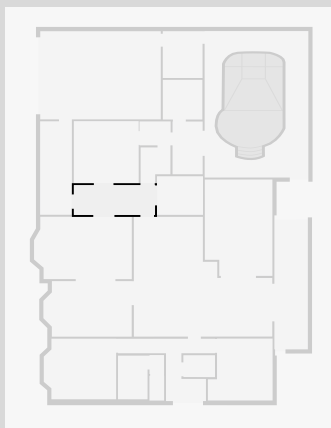

Bathroom

Width: 1.77 m
 Length: 2.61 m
 Area: 4.61 m²
 Perimeter: 8.76 m

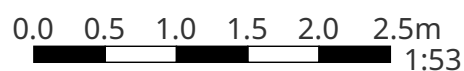
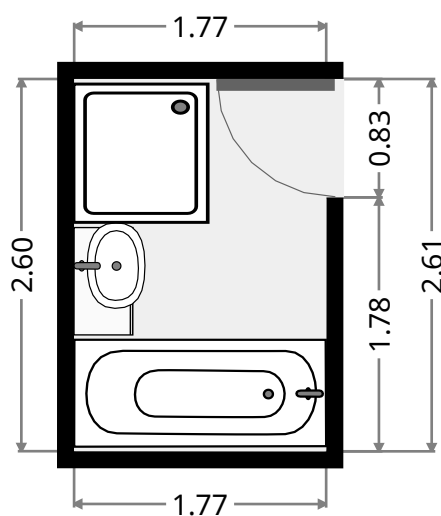
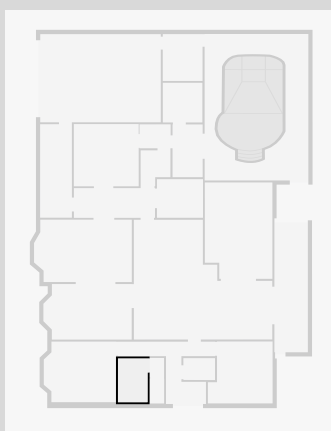

13 Sharpe Street

Toilet

Width: 0.88 m
Length: 1.48 m
Area: 1.30 m²
Perimeter: 4.72 m

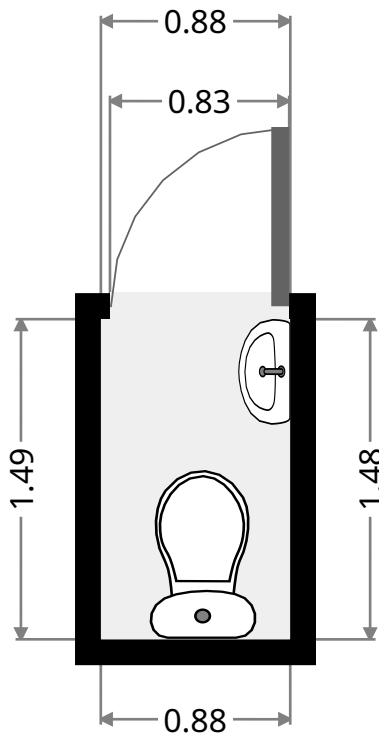
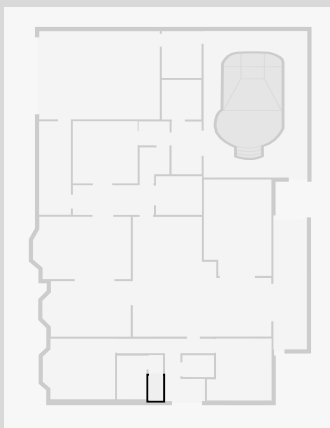

Hall

Width: 0.87 m
Length: 1.13 m
Area: 0.99 m²
Perimeter: 4.01 m

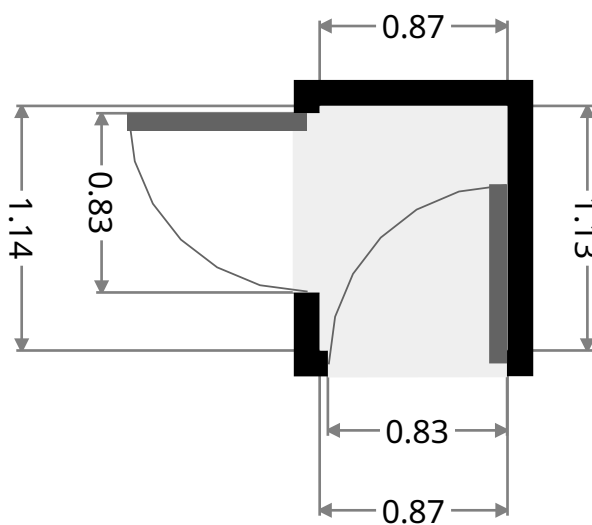
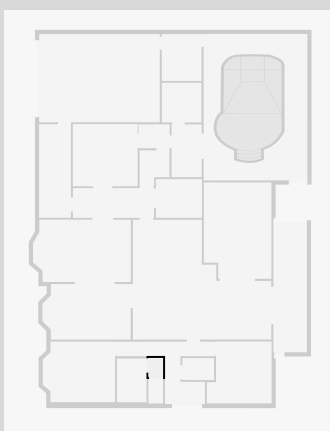

13 Sharpe Street

Linen

Width: 1.30 m
 Length: 1.89 m
 Area: 2.47 m²
 Perimeter: 6.39 m

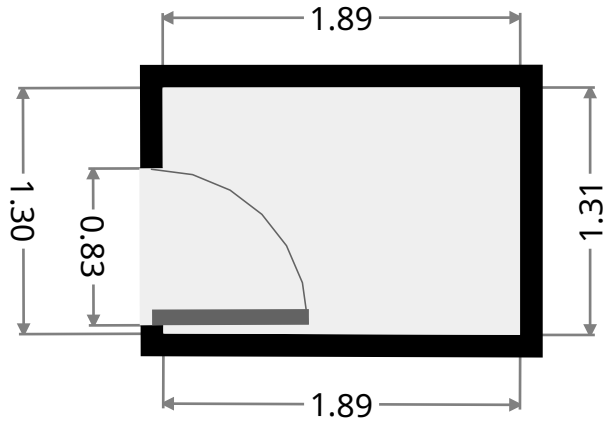
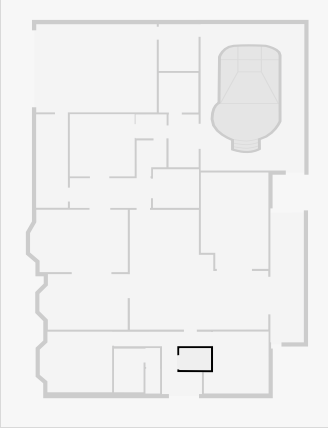

Laundry Room

Width: 2.39 m
 Length: 2.75 m
 Area: 4.47 m²
 Perimeter: 10.27 m

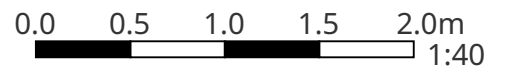
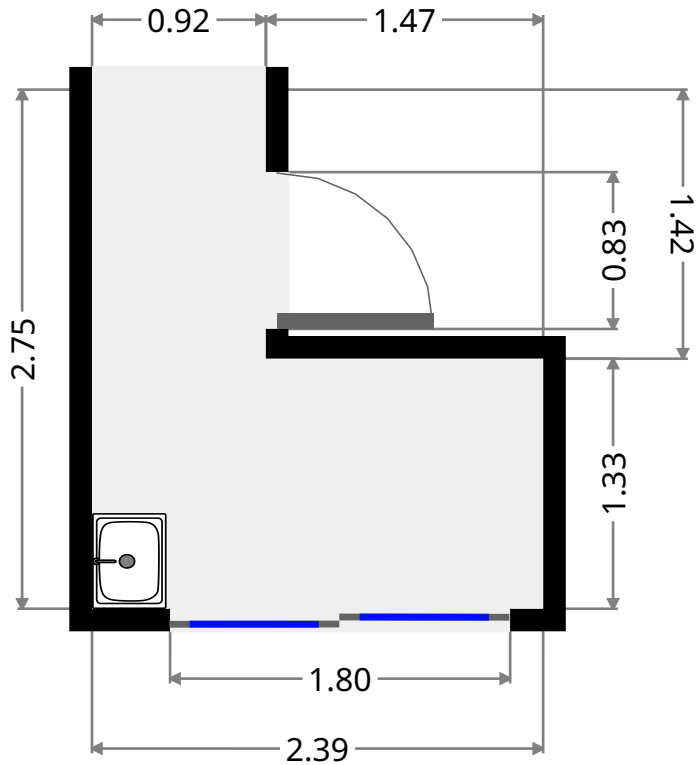
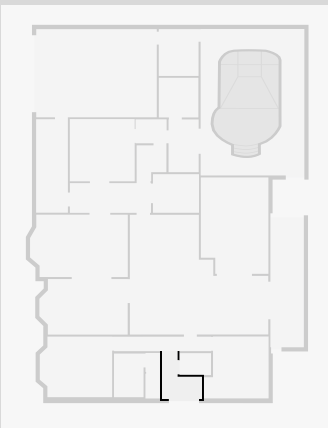

THIS FLOORPLAN IS PROVIDED WITHOUT WARRANTY OF ANY KIND. SENSOPIA DISCLAIMS ANY WARRANTY INCLUDING, WITHOUT LIMITATION, SATISFACTORY QUALITY OR ACCURACY OF DIMENSIONS.

13 Sharpe Street

Bedroom

Width: 3.70 m
 Length: 3.87 m
 Area: 12.98 m²
 Perimeter: 15.14 m

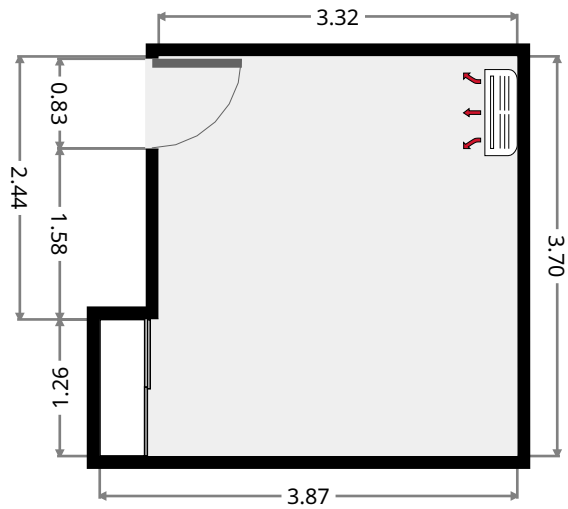
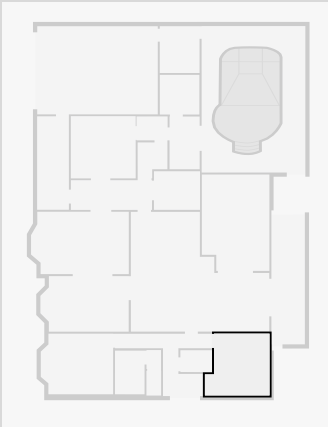

Hall

Width: 0.87 m
 Length: 5.80 m
 Area: 5.02 m²
 Perimeter: 13.33 m

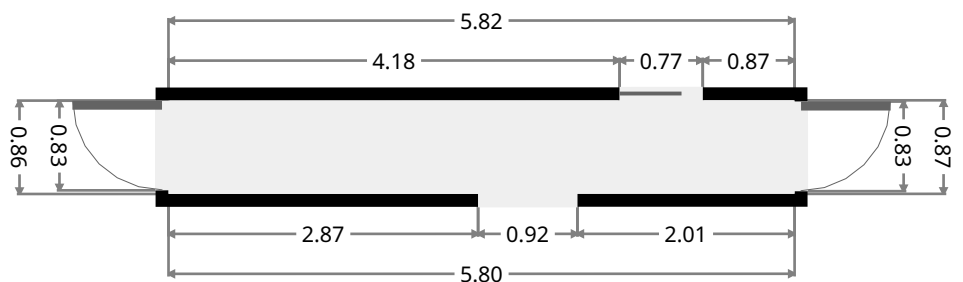
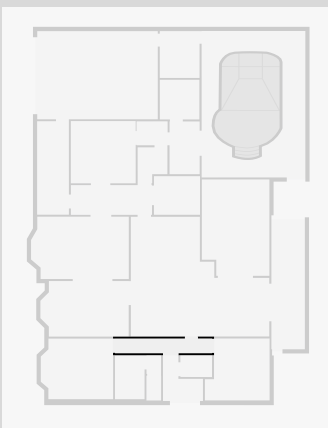

13 Sharpe Street

Kitchen/Living/Dining

Width: 7.16 m
 Length: 8.27 m
 Area: 44.91 m²
 Perimeter: 30.86 m

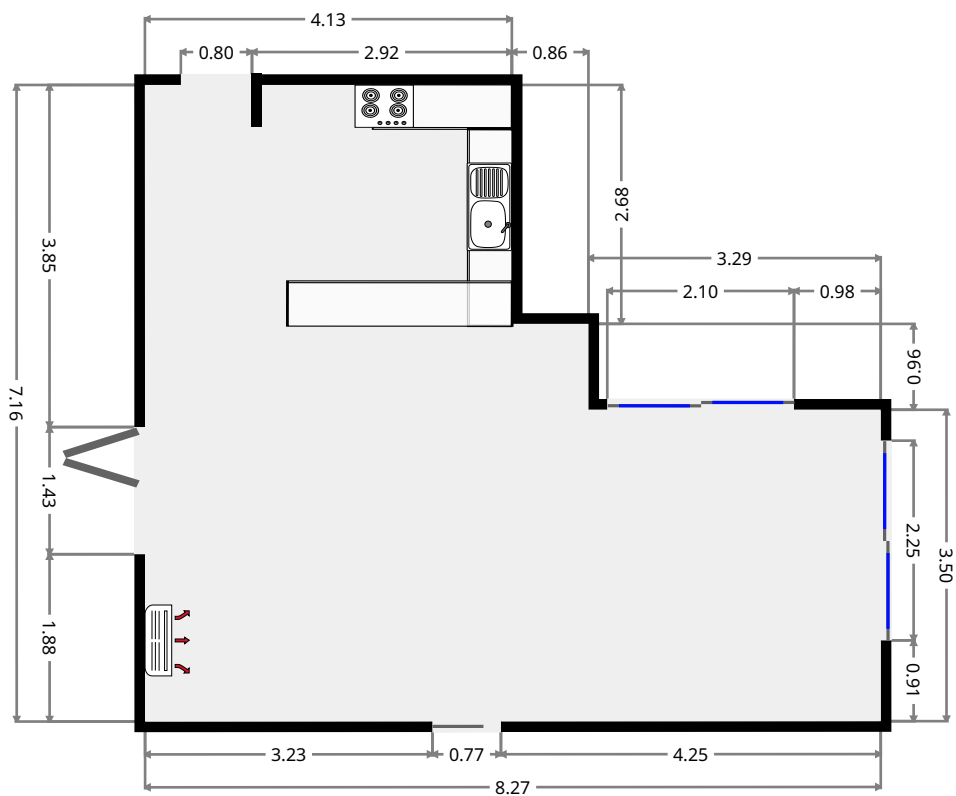
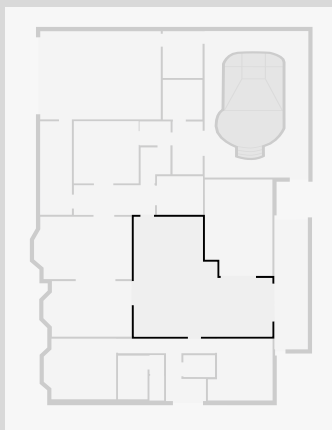

Dining Room

Width: 3.32 m
 Length: 5.28 m
 Area: 16.62 m²
 Perimeter: 16.60 m

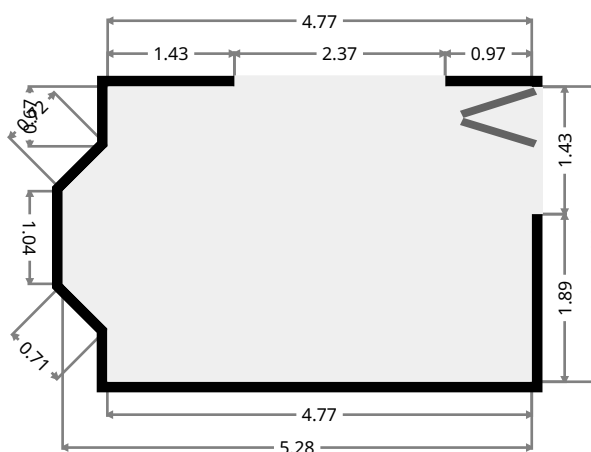
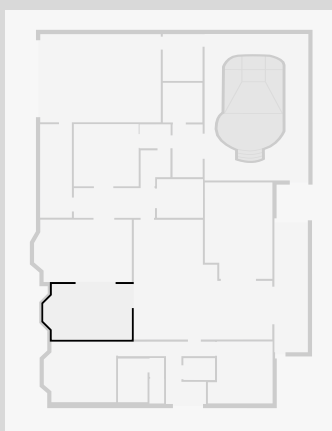

THIS FLOORPLAN IS PROVIDED WITHOUT WARRANTY OF ANY KIND. SENSOPIA DISCLAIMS ANY WARRANTY INCLUDING, WITHOUT LIMITATION, SATISFACTORY QUALITY OR ACCURACY OF DIMENSIONS.

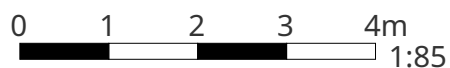

13 Sharpe Street

Living Room

Width: 3.73 m
 Length: 5.84 m
 Area: 20.86 m²
 Perimeter: 18.56 m

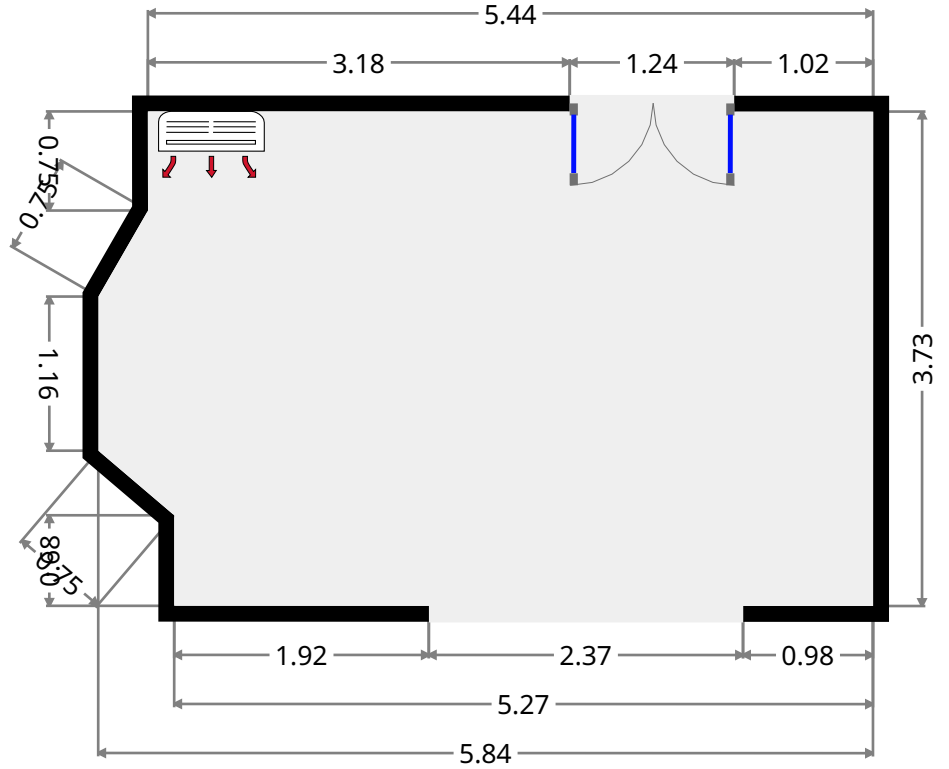
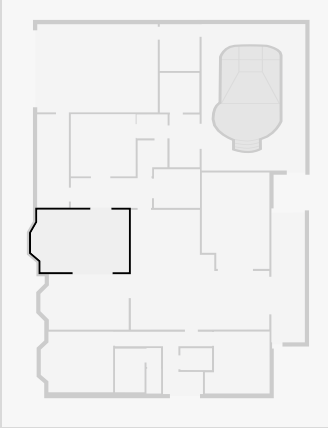

Master Bedroom

Width: 3.72 m
 Length: 3.88 m
 Area: 14.43 m²
 Perimeter: 15.20 m

