

13 Riley Drive

Ground Floor



THIS FLOORPLAN IS PROVIDED WITHOUT WARRANTY OF ANY KIND. SENSOPIA DISCLAIMS ANY WARRANTY INCLUDING, WITHOUT LIMITATION, SATISFACTORY QUALITY OR ACCURACY OF DIMENSIONS.



13 Riley Drive

Hall

Width: 5.96 m
 Length: 6.04 m
 Area: 13.55 m²
 Perimeter: 25.62 m

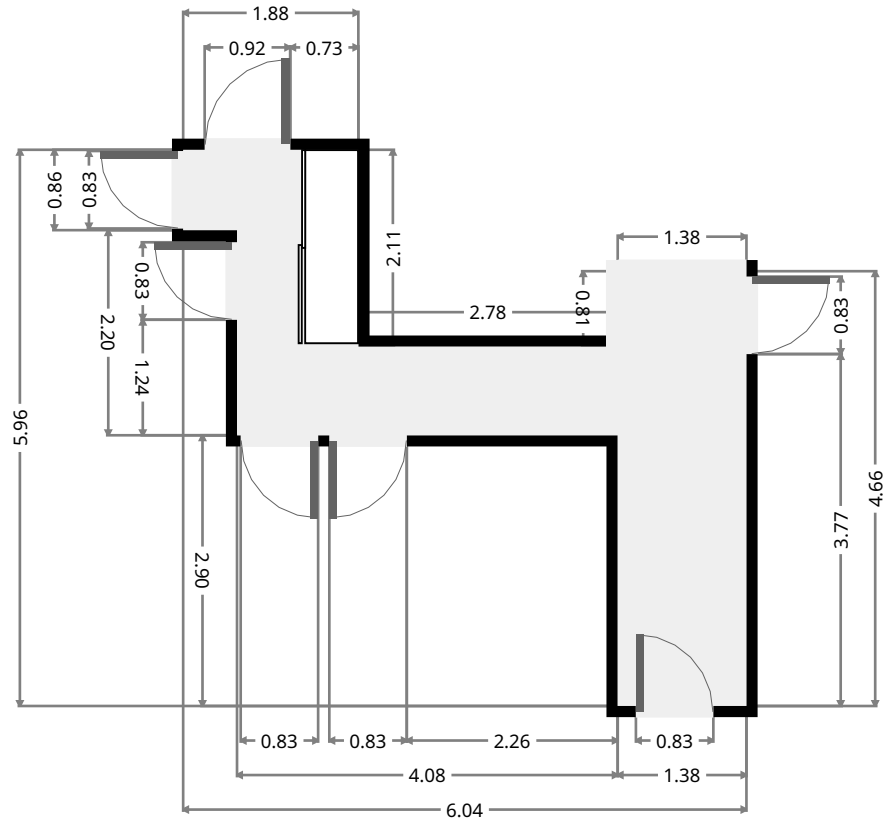
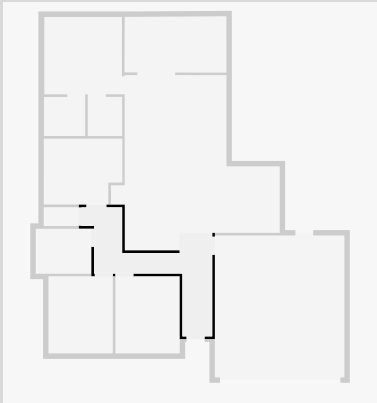

Garage

Width: 5.98 m
 Length: 6.55 m
 Area: 39.17 m²
 Perimeter: 25.06 m

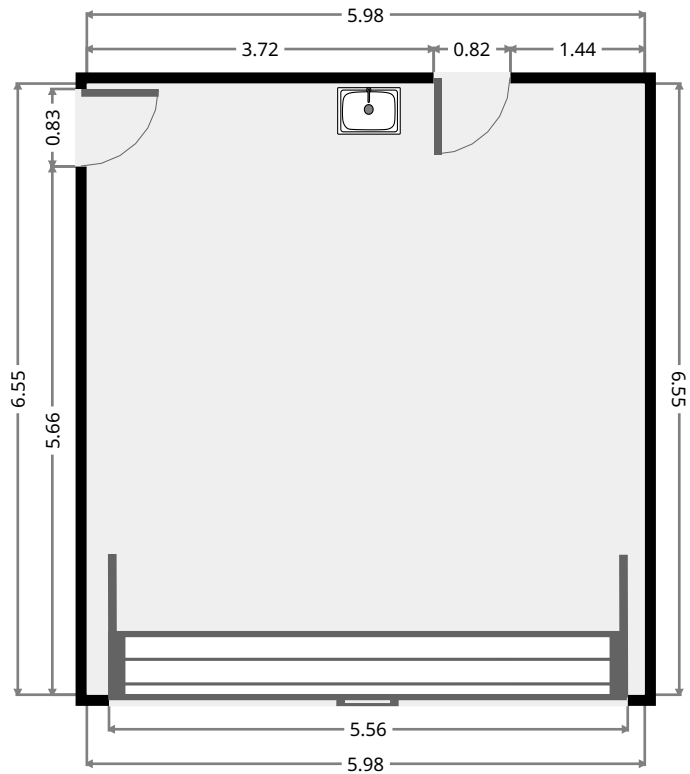
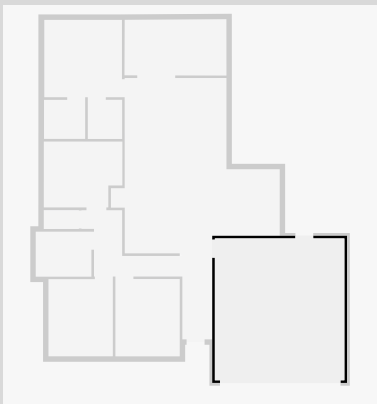

THIS FLOORPLAN IS PROVIDED WITHOUT WARRANTY OF ANY KIND. SENSOPIA DISCLAIMS ANY WARRANTY INCLUDING, WITHOUT LIMITATION, SATISFACTORY QUALITY OR ACCURACY OF DIMENSIONS.

13 Riley Drive

Bedroom

Width: 2.97 m
 Length: 3.57 m
 Area: 10.60 m²
 Perimeter: 13.08 m

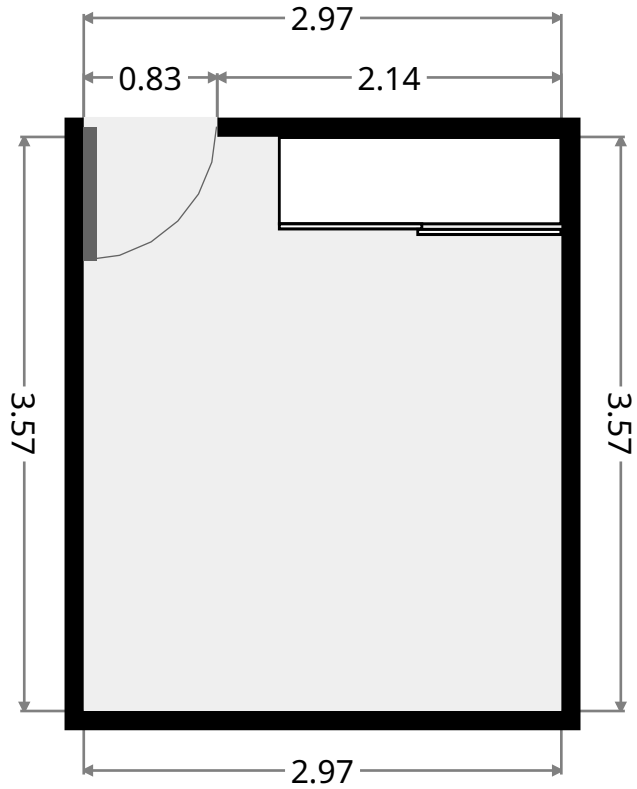
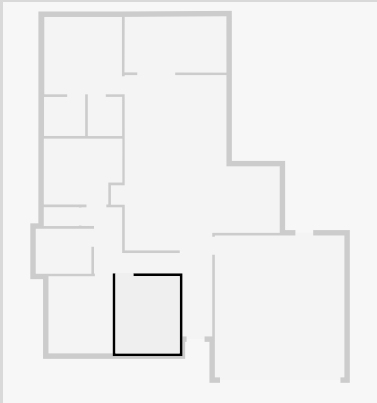

Bedroom

Width: 2.97 m
 Length: 3.56 m
 Area: 10.57 m²
 Perimeter: 13.06 m

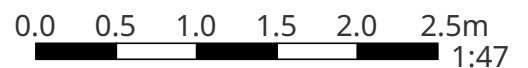
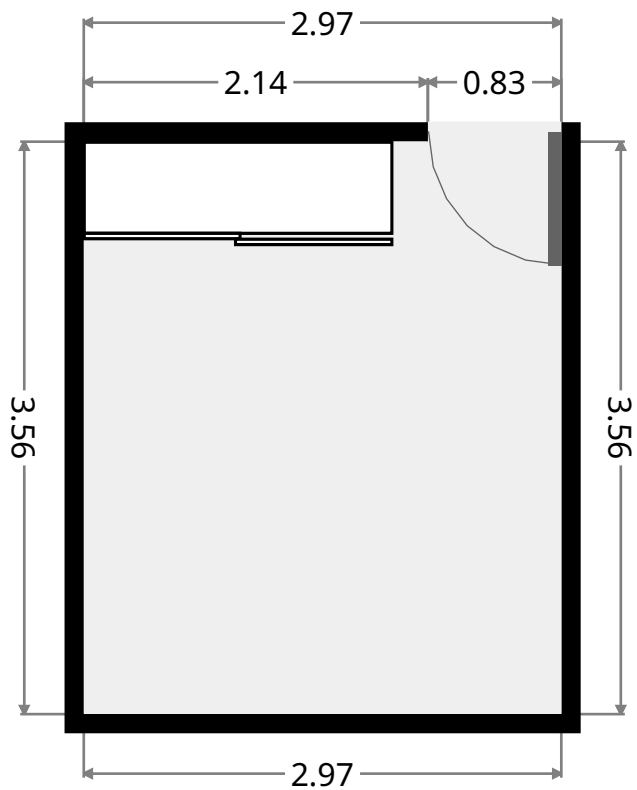
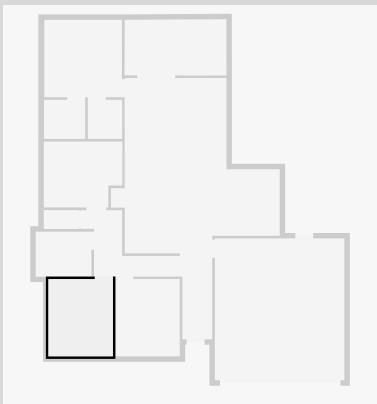

THIS FLOORPLAN IS PROVIDED WITHOUT WARRANTY OF ANY KIND. SENSOPIA DISCLAIMS ANY WARRANTY INCLUDING, WITHOUT LIMITATION, SATISFACTORY QUALITY OR ACCURACY OF DIMENSIONS.

13 Riley Drive

Bathroom

Width: 2.08 m
 Length: 2.57 m
 Area: 5.34 m²
 Perimeter: 9.30 m

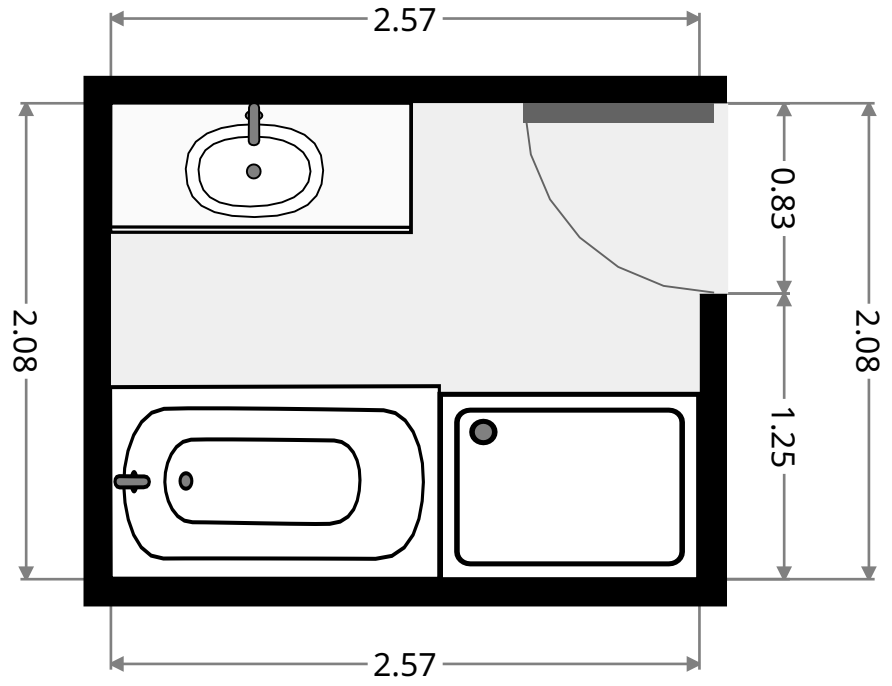
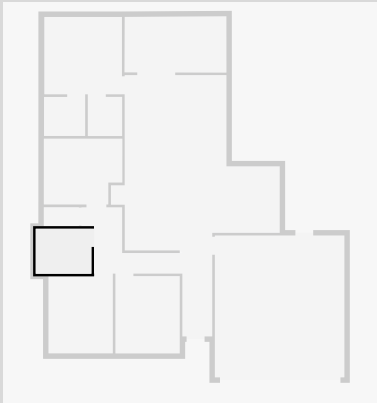

Toilet

Width: 0.87 m
 Length: 1.62 m
 Area: 1.41 m²
 Perimeter: 4.98 m

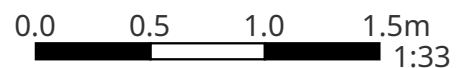
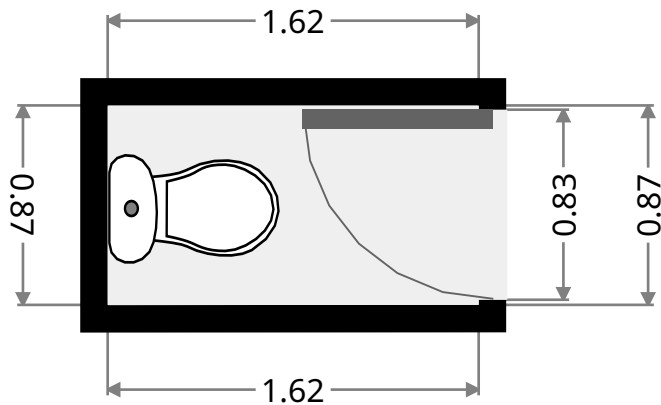
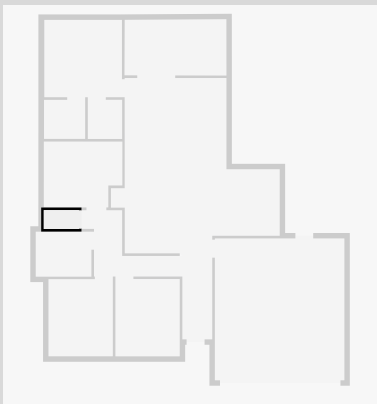

THIS FLOORPLAN IS PROVIDED WITHOUT WARRANTY OF ANY KIND. SENSOPIA DISCLAIMS ANY WARRANTY INCLUDING, WITHOUT LIMITATION, SATISFACTORY QUALITY OR ACCURACY OF DIMENSIONS.

13 Riley Drive

Bedroom

Width: 3.04 m
 Length: 3.63 m
 Area: 10.37 m²
 Perimeter: 13.33 m

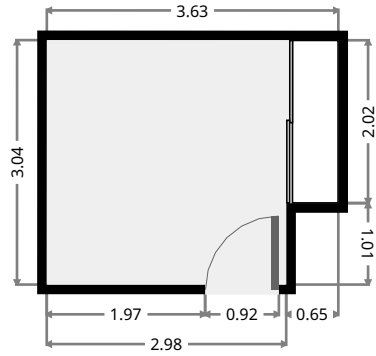
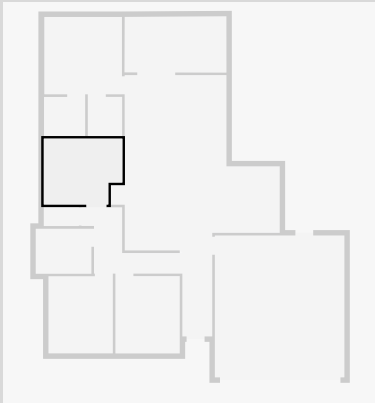

Kitchen/Living/Dining

Width: 7.79 m
 Length: 8.09 m
 Area: 44.40 m²
 Perimeter: 31.78 m

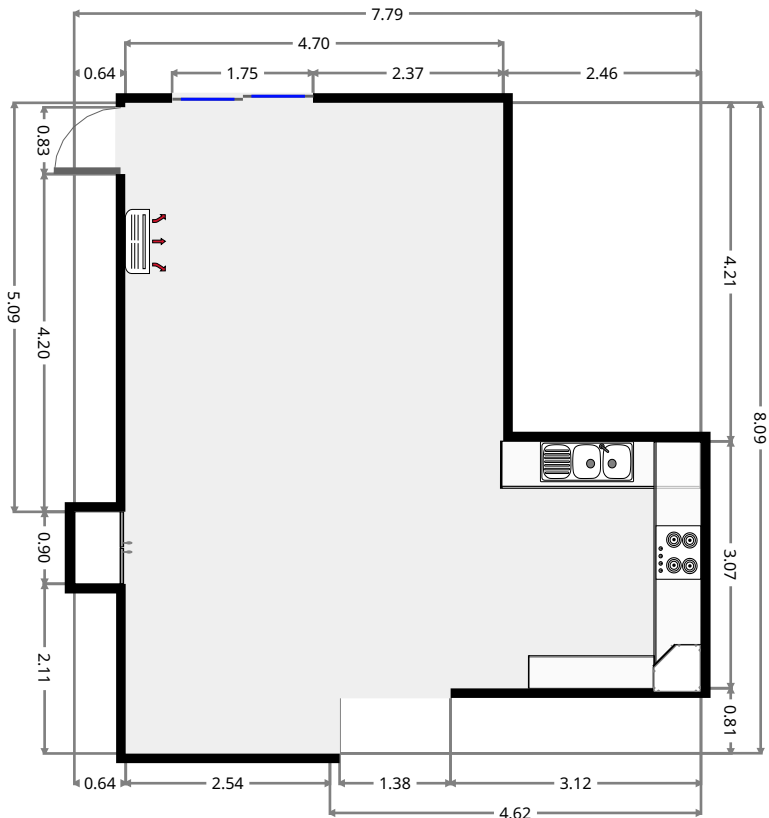
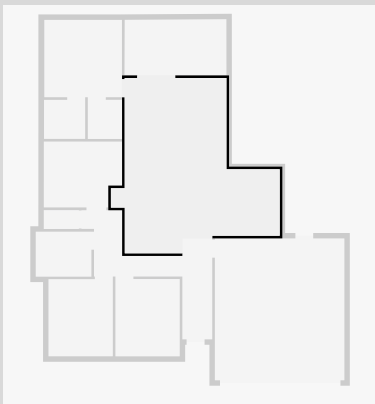

THIS FLOORPLAN IS PROVIDED WITHOUT WARRANTY OF ANY KIND. SENSOPIA DISCLAIMS ANY WARRANTY INCLUDING, WITHOUT LIMITATION, SATISFACTORY QUALITY OR ACCURACY OF DIMENSIONS.

13 Riley Drive

Master Bedroom

Width: 3.57 m
 Length: 3.58 m
 Area: 12.79 m²
 Perimeter: 14.31 m

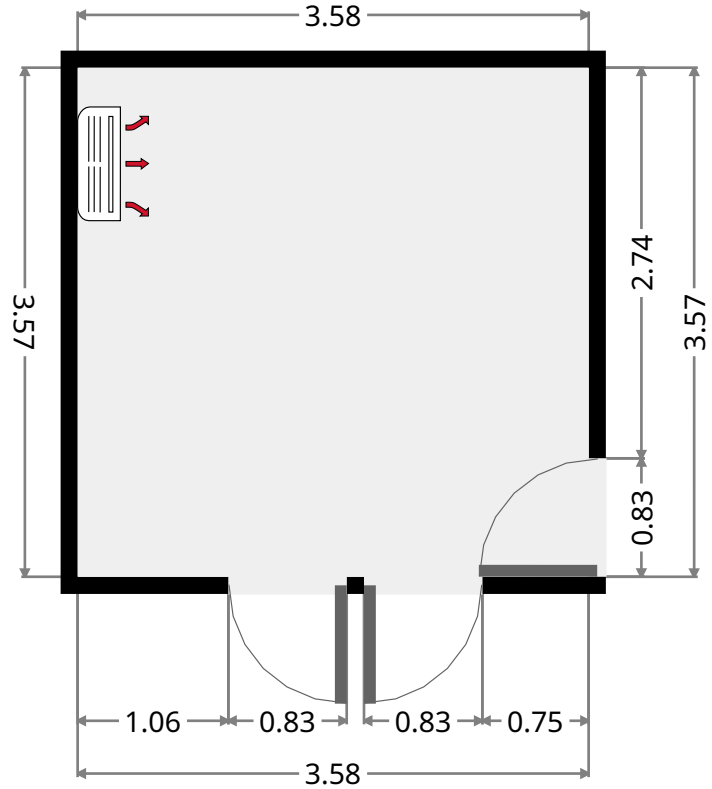
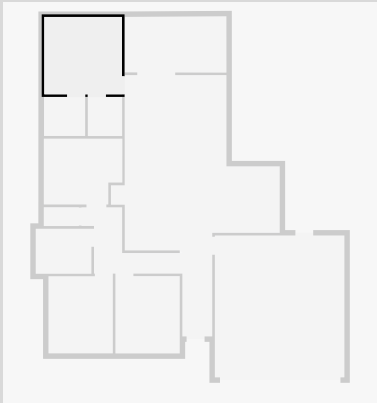

Bathroom

Width: 1.80 m
 Length: 1.90 m
 Area: 3.42 m²
 Perimeter: 7.40 m

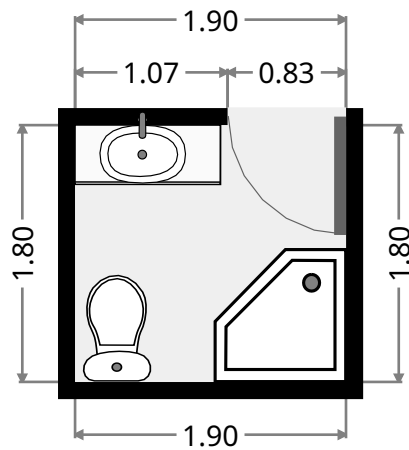
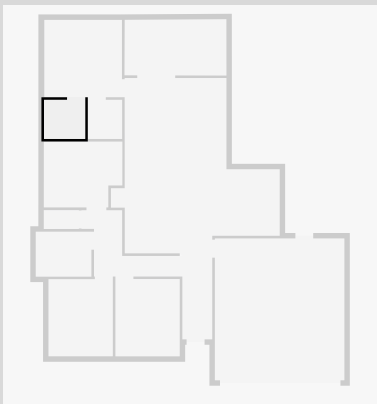

13 Riley Drive

WIR

Width: 1.59 m
Length: 1.81 m
Area: 2.87 m²
Perimeter: 6.79 m

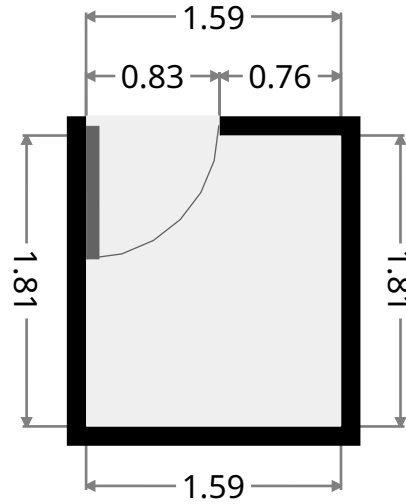
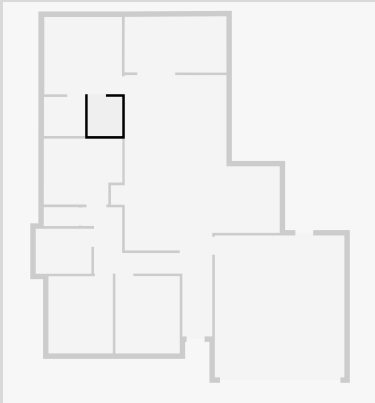

Outdoor Area

Width: 2.60 m
Length: 4.71 m
Area: 12.14 m²
Perimeter: 14.57 m

