

# 127 Edington Street

## 1st Floor

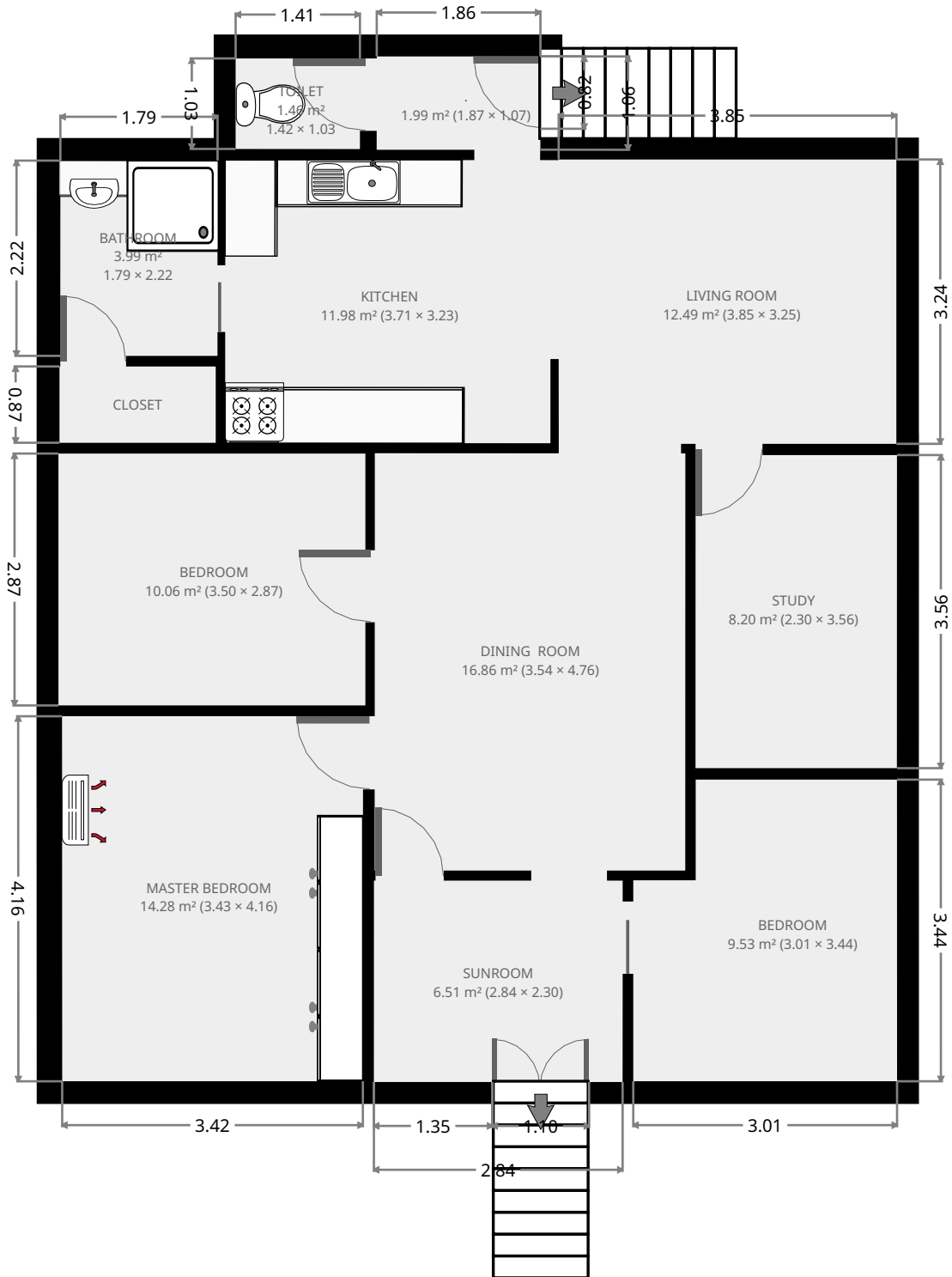

THIS FLOORPLAN IS PROVIDED WITHOUT WARRANTY OF ANY KIND. SENSOPIA DISCLAIMS ANY WARRANTY INCLUDING, WITHOUT LIMITATION, SATISFACTORY QUALITY OR ACCURACY OF DIMENSIONS.



# 127 Edington Street

## Living Room

Width: 3.25 m  
 Length: 3.85 m  
 Area: 12.49 m<sup>2</sup>  
 Perimeter: 14.19 m

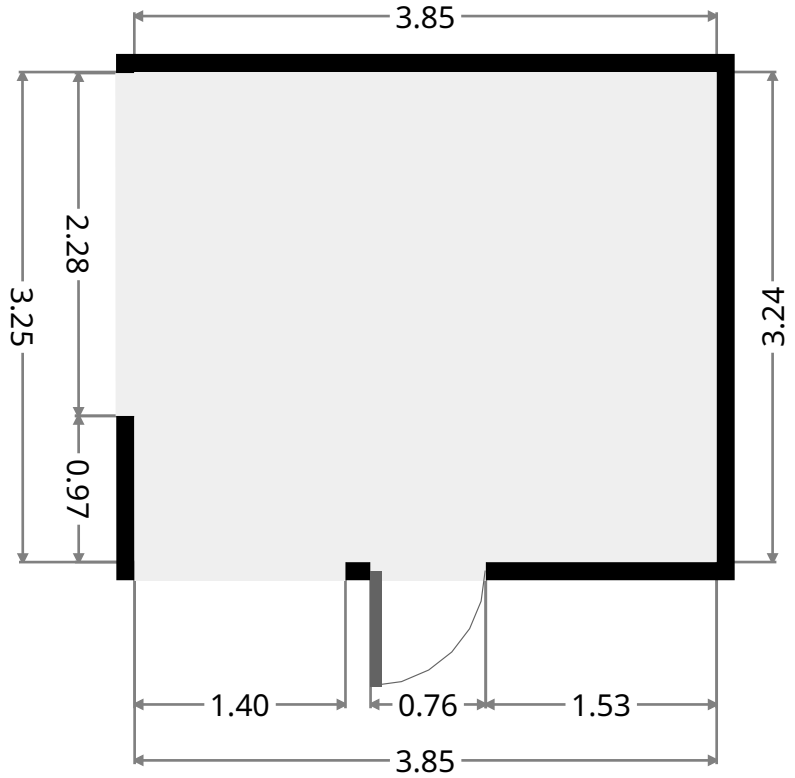
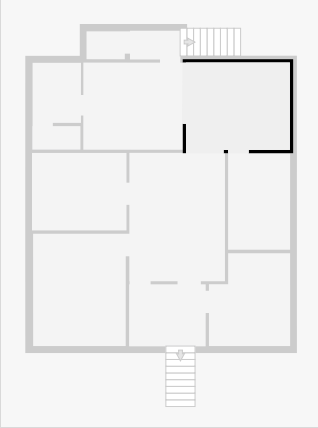

## Kitchen

Width: 3.23 m  
 Length: 3.71 m  
 Area: 11.98 m<sup>2</sup>  
 Perimeter: 13.88 m

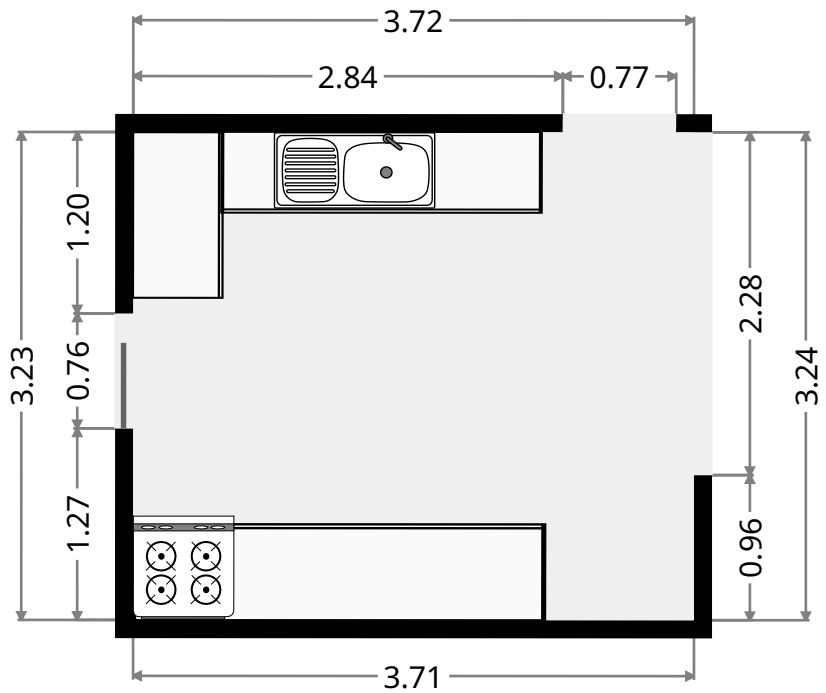
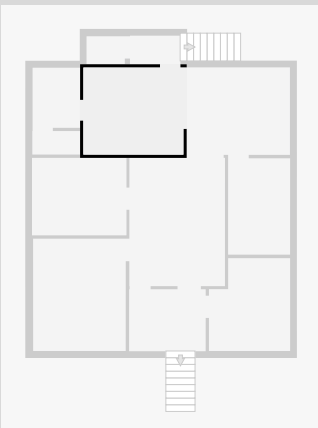

THIS FLOORPLAN IS PROVIDED WITHOUT WARRANTY OF ANY KIND. SENSOPIA DISCLAIMS ANY WARRANTY INCLUDING, WITHOUT LIMITATION, SATISFACTORY QUALITY OR ACCURACY OF DIMENSIONS.

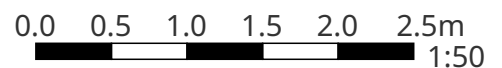

# 127 Edington Street

## Bathroom

Width: 1.79 m  
 Length: 2.22 m  
 Area: 3.99 m<sup>2</sup>  
 Perimeter: 8.04 m

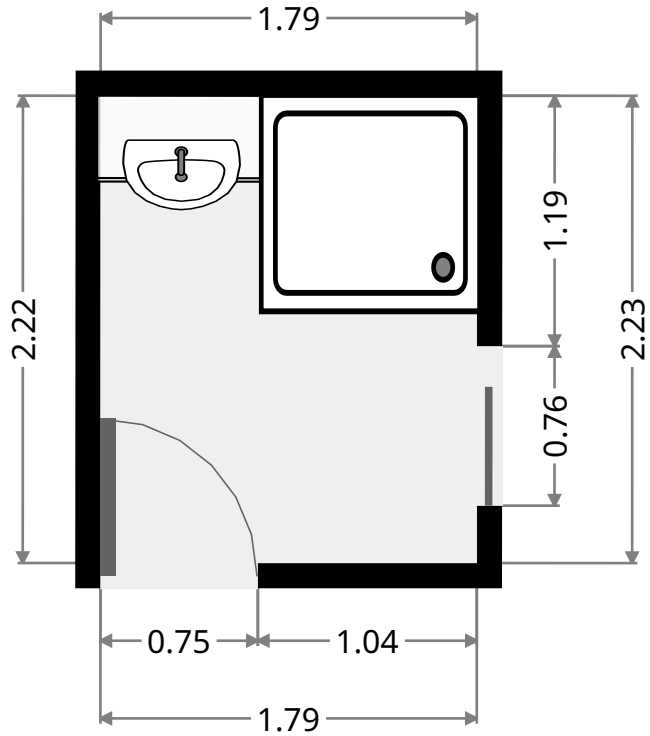
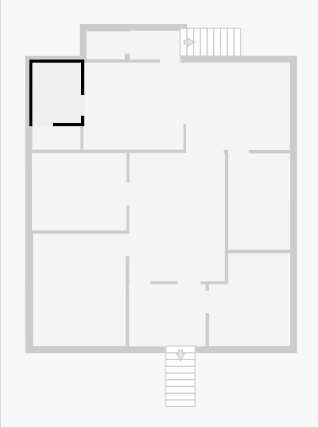

Width: 1.07 m  
 Length: 1.87 m  
 Area: 1.99 m<sup>2</sup>  
 Perimeter: 5.86 m

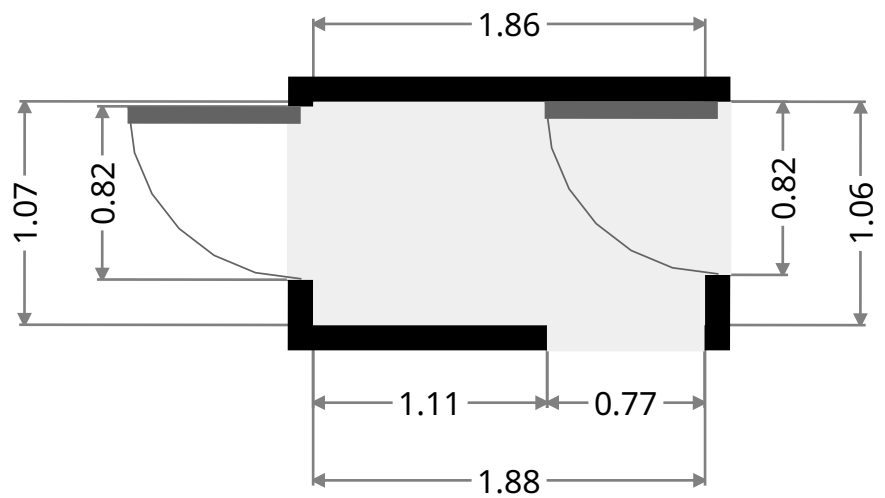
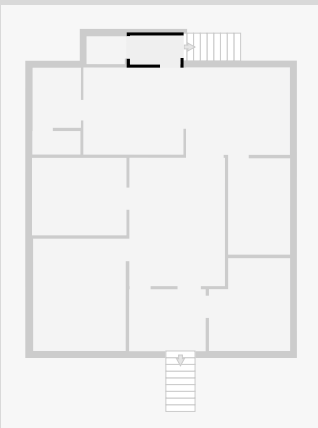

# 127 Edington Street

## Toilet

Width: 1.03 m  
Length: 1.42 m  
Area: 1.46 m<sup>2</sup>  
Perimeter: 4.90 m

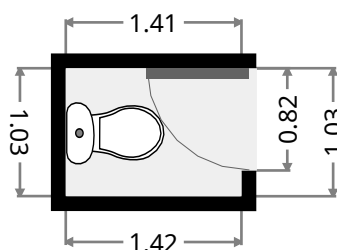
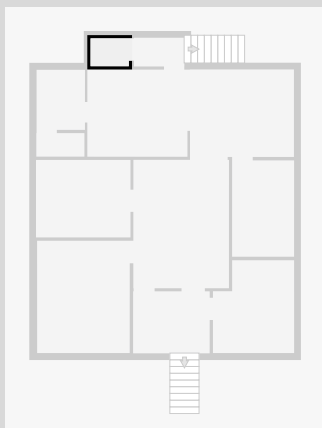

## Dining Room

Width: 3.54 m  
Length: 4.76 m  
Area: 16.86 m<sup>2</sup>  
Perimeter: 16.60 m

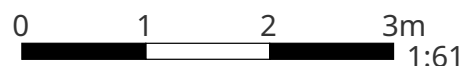
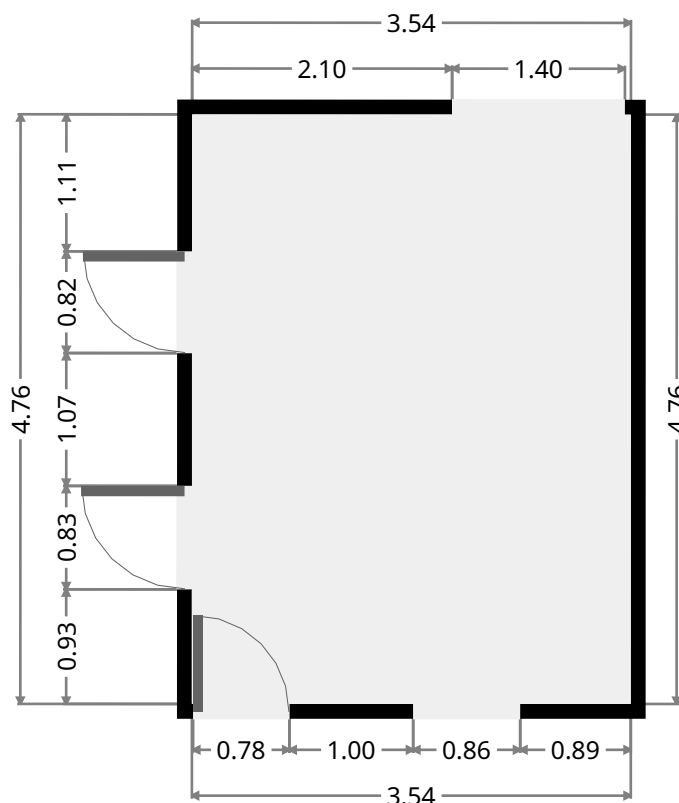
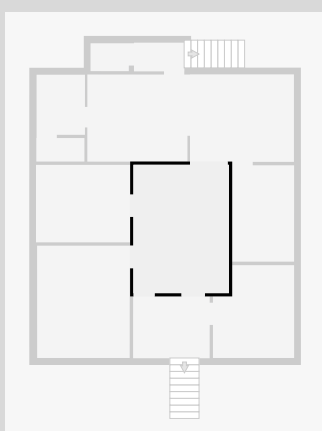

THIS FLOORPLAN IS PROVIDED WITHOUT WARRANTY OF ANY KIND. SENSOPIA DISCLAIMS ANY WARRANTY INCLUDING, WITHOUT LIMITATION, SATISFACTORY QUALITY OR ACCURACY OF DIMENSIONS.

# 127 Edington Street

## Sunroom

Width: 2.30 m  
 Length: 2.84 m  
 Area: 6.51 m<sup>2</sup>  
 Perimeter: 10.27 m

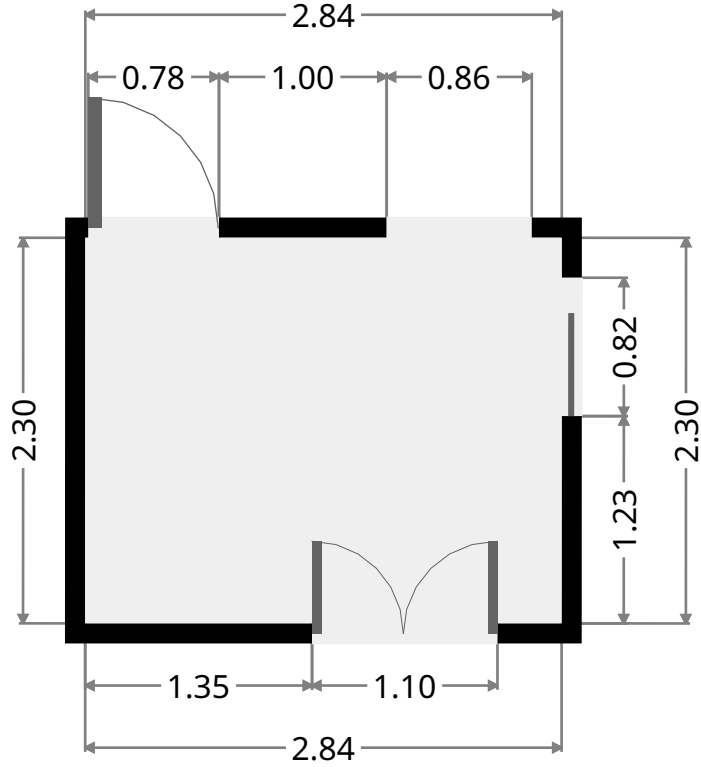
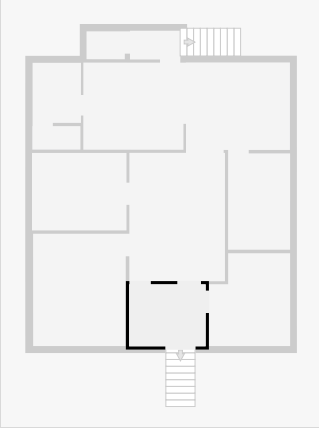

## Bedroom

Width: 3.01 m  
 Length: 3.44 m  
 Area: 9.53 m<sup>2</sup>  
 Perimeter: 12.90 m

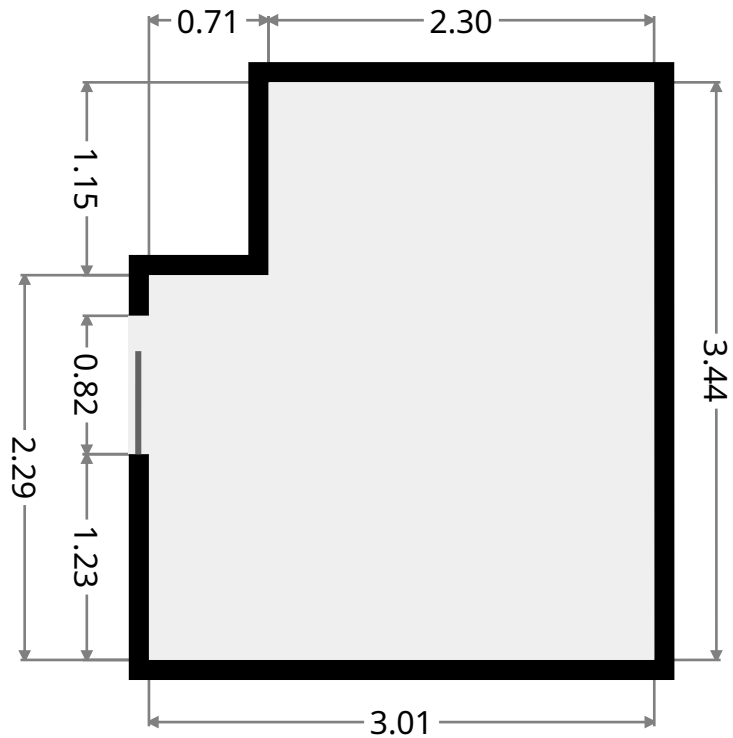
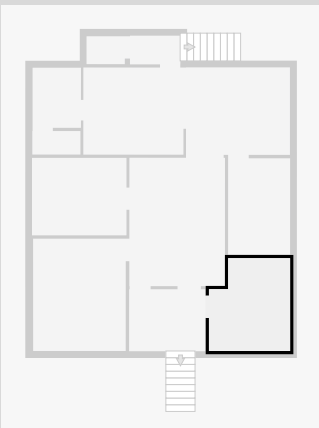

THIS FLOORPLAN IS PROVIDED WITHOUT WARRANTY OF ANY KIND. SENSOPIA DISCLAIMS ANY WARRANTY INCLUDING, WITHOUT LIMITATION, SATISFACTORY QUALITY OR ACCURACY OF DIMENSIONS.

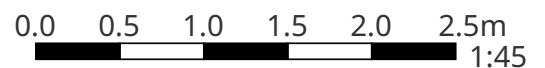

# 127 Edington Street

## Master Bedroom

Width: 3.43 m  
Length: 4.16 m  
Area: 14.28 m<sup>2</sup>  
Perimeter: 15.19 m

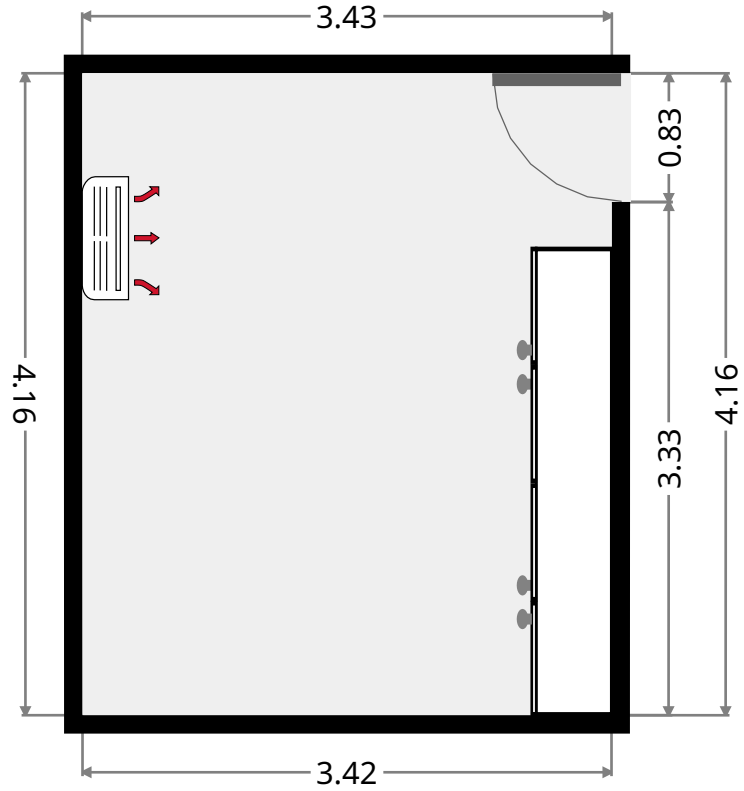
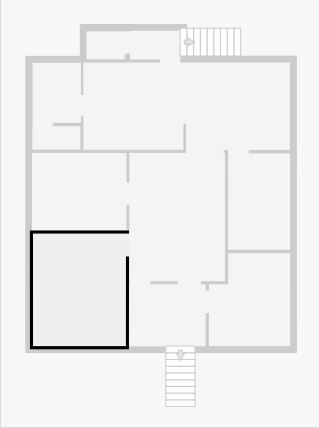

## Bedroom

Width: 2.87 m  
Length: 3.50 m  
Area: 10.06 m<sup>2</sup>  
Perimeter: 12.75 m

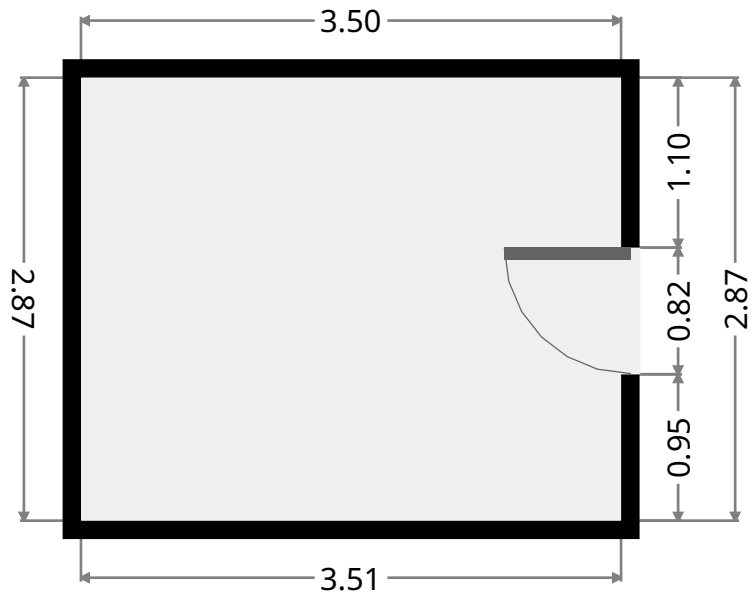
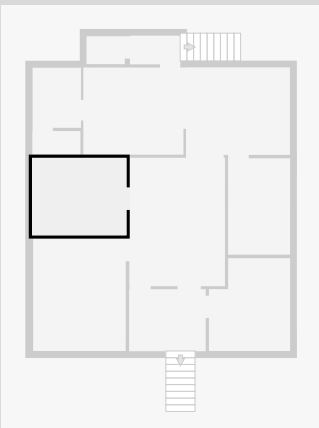

# 127 Edington Street

## Study

Width: 2.30 m  
Length: 3.56 m  
Area: 8.20 m<sup>2</sup>  
Perimeter: 11.73 m

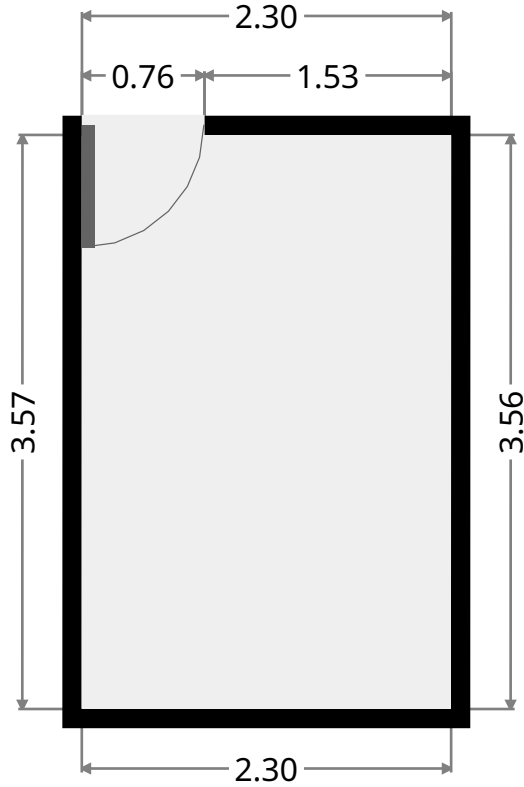
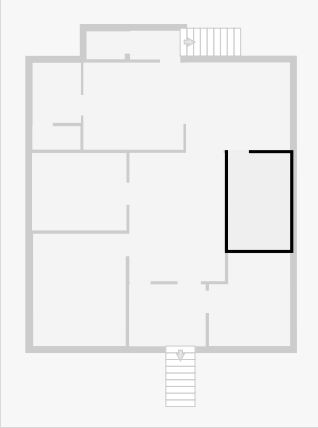

## Closet

Width: 0.87 m  
Length: 1.78 m  
Area: 1.55 m<sup>2</sup>  
Perimeter: 5.30 m

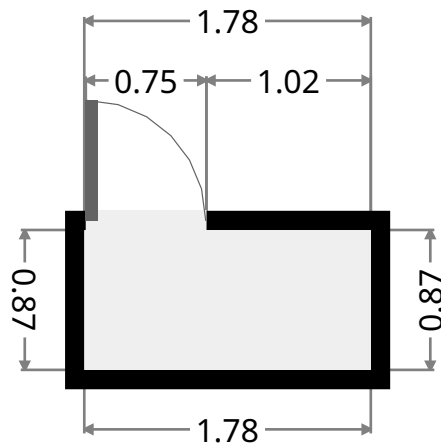
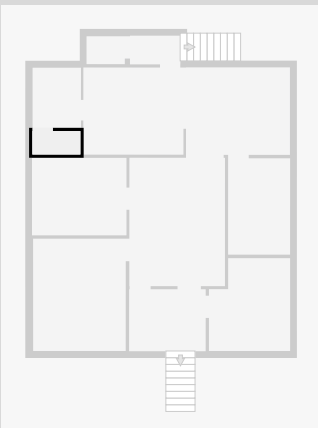

# 127 Edington Street

## Ground Floor

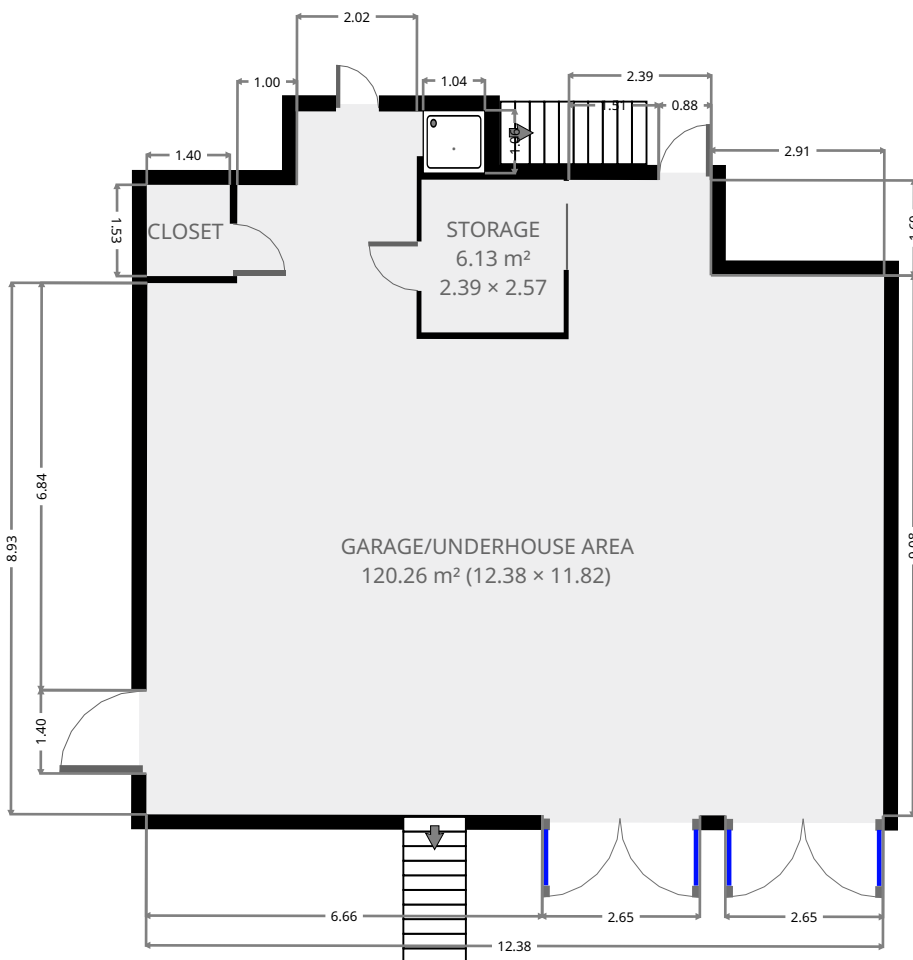
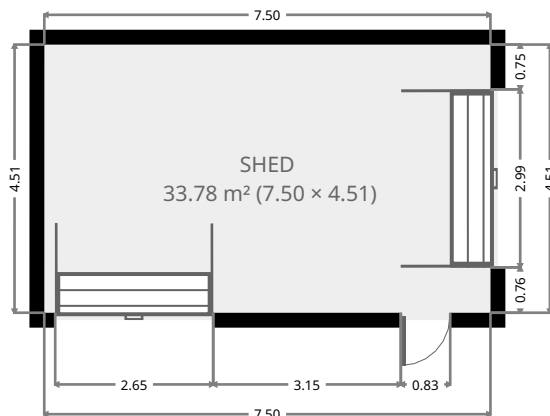

THIS FLOORPLAN IS PROVIDED WITHOUT WARRANTY OF ANY KIND. SENSOPIA DISCLAIMS ANY WARRANTY INCLUDING, WITHOUT LIMITATION, SATISFACTORY QUALITY OR ACCURACY OF DIMENSIONS.





# 127 Edington Street

## Garage/Underhouse Area

Width: 11.82 m  
Length: 12.38 m  
Area: 120.26 m<sup>2</sup>  
Perimeter: 53.76 m

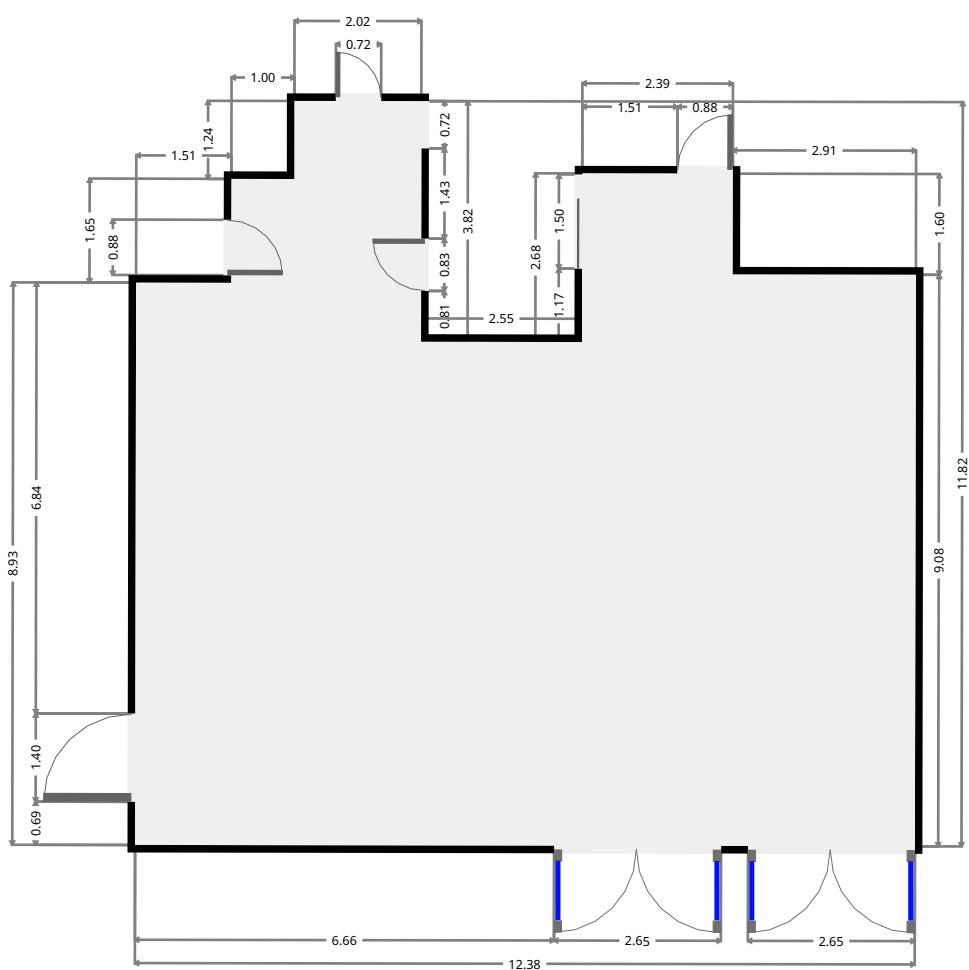
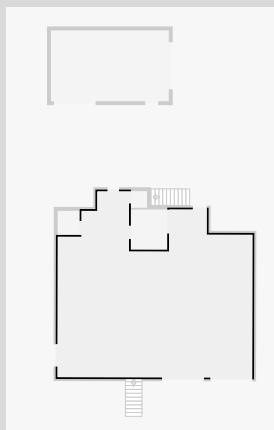

THIS FLOORPLAN IS PROVIDED WITHOUT WARRANTY OF ANY KIND. SENSOPIA DISCLAIMS ANY WARRANTY INCLUDING, WITHOUT LIMITATION, SATISFACTORY QUALITY OR ACCURACY OF DIMENSIONS.



# 127 Edington Street

•  
 Width: 1.04 m  
 Length: 1.06 m  
 Area: 1.10 m<sup>2</sup>  
 Perimeter: 4.19 m

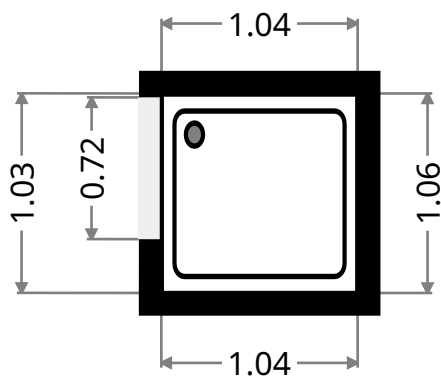
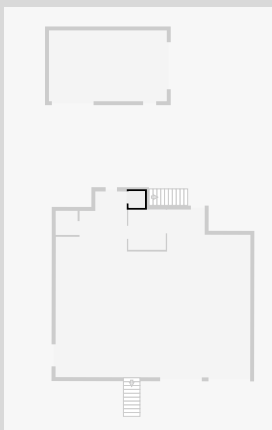

## Storage

Width: 2.39 m  
 Length: 2.57 m  
 Area: 6.13 m<sup>2</sup>  
 Perimeter: 9.91 m

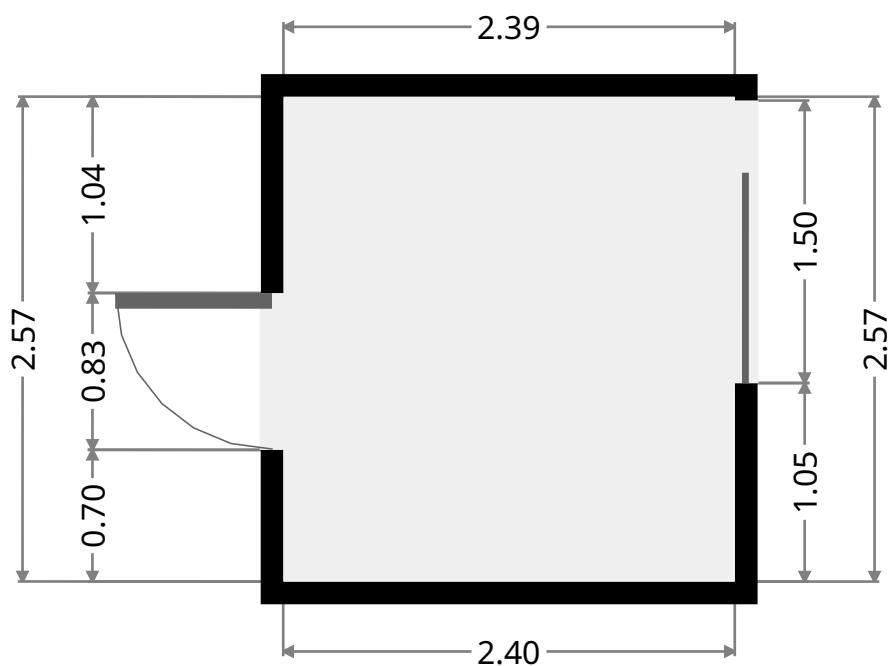
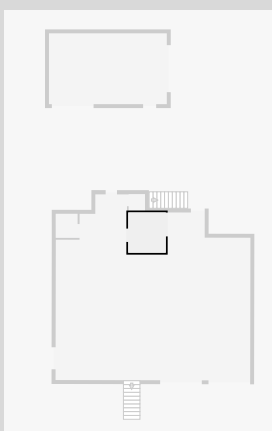

# 127 Edington Street

## Closet

Width: 1.39 m  
Length: 1.53 m  
Area: 2.14 m<sup>2</sup>  
Perimeter: 5.86 m

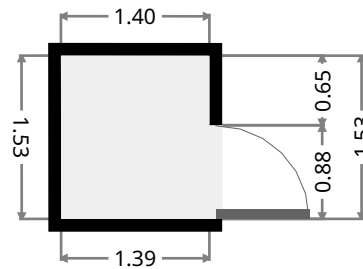
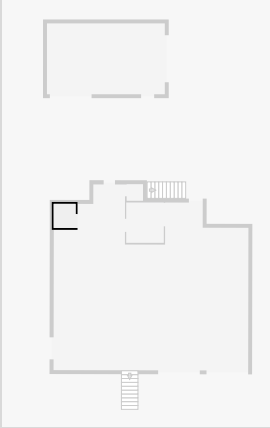

## Shed

Width: 4.51 m  
Length: 7.50 m  
Area: 33.78 m<sup>2</sup>  
Perimeter: 24.01 m

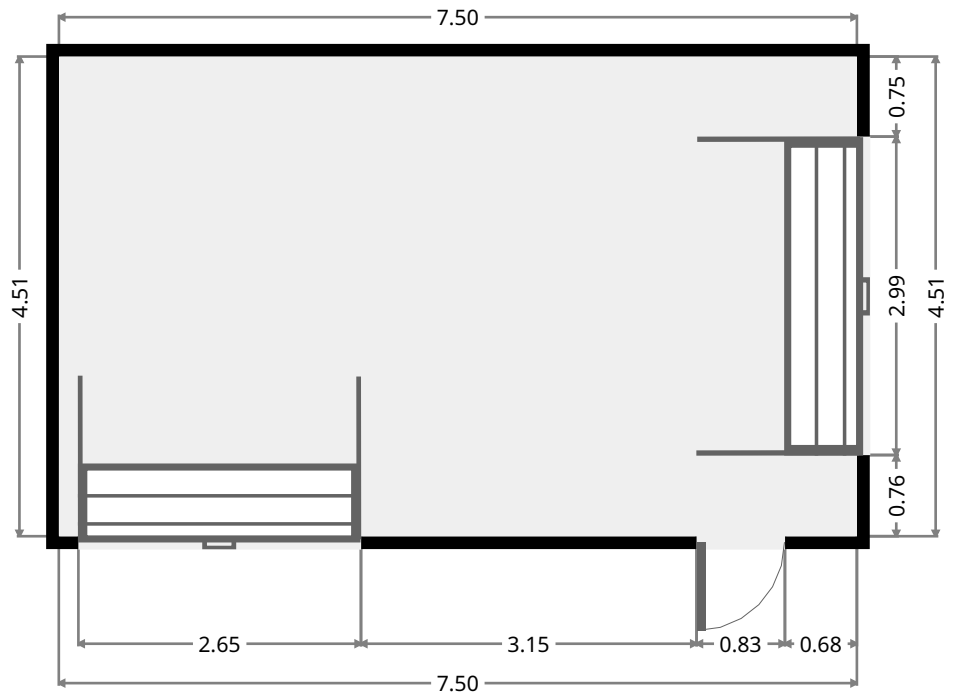
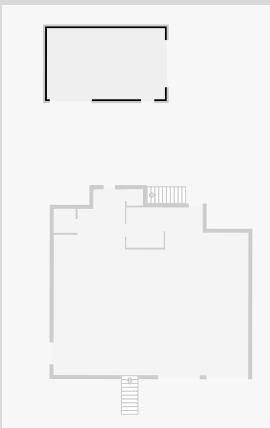

THIS FLOORPLAN IS PROVIDED WITHOUT WARRANTY OF ANY KIND. SENSOPIA DISCLAIMS ANY WARRANTY INCLUDING, WITHOUT LIMITATION, SATISFACTORY QUALITY OR ACCURACY OF DIMENSIONS.

