

# 100 Bremner Street

## Ground Floor

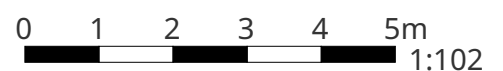

THIS FLOORPLAN IS PROVIDED WITHOUT WARRANTY OF ANY KIND. SENSOPIA DISCLAIMS ANY WARRANTY INCLUDING, WITHOUT LIMITATION, SATISFACTORY QUALITY OR ACCURACY OF DIMENSIONS.



# 100 Bremner Street

## Rumpus Room

Width: 6.37 m  
 Length: 8.39 m  
 Area: 46.13 m<sup>2</sup>  
 Perimeter: 29.53 m

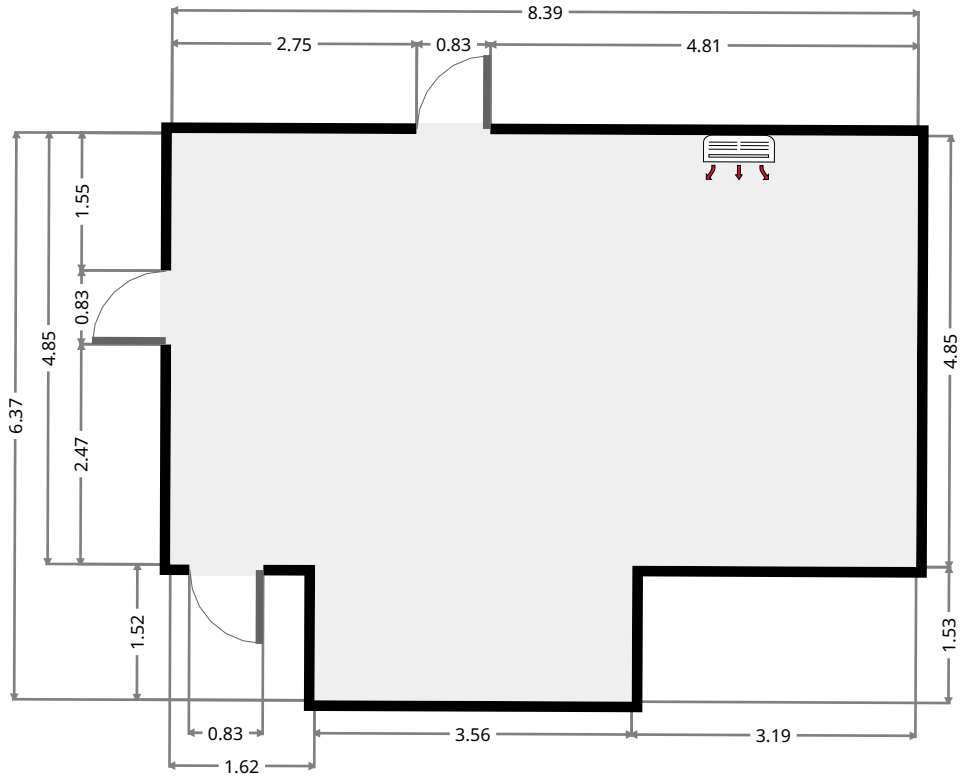
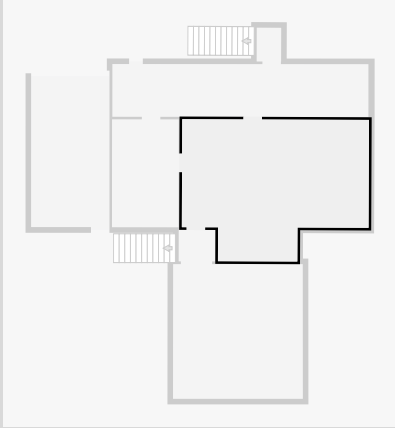

## Bedroom

Width: 2.99 m  
 Length: 4.85 m  
 Area: 14.52 m<sup>2</sup>  
 Perimeter: 15.69 m

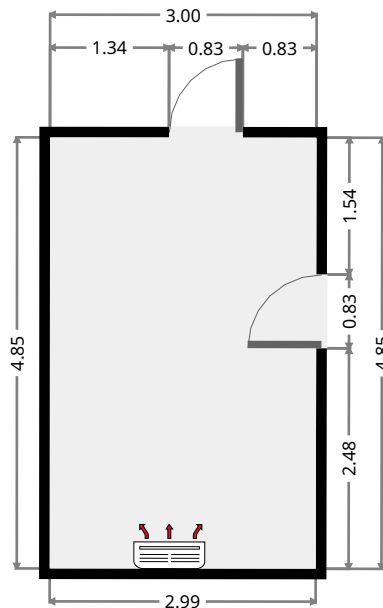
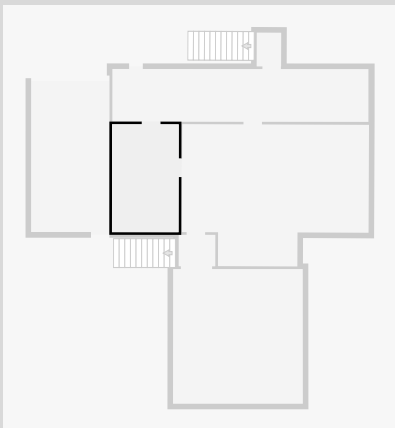

# 100 Bremner Street

## Laundry Room

Width: 2.37 m  
Length: 11.50 m  
Area: 27.27 m<sup>2</sup>  
Perimeter: 27.75 m

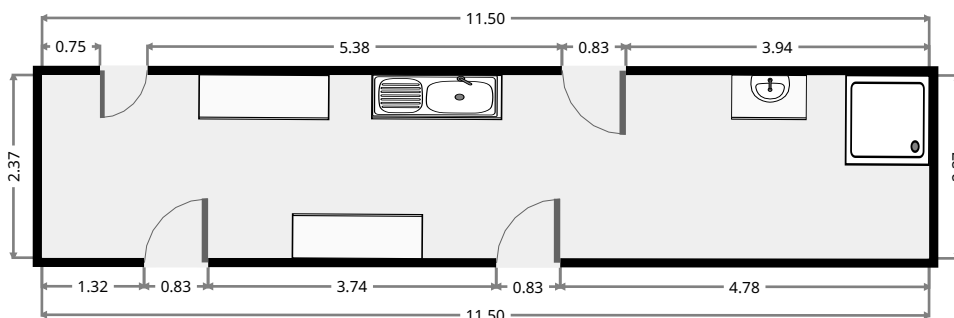
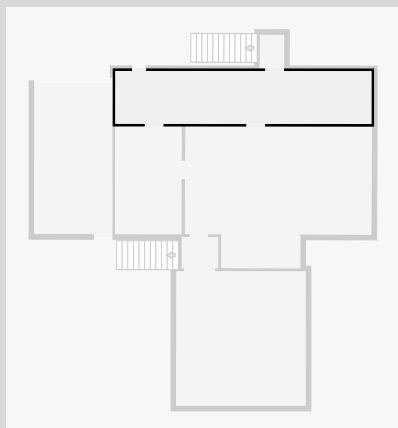

THIS FLOORPLAN IS PROVIDED WITHOUT WARRANTY OF ANY KIND. SENSOPIA DISCLAIMS ANY WARRANTY INCLUDING, WITHOUT LIMITATION, SATISFACTORY QUALITY OR ACCURACY OF DIMENSIONS.



# 100 Bremner Street

## Toilet

Width: 1.10 m  
Length: 1.52 m  
Area: 1.67 m<sup>2</sup>  
Perimeter: 5.24 m

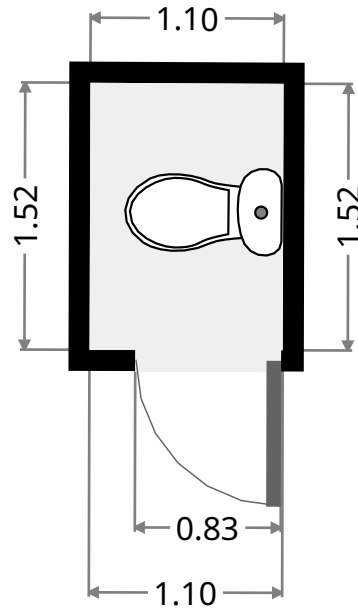
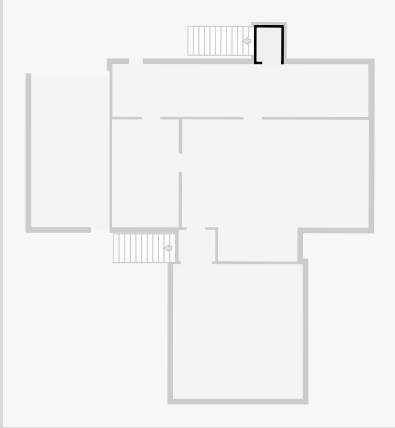

•  
Width: 1.41 m  
Length: 1.65 m  
Area: 2.33 m<sup>2</sup>  
Perimeter: 6.12 m

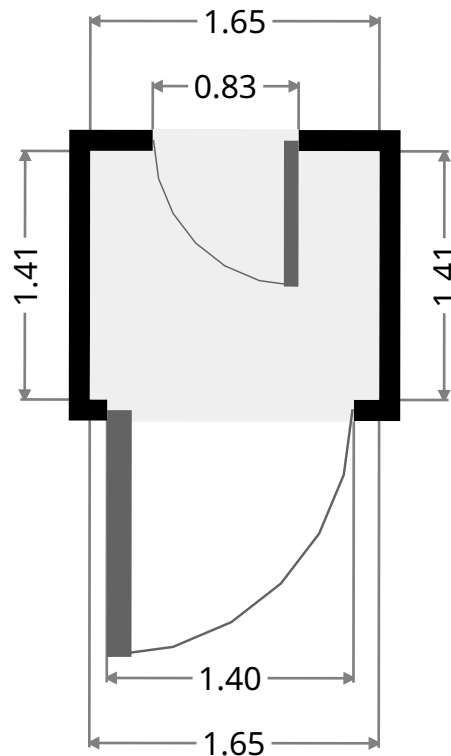
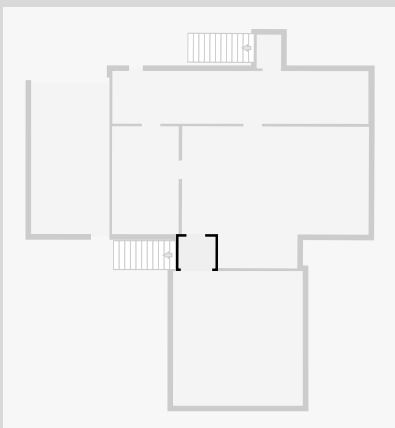

# 100 Bremner Street

## Awning

Width: 3.52 m  
Length: 6.66 m  
Area: 23.45 m<sup>2</sup>  
Perimeter: 20.36 m

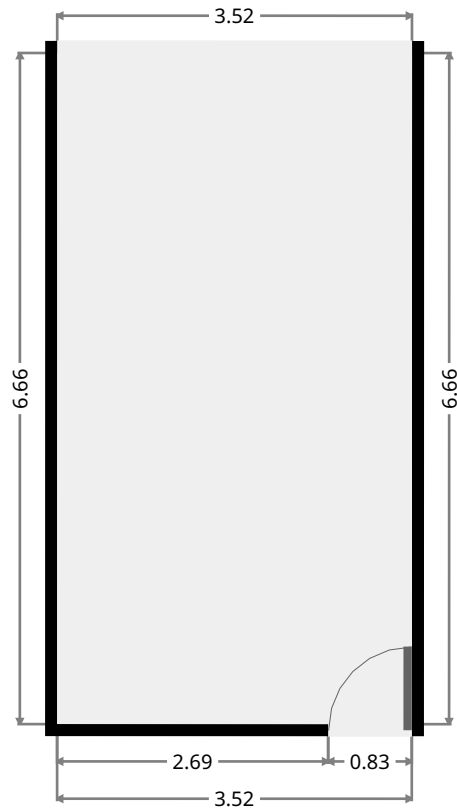
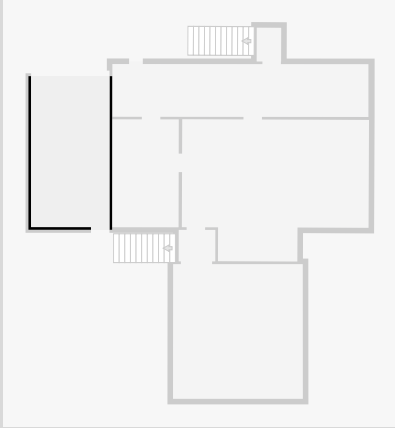

## Carport

Width: 5.82 m  
Length: 6.05 m  
Area: 35.26 m<sup>2</sup>  
Perimeter: 23.76 m

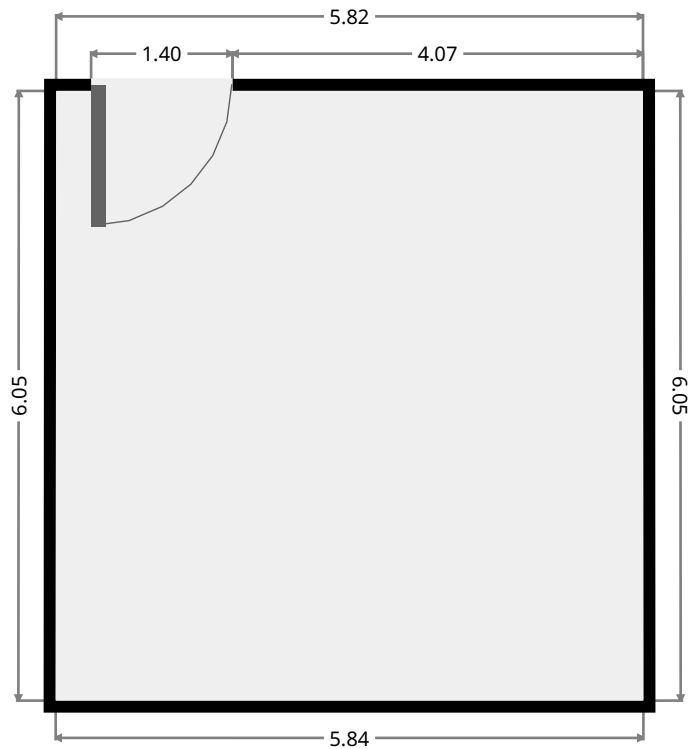
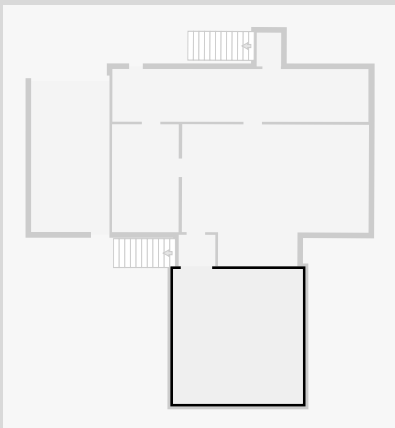

# 100 Bremner Street

## 1st Floor



THIS FLOORPLAN IS PROVIDED WITHOUT WARRANTY OF ANY KIND. SENSOPIA DISCLAIMS ANY WARRANTY INCLUDING, WITHOUT LIMITATION, SATISFACTORY QUALITY OR ACCURACY OF DIMENSIONS.



# 100 Bremner Street

## Kitchen

Width: 3.30 m  
 Length: 3.48 m  
 Area: 9.89 m<sup>2</sup>  
 Perimeter: 13.53 m

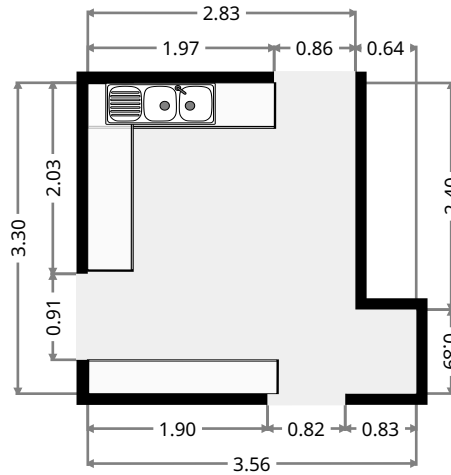
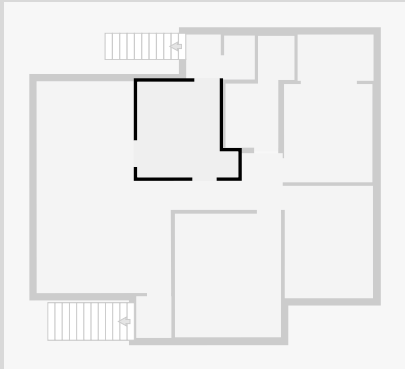

## Living Room

Width: 4.63 m  
 Length: 7.30 m  
 Area: 29.34 m<sup>2</sup>  
 Perimeter: 23.82 m

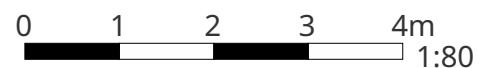
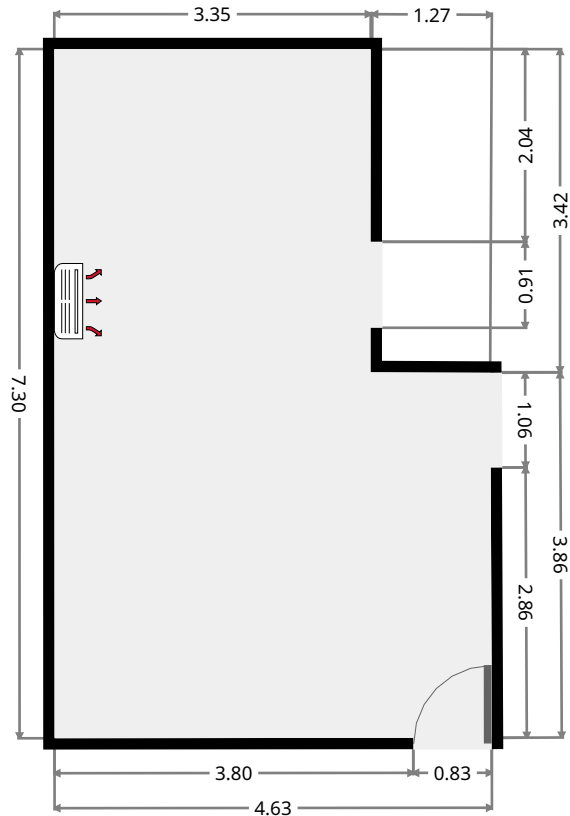
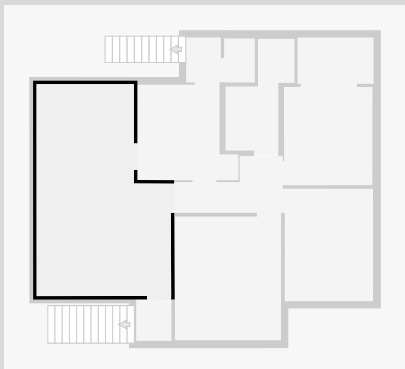

THIS FLOORPLAN IS PROVIDED WITHOUT WARRANTY OF ANY KIND. SENSOPIA DISCLAIMS ANY WARRANTY INCLUDING, WITHOUT LIMITATION, SATISFACTORY QUALITY OR ACCURACY OF DIMENSIONS.

# 100 Bremner Street

•  
 Width: 1.21 m  
 Length: 1.44 m  
 Area: 1.74 m<sup>2</sup>  
 Perimeter: 5.29 m

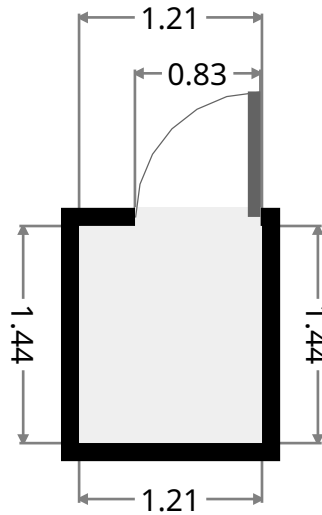
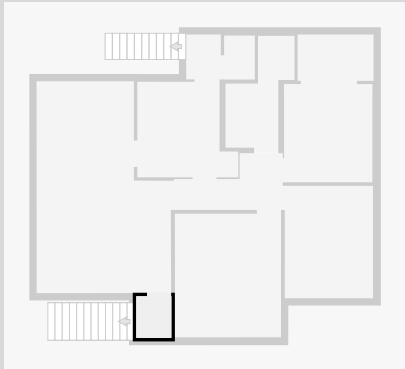

## Hall

Width: 1.95 m  
 Length: 3.76 m  
 Area: 5.30 m<sup>2</sup>  
 Perimeter: 11.41 m

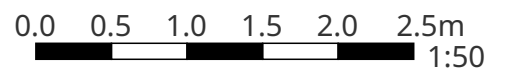
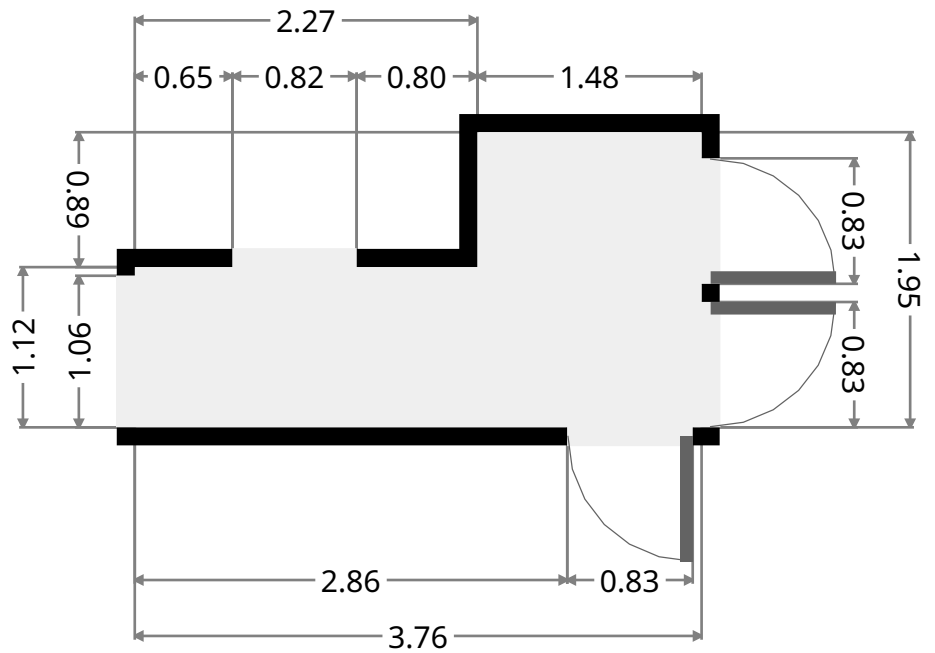
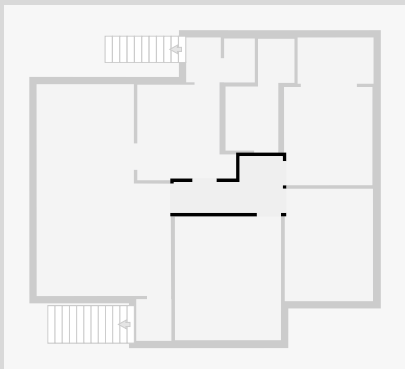

THIS FLOORPLAN IS PROVIDED WITHOUT WARRANTY OF ANY KIND. SENSOPIA DISCLAIMS ANY WARRANTY INCLUDING, WITHOUT LIMITATION, SATISFACTORY QUALITY OR ACCURACY OF DIMENSIONS.



# 100 Bremner Street

## Bedroom

Width: 3.65 m  
 Length: 4.25 m  
 Area: 15.54 m<sup>2</sup>  
 Perimeter: 15.81 m

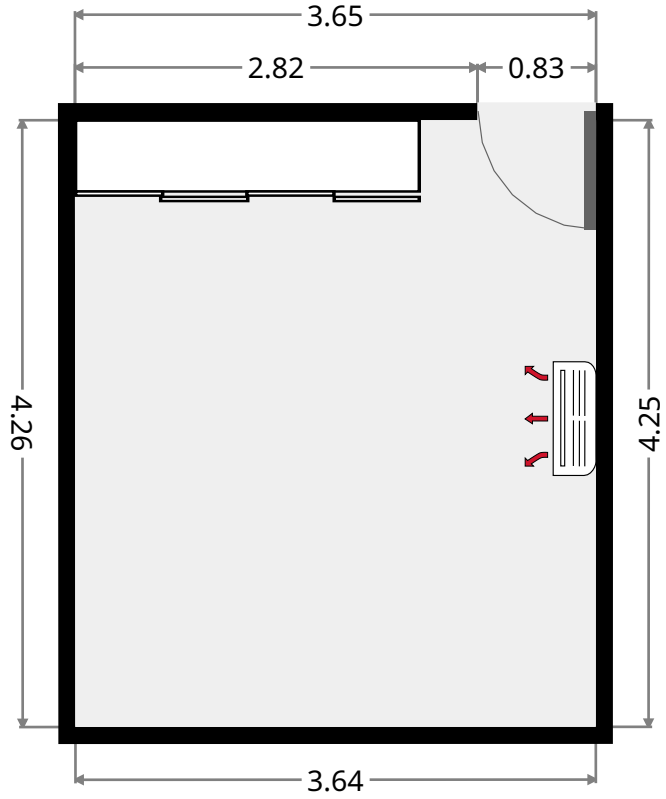
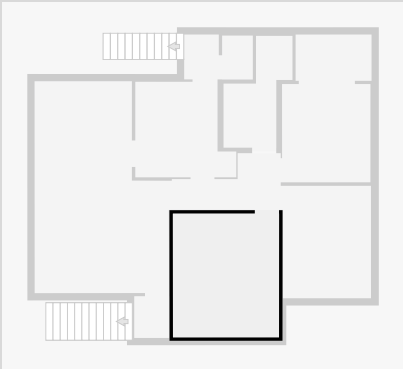

## Bedroom

Width: 3.04 m  
 Length: 3.87 m  
 Area: 11.75 m<sup>2</sup>  
 Perimeter: 13.81 m

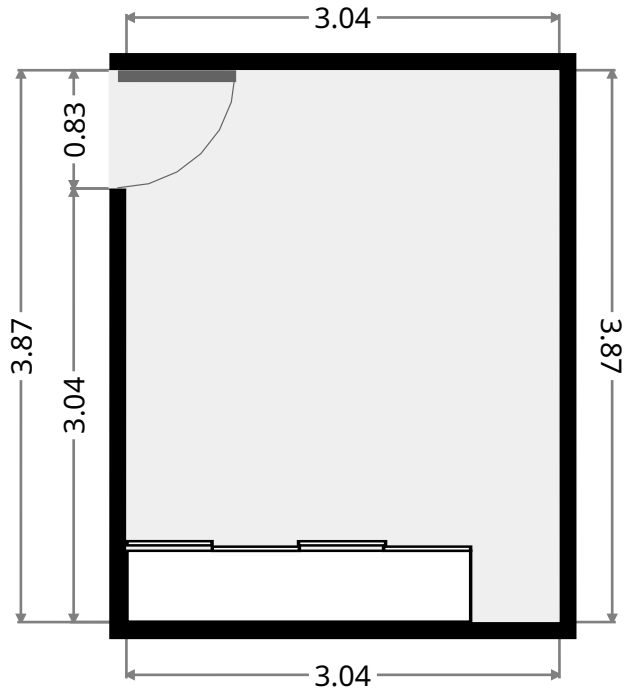
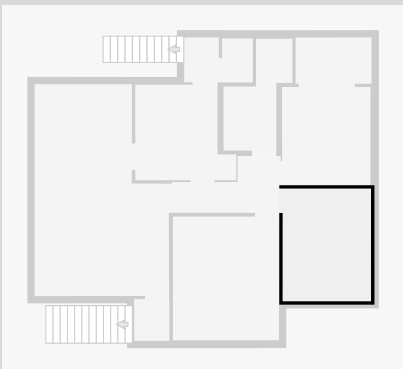

THIS FLOORPLAN IS PROVIDED WITHOUT WARRANTY OF ANY KIND. SENSOPIA DISCLAIMS ANY WARRANTY INCLUDING, WITHOUT LIMITATION, SATISFACTORY QUALITY OR ACCURACY OF DIMENSIONS.

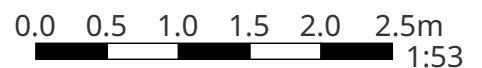

# 100 Bremner Street

## Bedroom

Width: 3.04 m  
 Length: 3.38 m  
 Area: 10.29 m<sup>2</sup>  
 Perimeter: 12.85 m

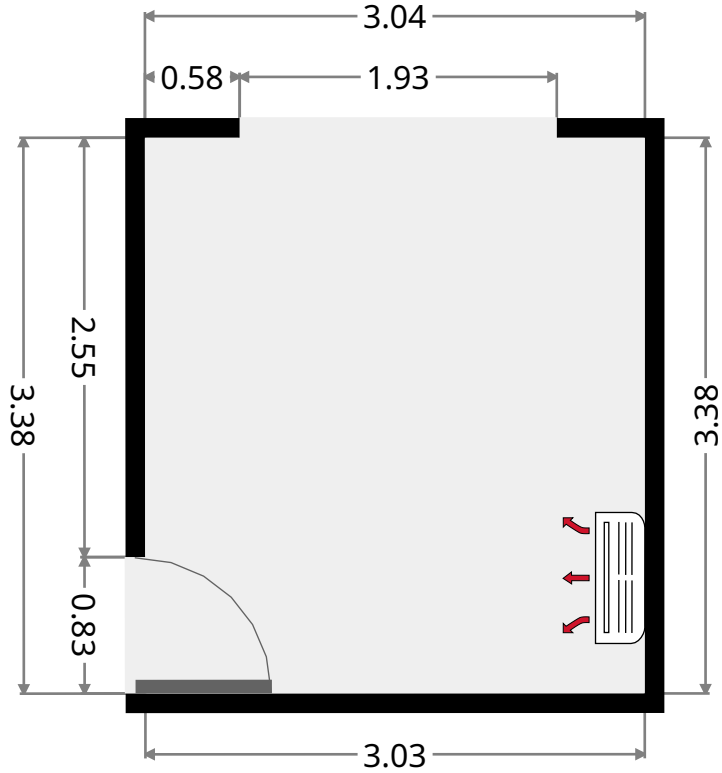
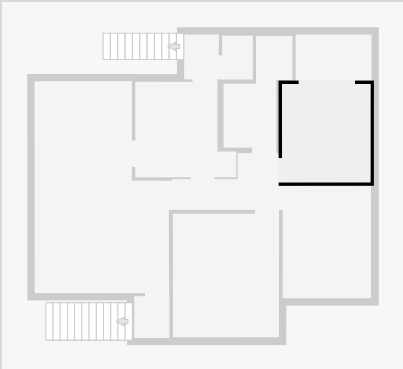

## Sunroom

Width: 1.60 m  
 Length: 2.61 m  
 Area: 4.16 m<sup>2</sup>  
 Perimeter: 8.41 m

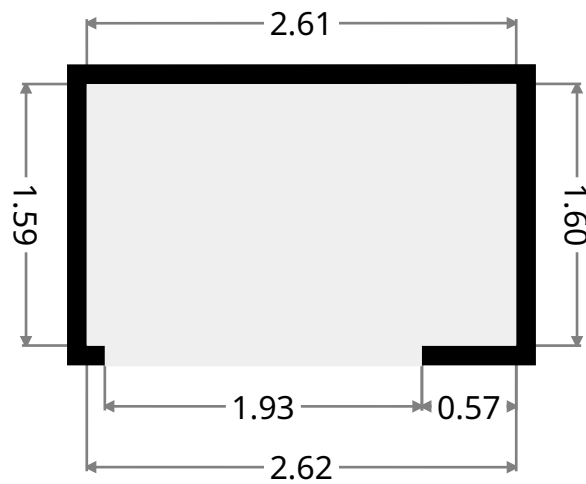
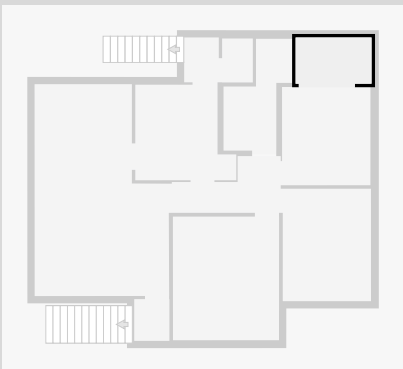

# 100 Bremner Street

## Bathroom

Width: 1.82 m  
 Length: 2.20 m  
 Area: 4.01 m<sup>2</sup>  
 Perimeter: 8.05 m

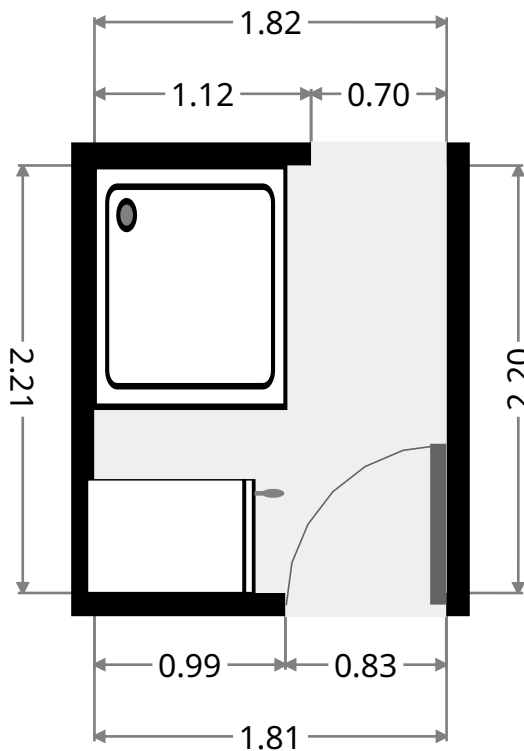
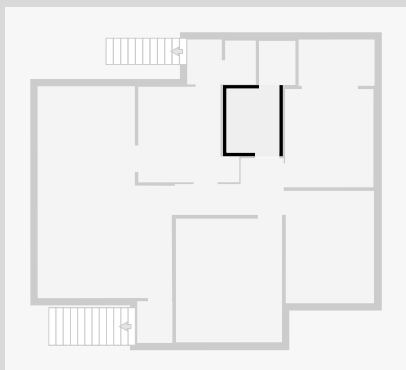

•  
 Width: 1.26 m  
 Length: 1.51 m  
 Area: 1.91 m<sup>2</sup>  
 Perimeter: 5.55 m

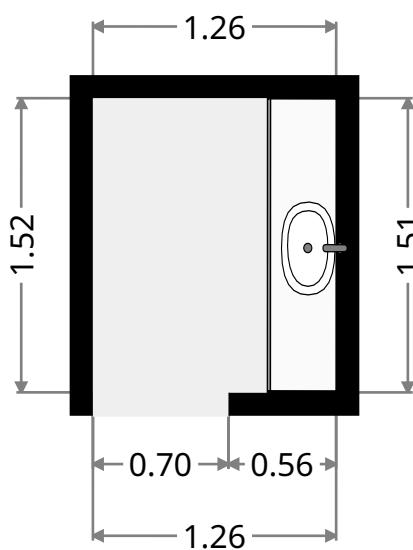
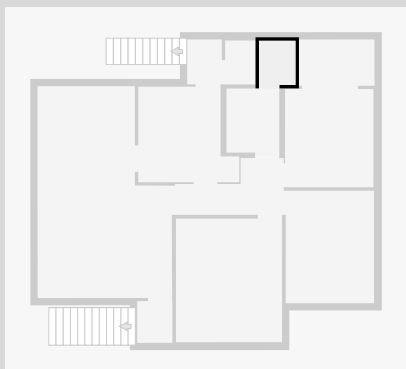

# 100 Bremner Street

## Toilet

Width: 1.06 m  
Length: 1.51 m  
Area: 1.60 m<sup>2</sup>  
Perimeter: 5.14 m

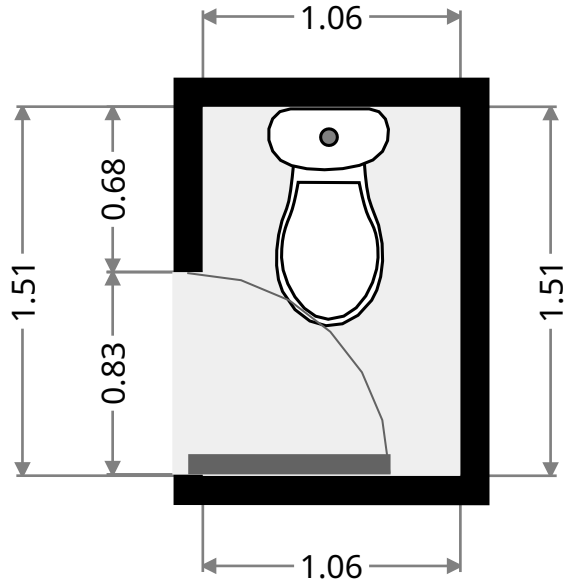
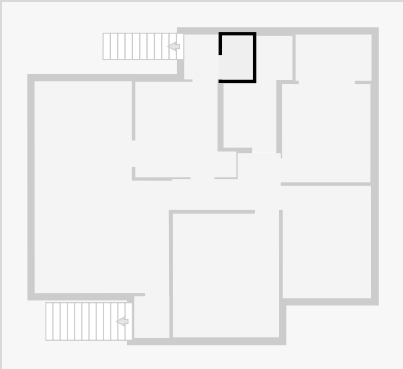

## Hall

Width: 1.19 m  
Length: 1.55 m  
Area: 1.84 m<sup>2</sup>  
Perimeter: 5.47 m

