

# 10 Buckle Street

## Ground Floor

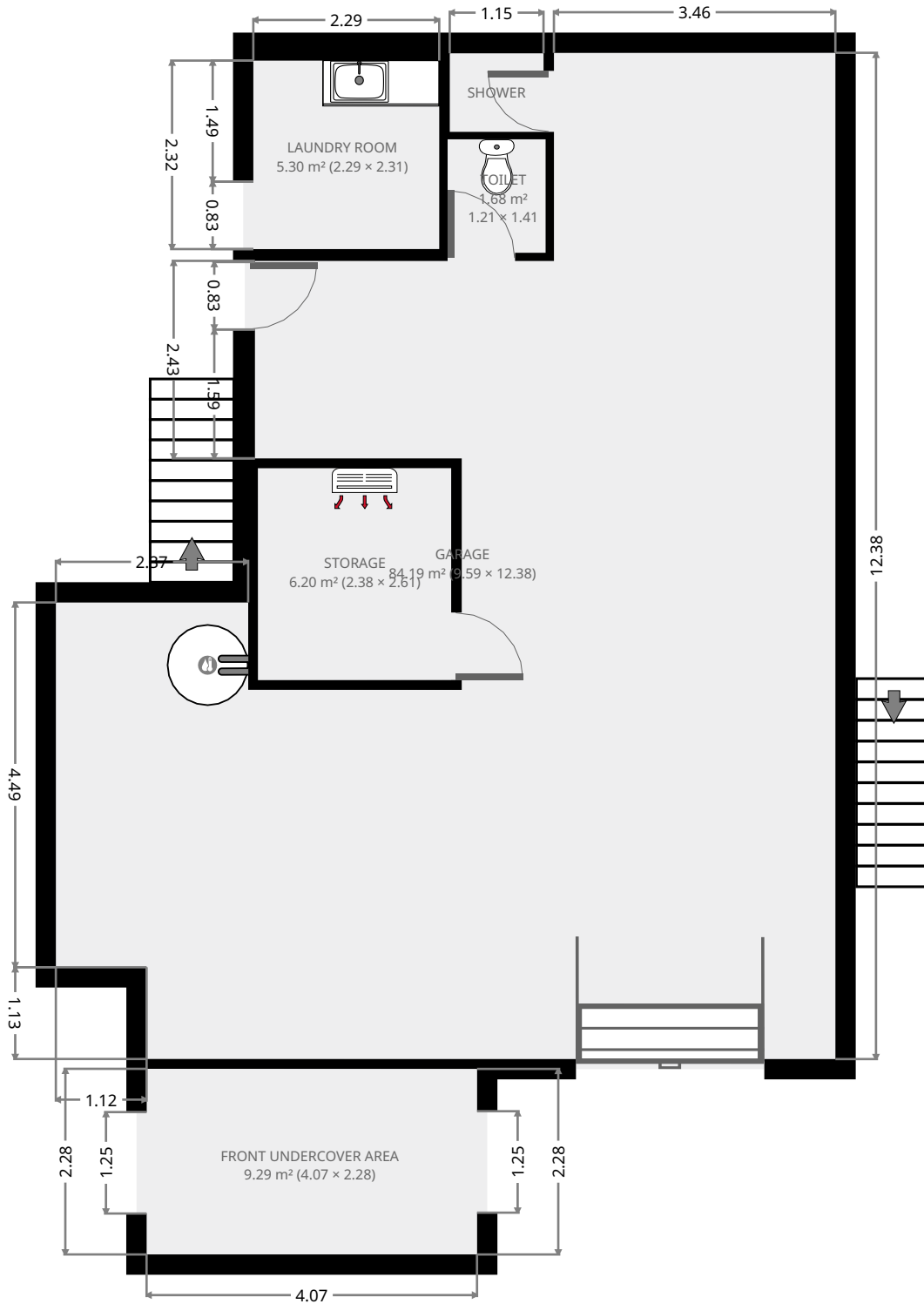

THIS FLOORPLAN IS PROVIDED WITHOUT WARRANTY OF ANY KIND. SENSOPIA DISCLAIMS ANY WARRANTY INCLUDING, WITHOUT LIMITATION, SATISFACTORY QUALITY OR ACCURACY OF DIMENSIONS.



# 10 Buckle Street

## Garage

Width: 9.59 m  
Length: 12.38 m  
Area: 84.19 m<sup>2</sup>  
Perimeter: 51.19 m

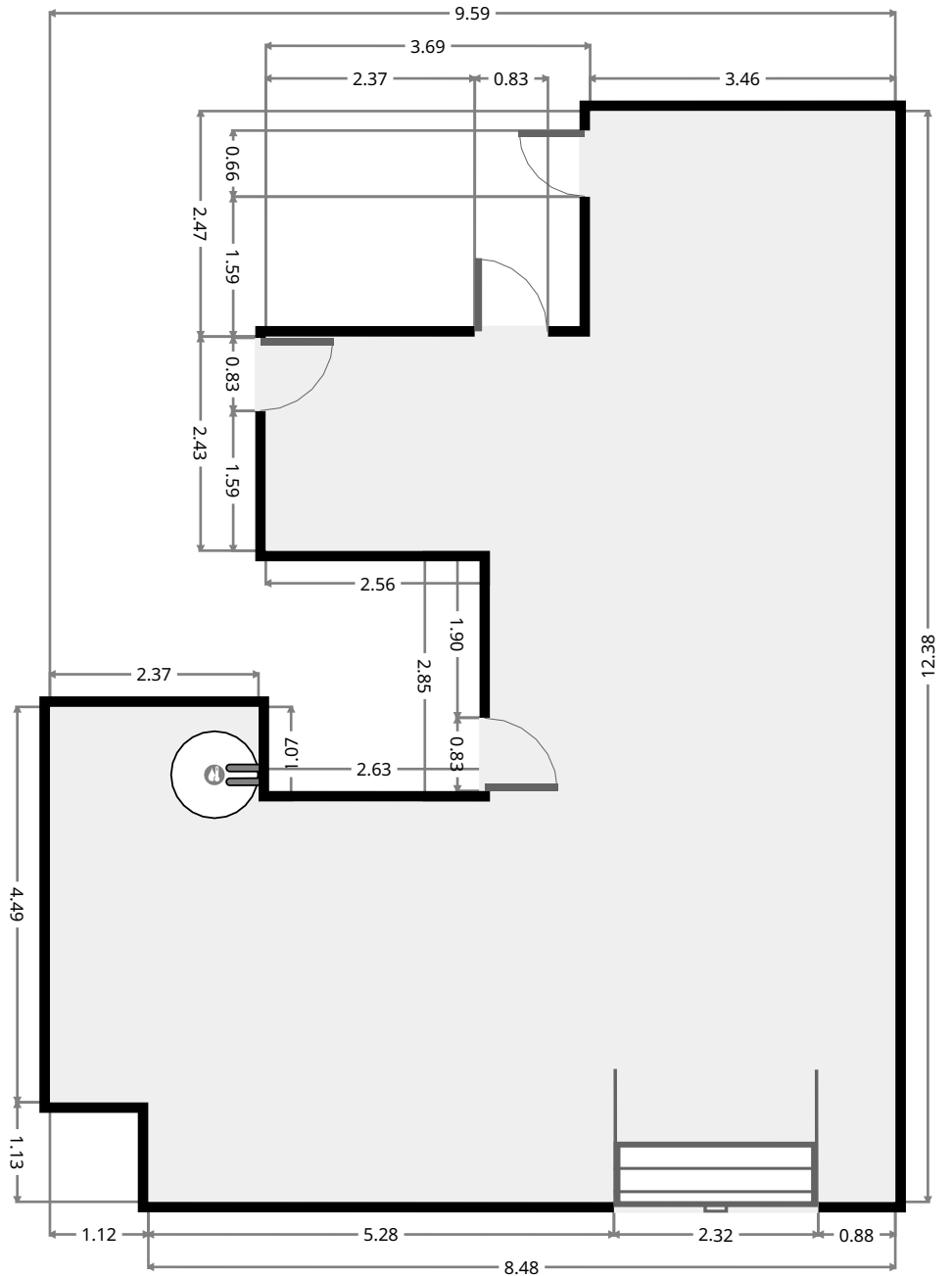
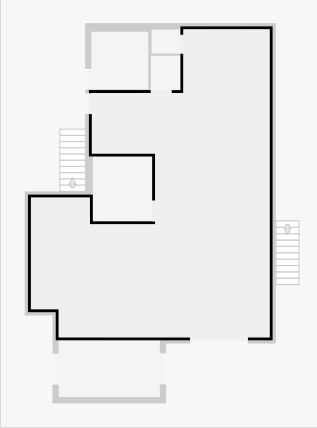

THIS FLOORPLAN IS PROVIDED WITHOUT WARRANTY OF ANY KIND. SENSOPIA DISCLAIMS ANY WARRANTY INCLUDING, WITHOUT LIMITATION, SATISFACTORY QUALITY OR ACCURACY OF DIMENSIONS.



# 10 Buckle Street

## Storage

Width: 2.38 m  
Length: 2.61 m  
Area: 6.20 m<sup>2</sup>  
Perimeter: 9.97 m

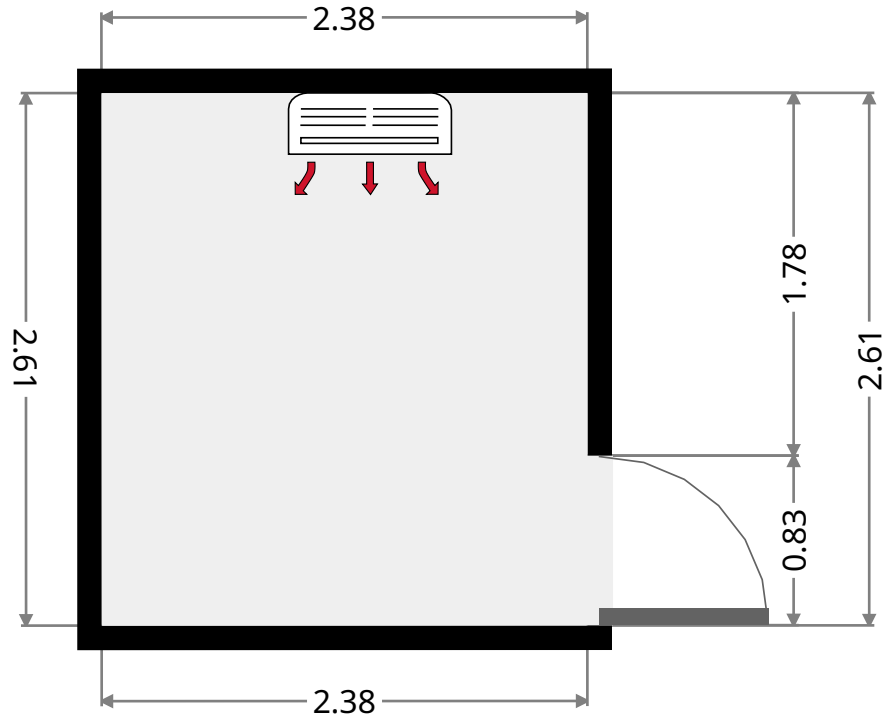
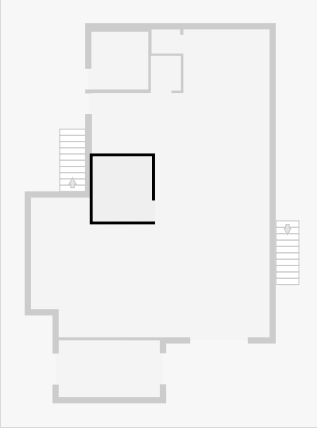

## Toilet

Width: 1.21 m  
Length: 1.41 m  
Area: 1.68 m<sup>2</sup>  
Perimeter: 5.20 m

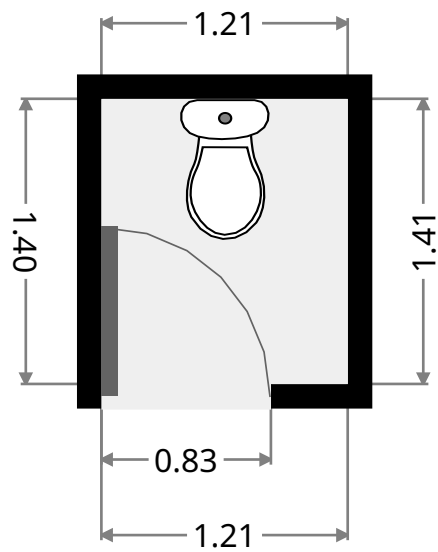
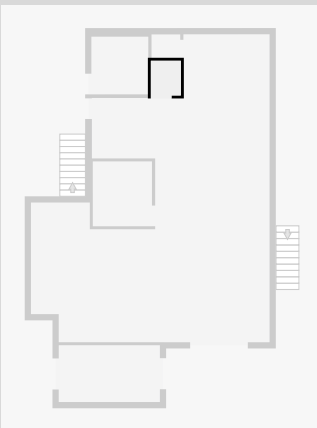

# 10 Buckle Street

## Shower

Width: 0.98 m  
Length: 1.15 m  
Area: 1.11 m<sup>2</sup>  
Perimeter: 4.24 m

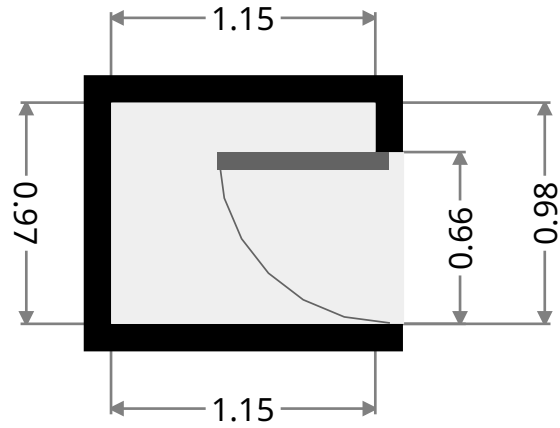
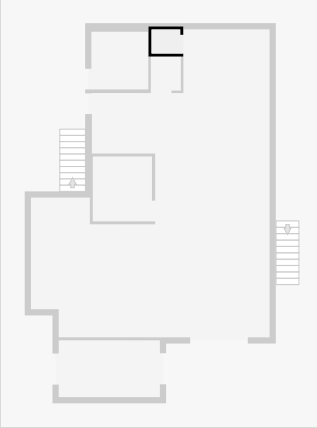

## Laundry Room

Width: 2.29 m  
Length: 2.31 m  
Area: 5.30 m<sup>2</sup>  
Perimeter: 9.21 m

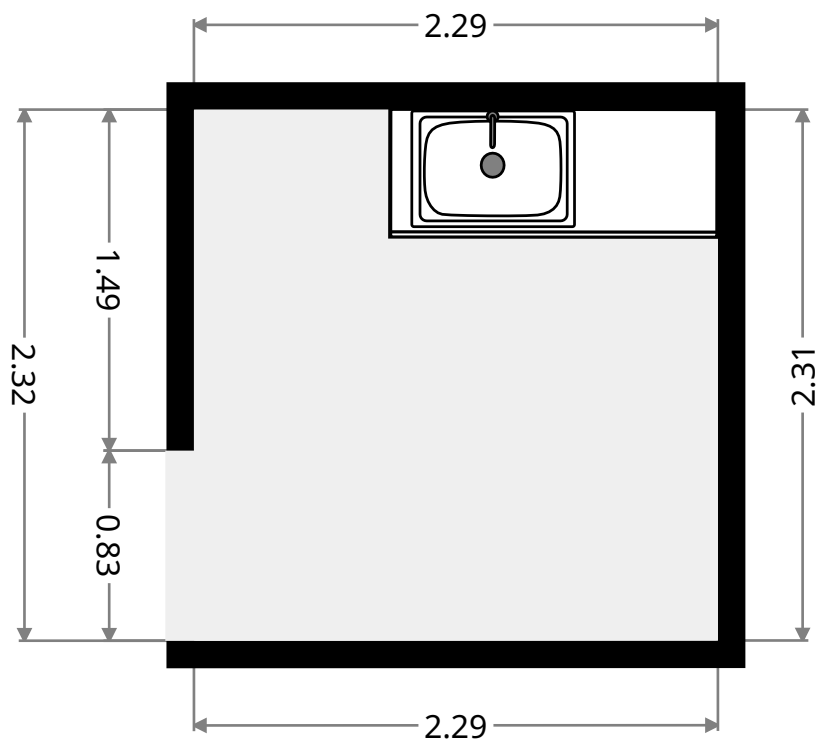
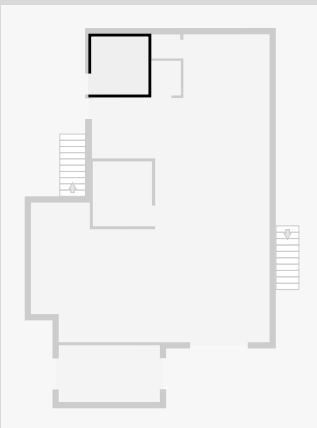

# 10 Buckle Street

## Front UnderCover Area

Width: 2.28 m  
Length: 4.07 m  
Area: 9.29 m<sup>2</sup>  
Perimeter: 12.70 m

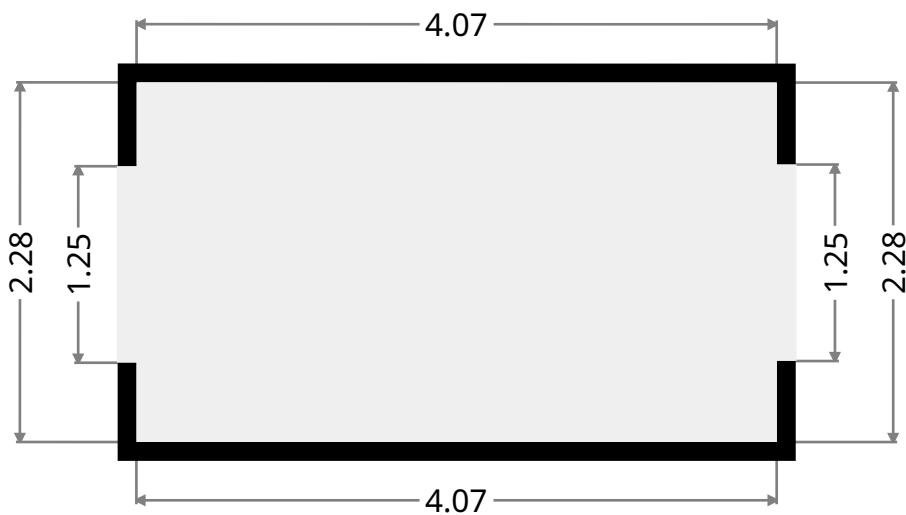
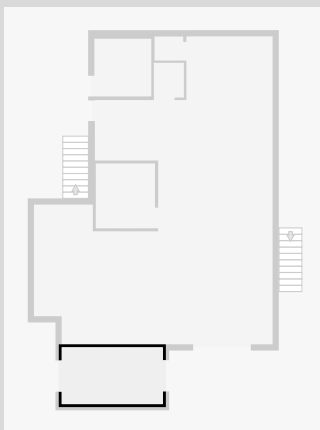

# 10 Buckle Street

## 1st Floor

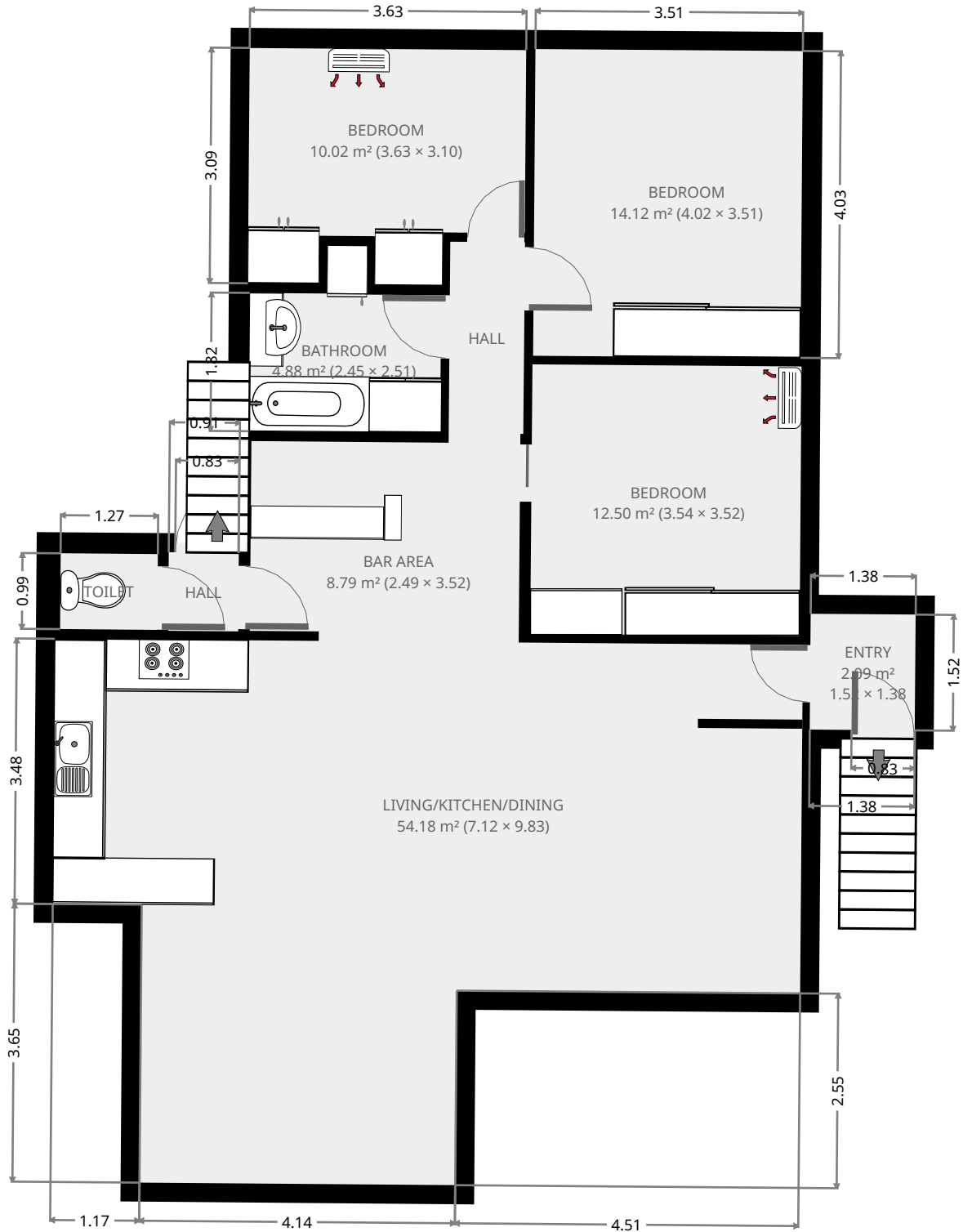

THIS FLOORPLAN IS PROVIDED WITHOUT WARRANTY OF ANY KIND. SENSOPIA DISCLAIMS ANY WARRANTY INCLUDING, WITHOUT LIMITATION, SATISFACTORY QUALITY OR ACCURACY OF DIMENSIONS.



# 10 Buckle Street

## Living/Kitchen/Dining

Width: 7.12 m  
 Length: 9.83 m  
 Area: 54.18 m<sup>2</sup>  
 Perimeter: 33.88 m  
 Ceiling Height: 2.17 m

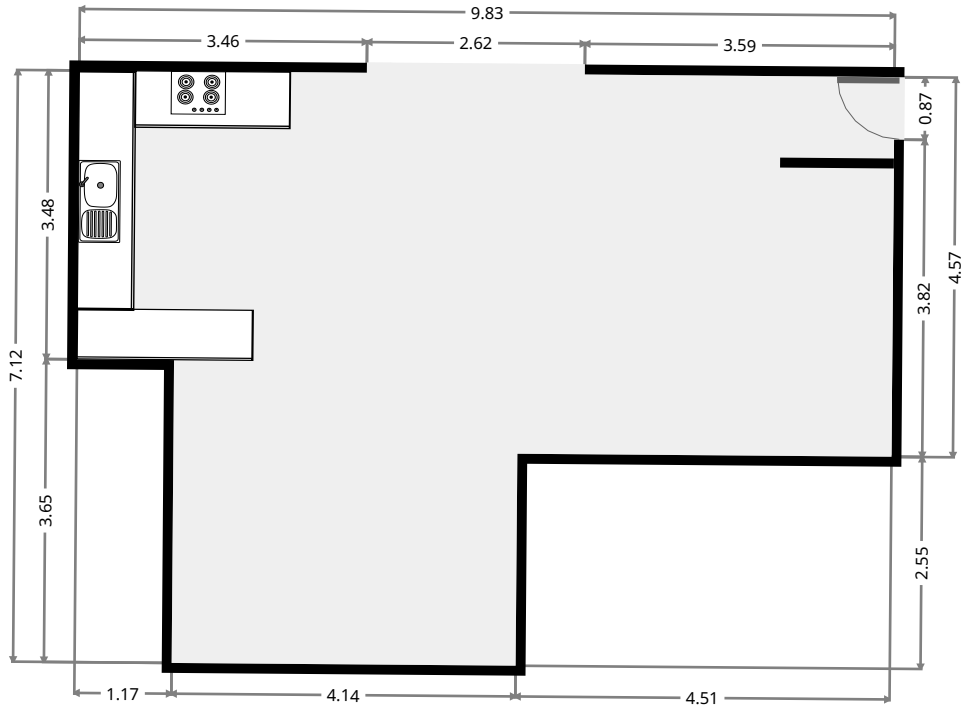
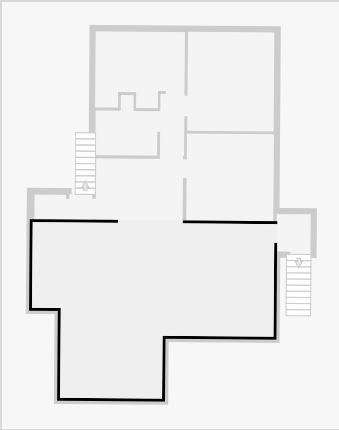

## Bar Area

Width: 2.49 m  
 Length: 3.52 m  
 Area: 8.79 m<sup>2</sup>  
 Perimeter: 12.04 m

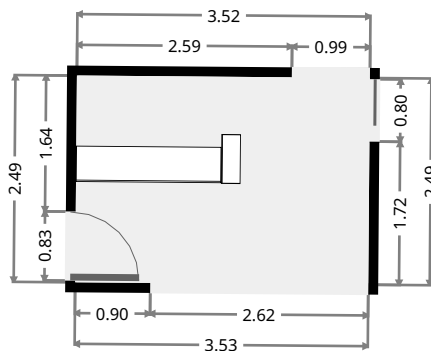
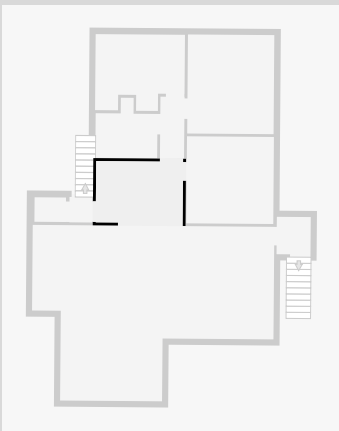

# 10 Buckle Street

## Bedroom

Width: 3.52 m  
 Length: 3.54 m  
 Area: 12.50 m<sup>2</sup>  
 Perimeter: 14.14 m

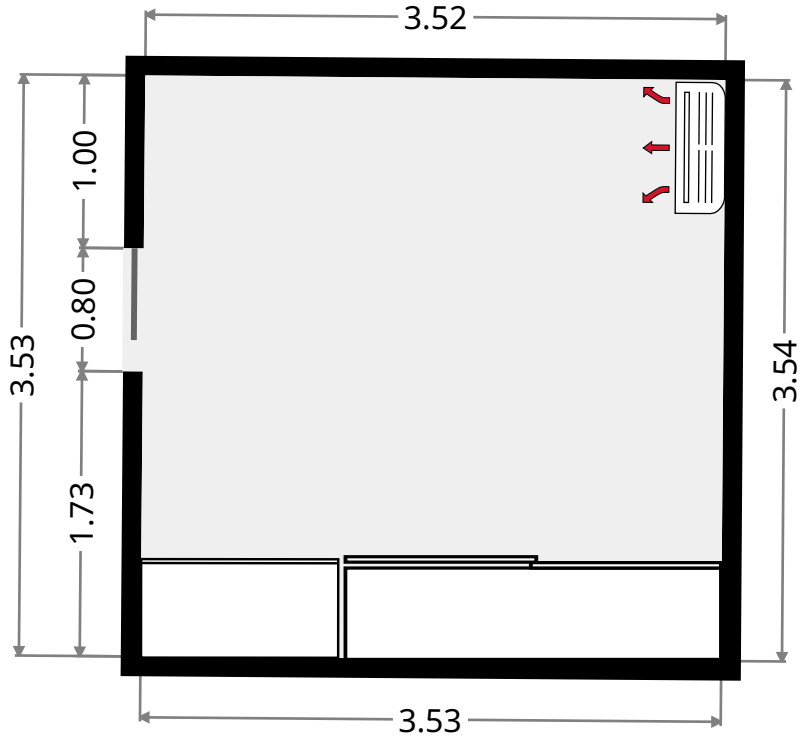
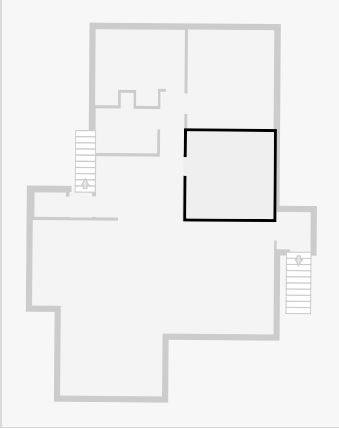

## Hall

Width: 0.99 m  
 Length: 2.51 m  
 Area: 2.46 m<sup>2</sup>  
 Perimeter: 6.99 m

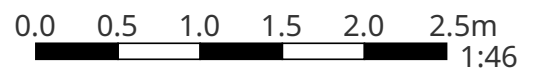
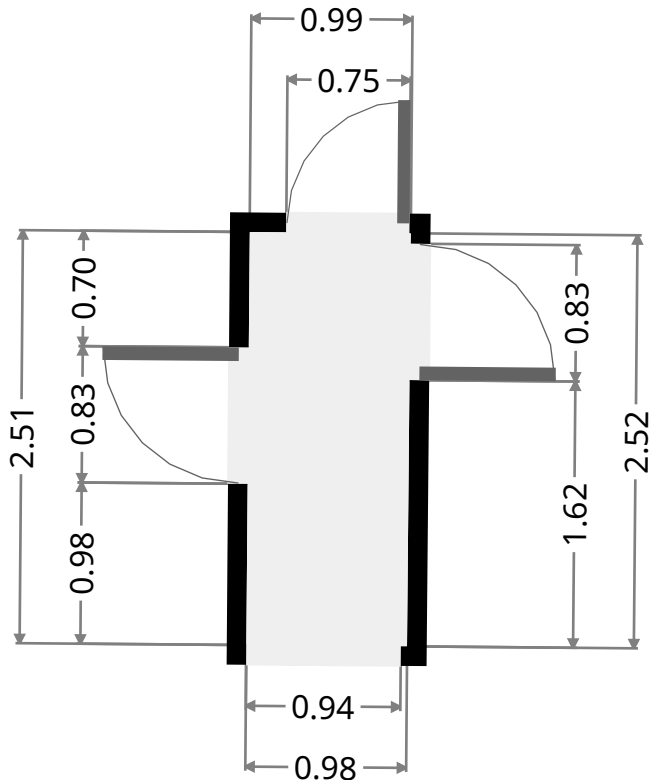
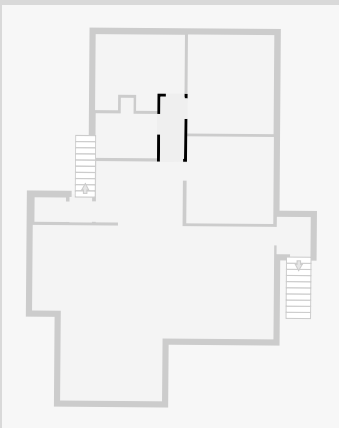

THIS FLOORPLAN IS PROVIDED WITHOUT WARRANTY OF ANY KIND. SENSOPIA DISCLAIMS ANY WARRANTY INCLUDING, WITHOUT LIMITATION, SATISFACTORY QUALITY OR ACCURACY OF DIMENSIONS.



# 10 Buckle Street

## Bathroom

Width: 2.45 m  
 Length: 2.51 m  
 Area: 4.88 m<sup>2</sup>  
 Perimeter: 9.92 m

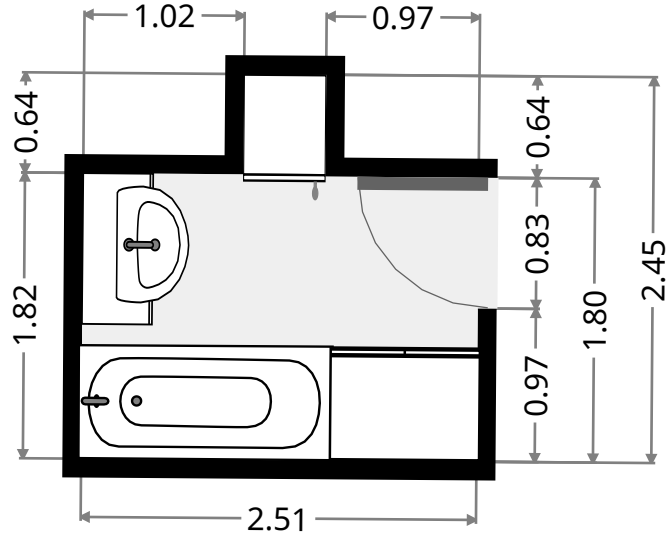
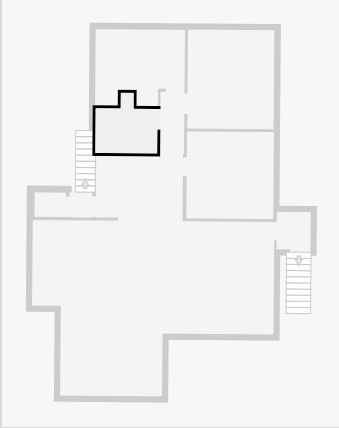

## Bedroom

Width: 3.51 m  
 Length: 4.02 m  
 Area: 14.12 m<sup>2</sup>  
 Perimeter: 15.07 m

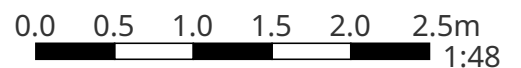
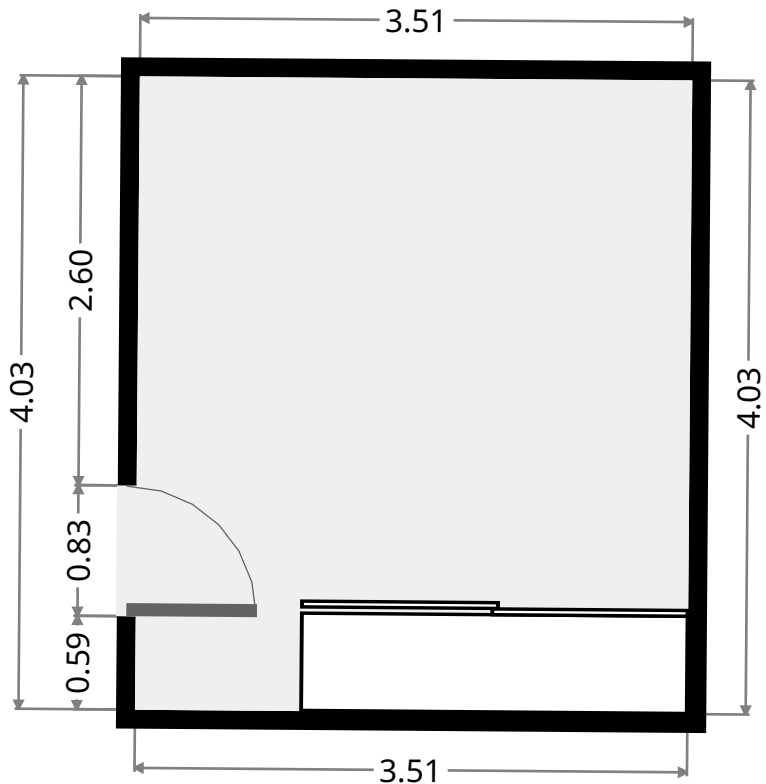
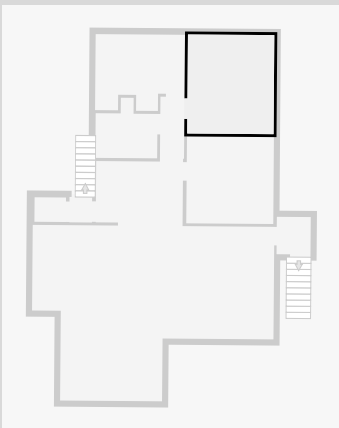

# 10 Buckle Street

## Bedroom

Width: 3.10 m  
 Length: 3.63 m  
 Area: 10.02 m<sup>2</sup>  
 Perimeter: 14.73 m

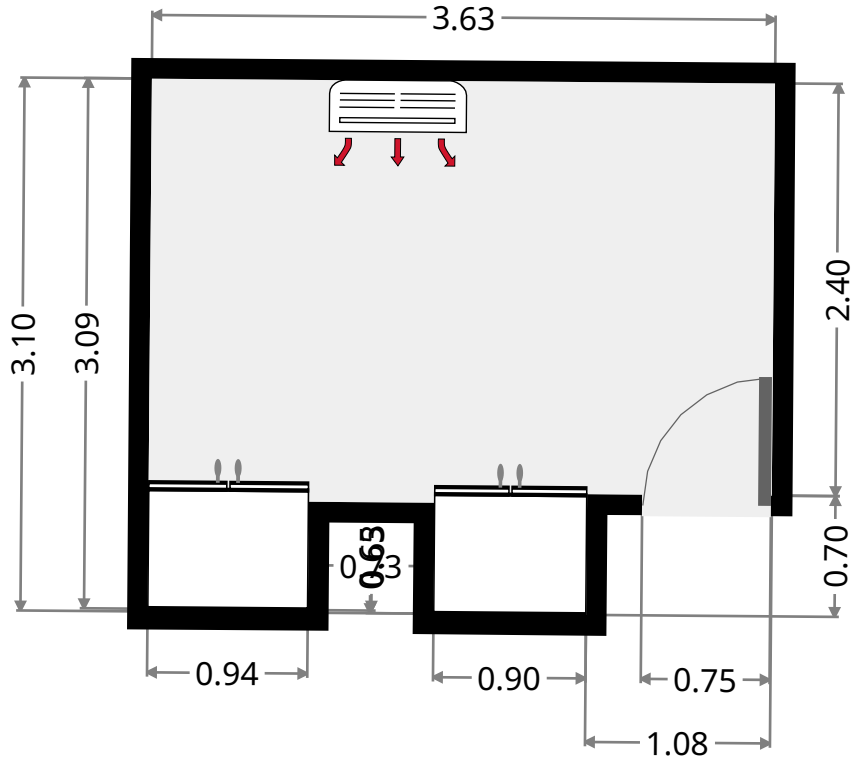
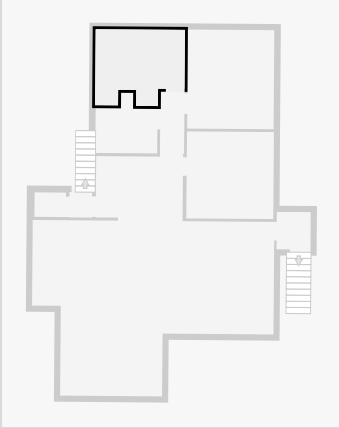

## Entry

Width: 1.38 m  
 Length: 1.52 m  
 Area: 2.09 m<sup>2</sup>  
 Perimeter: 5.79 m

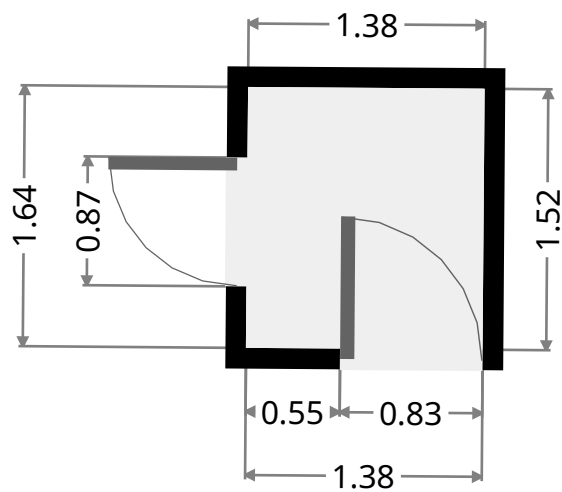
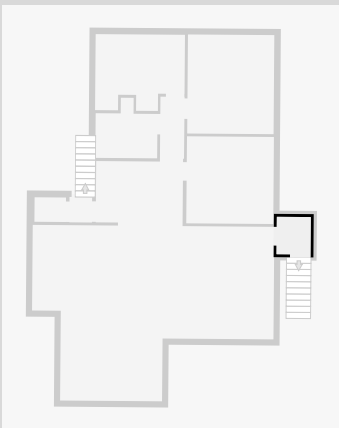

# 10 Buckle Street

## Hall

Width: 0.91 m  
 Length: 1.03 m  
 Area: 0.95 m<sup>2</sup>  
 Perimeter: 3.90 m

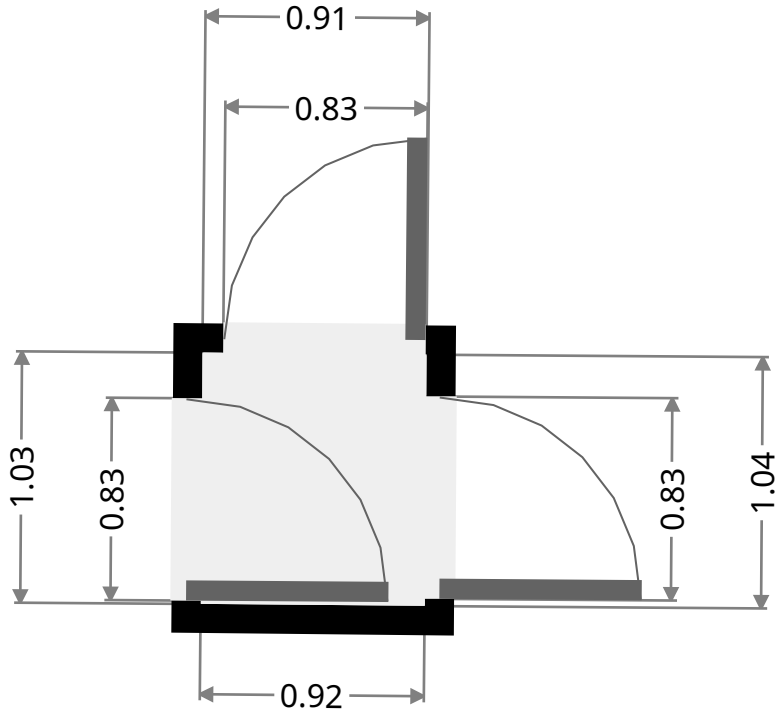
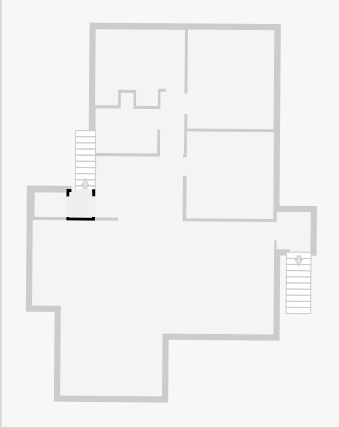

## Toilet

Width: 0.99 m  
 Length: 1.27 m  
 Area: 1.27 m<sup>2</sup>  
 Perimeter: 4.54 m

